

Features

Switching Regulator

- 8A industrial grade non-isolated DC/DC
- Compact, industry standard 1/32nd brick format
- Efficiency up to 98%
- 9-53V input voltage
- 3.3-16.5V adjustable output voltage



RPMA-8.0/OF

8 Amp
1/32 Brick
Open Frame
Single Output

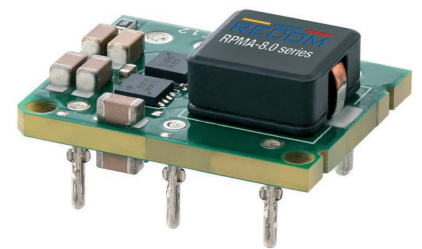

Description

The RPMA5.0-8.0/OF is a high efficiency non-isolated buck converter with up to 8A output current in a 1/32nd brick footprint. The input voltage range is from 9-53VDC, and the output voltage is trimmable from 3.3-16.5VDC via a fixed trim resistor. Typical applications for these highly compact, reliable converters include distributed power architecture voltage conversion from 12, 24, 28, 36, and 48V bus systems for industrial, medical, test and measurement, and telecom equipment. With an efficiency up to 98%, the converter operates at temperatures from -40°C to +85°C and comes with RECOM's standard 3 year warranty.

Selection Guide

Part Number	Input Voltage Range [VDC]	Output Voltage Adjustment Range ⁽¹⁾ [VDC]	Max. Output Current [A]	Efficiency typ. ⁽²⁾ [%]
RPMA5.0-8.0/OF	9-53	3.3-16.5	8	96.5

Notes:

Note1: External trim resistor is mandatory, do not leave floating

Note2: Efficiency tested at $V_{IN}= 24VDC$, full load and $V_{OUT}= 24VDC$

UL/CSA 62368-1 certified

Model Numbering

RPMA5.0-8.0/OF



Specifications (measured @ Ta= 25°C, full load and after warm-up unless otherwise stated)

BASIC CHARACTERISTICS

Parameter	Condition	Min.	Typ.	Max.
Absolute Maximum Input Voltage		-0.25VDC		55VDC
Input Voltage Range		9VDC		53VDC
Under Voltage Lockout (UVLO)	DC-DC ON DC-DC OFF hysteresis		8VDC 7VDC 1VDC	
Input Current	V _{IN} = 18VDC, V _{OUT} = 15VDC, full load			10A
Inrush Current				1A ² s
Quiescent Current	V _{IN} = 24VDC, V _{OUT} = 12VDC, no load		75mA	
Output Voltage Trimming	refer to "OUTPUT VOLTAGE TRIMMING"	3.3VDC		16.5VDC
Output Current	V _{OUT} >= 6.5VDC V _{OUT} < 6.5VDC			6A 8A
Minimum Load		0%		
Start-up Time	power up / CTRL ON/OFF		11ms	
Rise Time			7ms	
ON/OFF CTRL	DC-DC ON DC-DC OFF		Short or 0VDC < V _{CTRL} < 0.5VDC Open or 3.1VDC < V _{CTRL} < 13.2VDC	
Input Current of CTRL Pin	DC-DC OFF		1mA	
Internal Operating Frequency			300kHz	
Output Ripple and Noise	20MHz BW, 1µF ceramic capacitor and 22µF ceramic capacitor		100mVp-p	
Reflected Back Ripple Current			94mA _{p-p}	
Remote Sense ⁽³⁾	%V _{OUT} nom.	0%		5%
Maximum Capacitive Load				1200µF

Notes:

Note3: If sense function is not being used, connect Sense pin to +Vout pin

Efficiency vs. Output Current

V_{OUT}= 3.3VDC

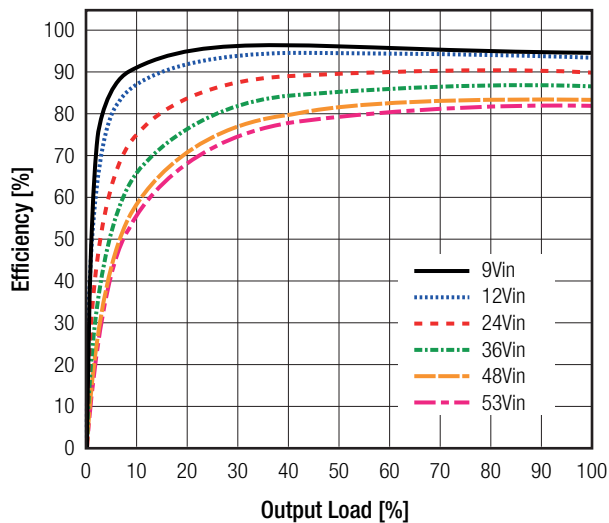

V_{OUT}= 5VDC

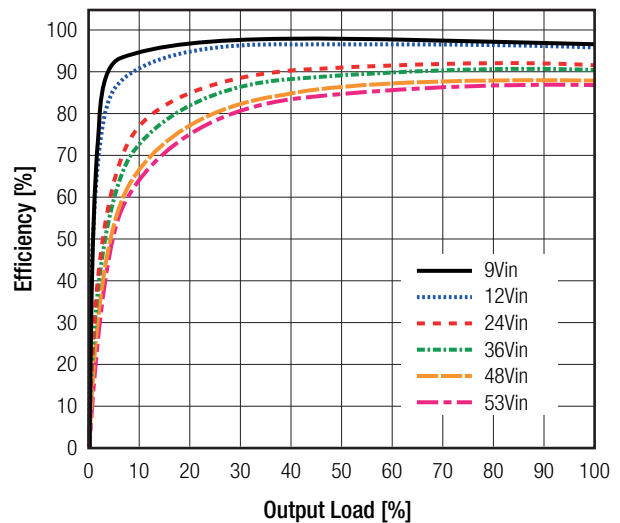

continued on next page

Specifications (measured @ Ta= 25°C, full load and after warm-up unless otherwise stated)

Efficiency vs. Output Current

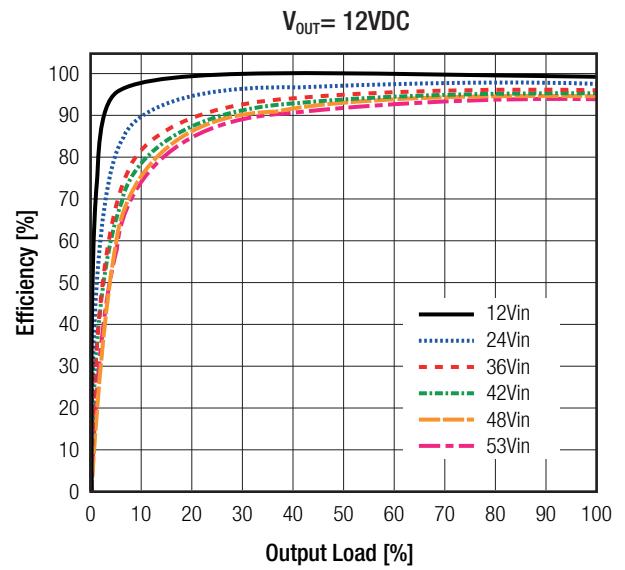
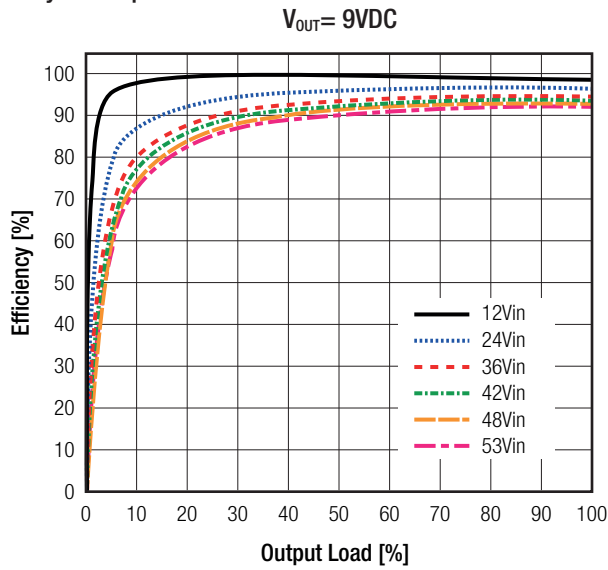

Efficiency vs. Output Current

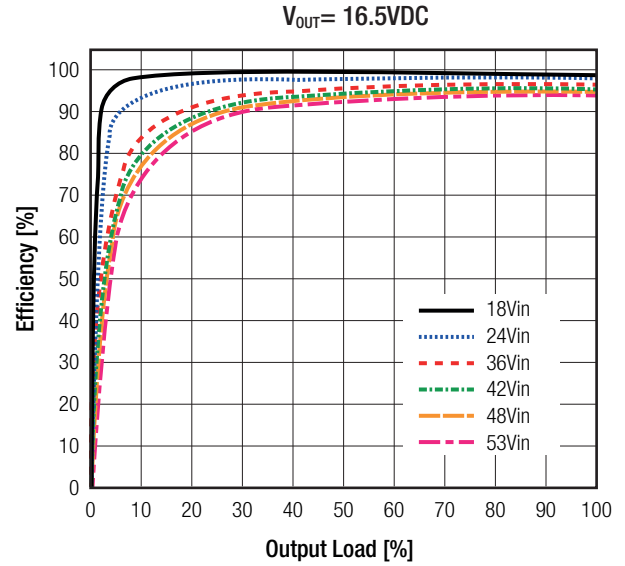
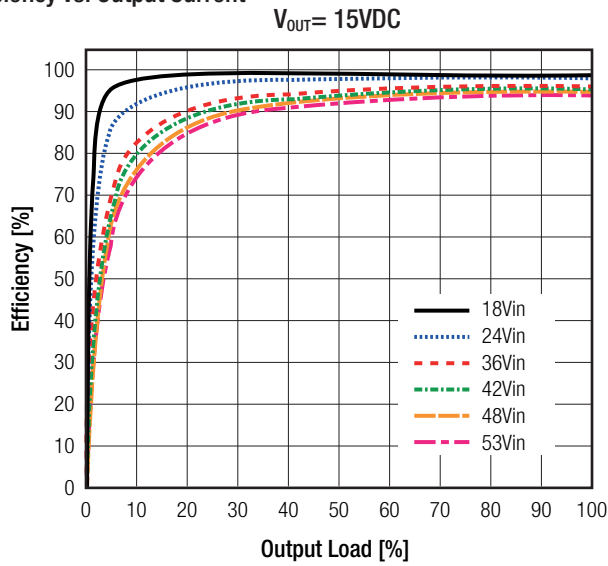

Output Voltage vs. Input Voltage

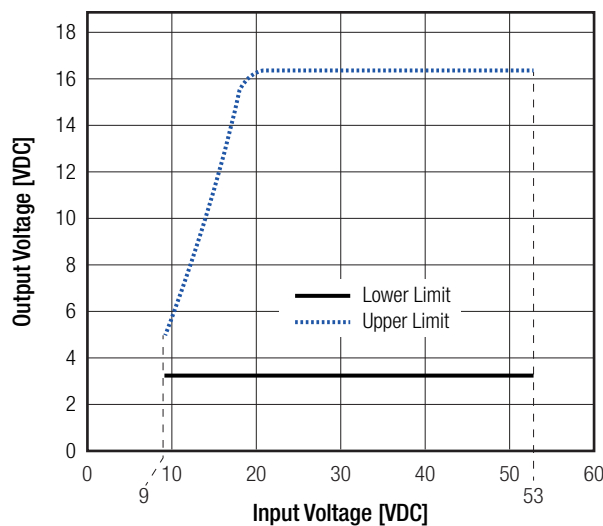

Specifications (measured @ Ta= 25°C, full load and after warm-up unless otherwise stated)

ON/OFF CTRL

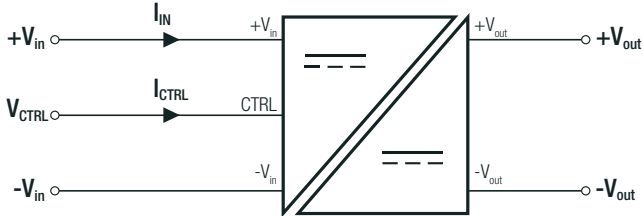

Negative Logic DC-DC ON Short or 0VDC < V_{CTRL} < 0.5VDC
DC-DC OFF Open or 3.1VDC < V_{CTRL} < 13.2VDC

OUTPUT VOLTAGE TRIMMING

The output voltage of the RPMA5.0-8.0/OF can be trimmed between 3.3VDC and 16.5VDC by using an external trim resistor. The values for the trim resistor are according to standard E96 values; therefore, the specified voltage may slightly vary. Resistor values may be calculated with the following equation:

Calculation:

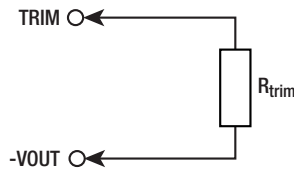

$$R_{trim} = \frac{V_{ref} \times k}{V_{OUTset} - 2.59} - 0.511 = k\Omega$$

V_{OUTnom} = nom. output voltage [VDC]
V_{OUTset} = trimmed output voltage [VDC]
V_{ref} = reference voltage [VDC]
R_{trim} = external trim resistor [kΩ]
k = trim factor [36.5]

Practical Example V_{OUTset}= 12VDC:

$$R_{trim} = \left[\frac{0.6VDC \times 36.5}{12 - 2.59} \right] - 0.511 = 1.816k\Omega$$

R_{trim} according to E96 ≈ **1k82Ω**

Practical Example V_{OUTset}= 15VDC:

$$R_{trim} = \left[\frac{0.6VDC \times 36.5}{15 - 2.59} \right] - 0.511 = 1.254k\Omega$$

R_{trim} according to E96 ≈ **1k24Ω**

V _{OUTset} =	3	5	9	12	15	[VDC]
R _{trim} E96 ≈	30k1	8k66	2k10	1k82	1k24	[Ω]

REGULATIONS

Parameter	Condition	Value
Output Accuracy	excluding trimming tolerances	±2.0% typ.
Line Regulation	low line to high line, full load	±0.2% typ.
Load Regulation	0% to 100% load	1.0% typ.
Transient Response	50% load step recovery time	360mV typ. 30μs typ.

Specifications (measured @ $T_a = 25^\circ\text{C}$, full load and after warm-up unless otherwise stated)

PROTECTIONS

Parameter	Condition	Value
Over Current Protection (OCP)		14A, hiccup mode
Over Temperature Protection (OTP)	on TC point	135°C, automatic restart

ENVIRONMENTAL

Parameter	Condition		Value
Operating Temperature Range	refer to below graphs		-40°C to +85°C
Maximum Case Temperature			+120°C
Operating Altitude			5000m
Operating Humidity	non-condensing		95% RH max.
Pollution Degree			PD2
MTBF	according to Telcordia SR332 Issue 3	80% load, $T_{AMB} = 40^\circ\text{C}$, airflow = 1.5m/s	31500 x 10 ³ hours

Derating Graph
(@ Chamber)

$V_{IN} = 24\text{VDC}$, $V_{OUT} = 5\text{VDC}$

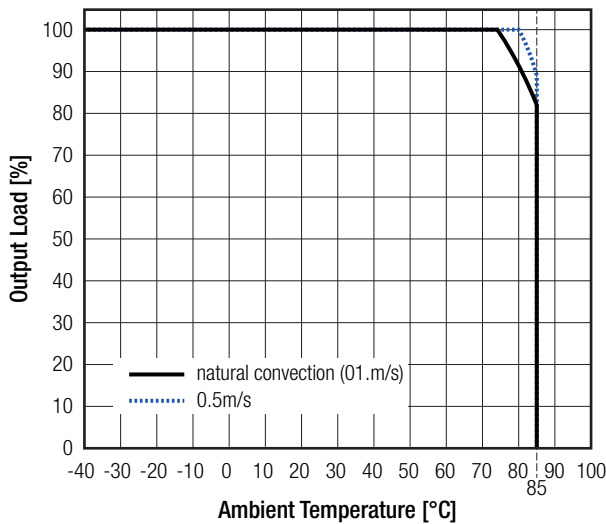

$V_{IN} = 24\text{VDC}$, $V_{OUT} = 12\text{VDC}$

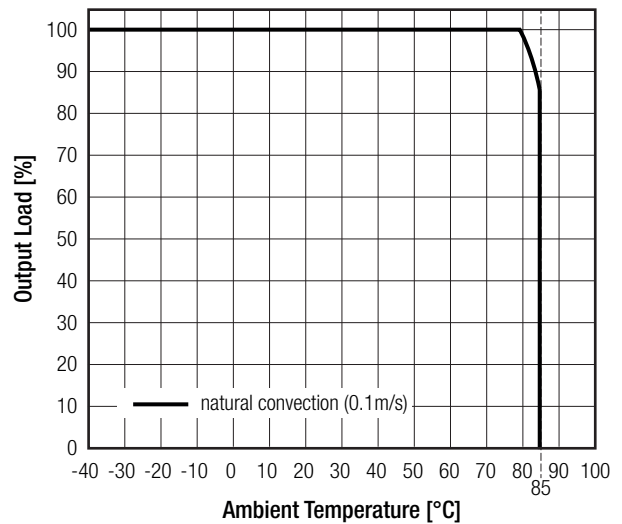

$V_{IN} = 36\text{VDC}$, $V_{OUT} = 5\text{VDC}$

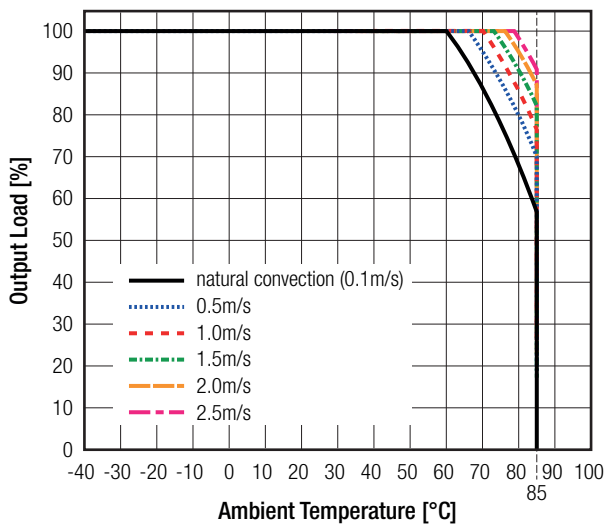

$V_{IN} = 36\text{VDC}$, $V_{OUT} = 12\text{VDC}$

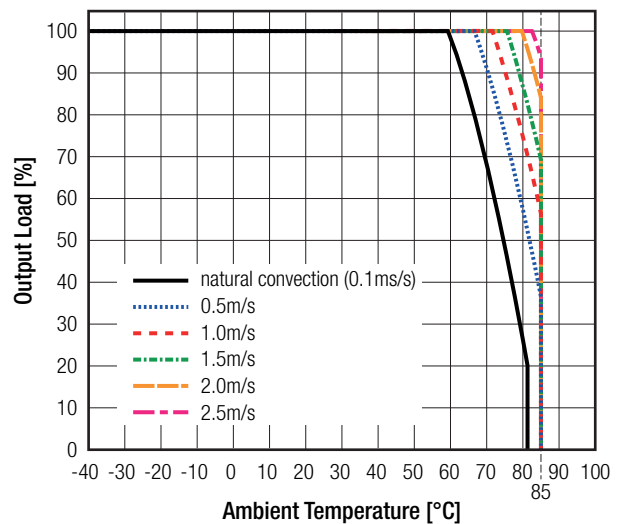

Specifications (measured @ Ta= 25°C, full load and after warm-up unless otherwise stated)

SAFETY AND CERTIFICATIONS

Certificate Type (Safety)	Report / File Number	Standard
Audio/Video, information and communication technology equipment - Part1: Safety requirements		UL62368-1:2014 CAN/CSA-C22.2 No. 62368-1:2014
RoHS2		RoHS 2011/65/EU + AM2015/863

DIMENSION AND PHYSICAL CHARACTERISTICS

Parameter	Type	Value
Material	PCB	FR4, (UL94V-0)
Dimension (LxWxH)		19.1 x 23.4 x 9.6mm
Weight		8g typ.

Dimension Drawing (mm)

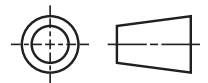
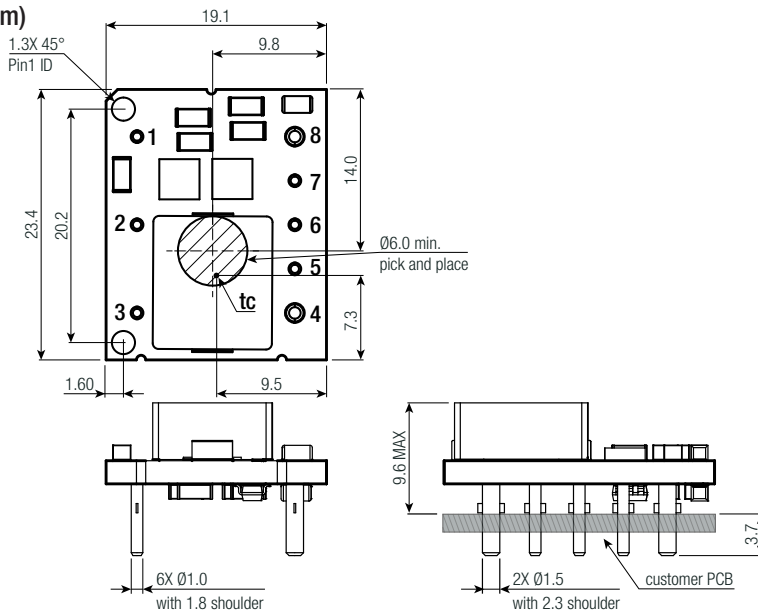

Pinning Information

Pin #	Function
1	+Vin
2	CTRL
3	-Vin
4	-Vout
5	NC
6	Trim
7	+Sense ⁽³⁾
8	+Vout

Tolerance:
xx.x = ±0.5mm
xx.xx = ±0.25mm

Recommended Footprint Details

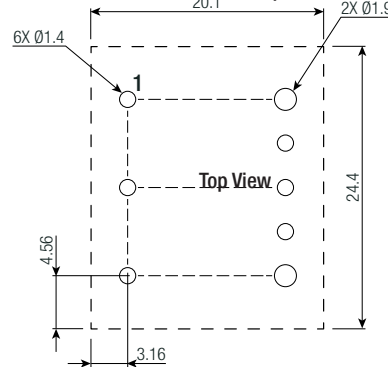

PACKAGING INFORMATION

Parameter	Type	Value
Packaging Dimension (LxWxH)	cardboard box	221.0 x 128.0 x 33.0mm
Packaging Quantity		20pcs
Storage Temperature Range		-55°C to +125°C
Storage Humidity	non-condensing	95% RH max.

The product information and specifications may be subject to changes even without prior written notice. The product has been designed for various applications; its suitability lies in the responsibility of each customer. The products are not authorized for use in safety-critical applications without RECOM's explicit written consent. A safety-critical application is an application where a failure may reasonably be expected to endanger or cause loss of life, inflict bodily harm or damage property. The applicant shall indemnify and hold harmless RECOM, its affiliated companies and its representatives against any damage claims in connection with the unauthorized use of RECOM products in such safety-critical applications.