

EasyPACK™ module with EDT2 IGBT and diode and PressFIT / NTC

Features

- Electrical features
 - Blocking voltage 750 V
 - Low $V_{CE,sat}$
 - Low switching losses
 - Low Q_g and C_{rss}
 - Low inductive design
 - $T_{vj,op} = 150^\circ\text{C}$
- Mechanical features
 - 4.2 kV DC 1 second insulation
 - High creepage and clearance distances
 - High power density
 - Integrated NTC temperature sensor
 - PressFIT contact technology
 - RoHS compliant
 - UL 94 V0 module frame



Potential applications

- Automotive applications
- (Hybrid) electrical vehicles (H)EV
- Motor drives

Product validation

- Qualified according to AQG 324

Description

The FF300R08W2P2_B11A is a very compact and flexible product offering integrated isolation for the main inverter of hybrid and electric vehicles. The module uses the benchmark EDT2 IGBT generation allowing 750V blocking voltage and I_{cN} of 300A. The chipset has benchmark current density combined with short circuit ruggedness for reliable inverter operation under harsh environmental conditions. The EDT2 IGBTs also show excellent light load power losses, which helps to improve system efficiency over a real driving cycle. The EDT2 IGBT was optimized for applications with switching frequencies in the range of 10 kHz. The EasyPACK™ package is qualified for automotive applications and is validated according to AQG 324. Its high power cycling capability as well as the high creepage and clearance distances add to the product reliability.

The power module comes with PressFIT Pins for the signal terminals to avoid additional time consuming selective solder processes, which provides cost savings on system level and increases system reliability.

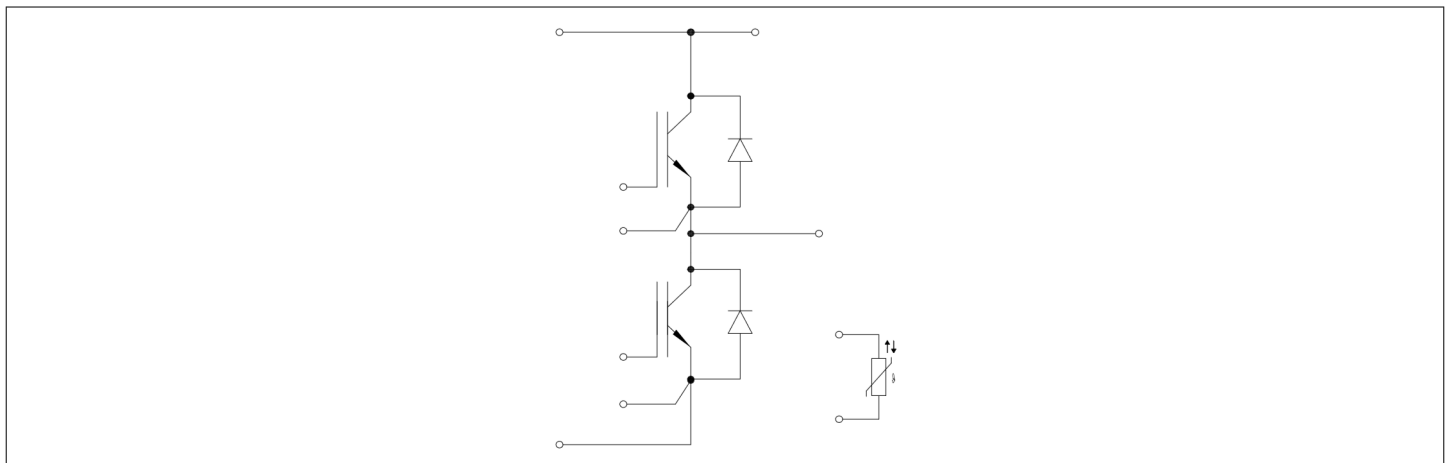

Type	Package	Marking
FF300R08W2P2_B11A	EasyPACK™ 2B Module	SP005424885

Table of contents

	Description	1
	Features	1
	Potential applications	1
	Product validation	1
	Table of contents	2
1	Package	3
2	IGBT, Inverter	3
3	Diode, Inverter	5
4	NTC-Thermistor	6
5	Characteristics diagrams	7
6	Circuit diagram	10
7	Package outlines	11
8	Module label code	12
	Revision history	13
	Disclaimer	14

1 Package

1 Package

Table 1 Maximum rated values

Parameter	Symbol	Note or test condition	Values	Unit
Maximum RMS module DC-terminal current ¹⁾	$I_{t,rms}$	$T_{terminal} = 105\text{ °C}$, $T_c = 65\text{ °C}$	25	A

1) I_{tRMS} : Current per pin, continuous, steady state. Verified by characterization / design not by test

Table 2 Insulation coordination

Parameter	Symbol	Note or test condition	Values	Unit
Isolation test voltage	V_{ISOL}		4.2	kV
Internal isolation		basic insulation (class 1, IEC 61140)	Al_2O_3	
Creepage distance	d_{creep}	terminal to heatsink	11.5	mm
Creepage distance	d_{creep}	terminal to terminal	6.3	mm
Clearance	d_{clear}	terminal to heatsink	10.0	mm
Clearance	d_{clear}	terminal to terminal	5.0	mm
Comparative tracking index	CTI		> 200	

Table 3 Characteristic values

Parameter	Symbol	Note or test condition	Values			Unit
			Min.	Typ.	Max.	
Stray inductance module	$L_{s,CE}$			8.0		nH
Module lead resistance, terminals - chip	$R_{CC'+EE'}$	$T = 25\text{ °C}$, per switch		4.00		mΩ
Storage temperature	T_{stg}		-40		125	°C
Weight	G			41		g

2 IGBT, Inverter

Table 4 Maximum rated values

Parameter	Symbol	Note or test condition	Values	Unit
Collector-emitter voltage	V_{CES}	$T_{vj} = 25\text{ °C}$	750	V
Implemented collector current	I_{CN}		300	A
Continuous DC collector current	$I_{C,nom}$	$T_{vj,max} = 150\text{ °C}$ $T_h = 65\text{ °C}$	200	A
Repetitive peak collector current	I_{CRM}	$t_p = 1\text{ ms}$	600	A
Gate-emitter peak voltage	V_{GES}		±20	V

Table 5 Characteristic values

Parameter	Symbol	Note or test condition	Values			Unit	
			Min.	Typ.	Max.		
Collector-emitter saturation voltage	$V_{CE,sat}$	$I_C = 200\text{ A}, V_{GE} = 15\text{ V}$	$T_{vj} = 25\text{ °C}$	1.00	1.18	V	
			$T_{vj} = 125\text{ °C}$	0.99			
			$T_{vj} = 150\text{ °C}$	0.98			
Gate threshold voltage	$V_{GE,th}$	$I_C = 6.4\text{ mA}, V_{CE} = V_{GE}$	$T_{vj} = 25\text{ °C}$	4.9	5.8	6.5	V
Gate charge	Q_G	$V_{GE} = 15\text{ V}, V_{CE} = 400\text{ V}$			2.9		μC
Internal gate resistor	$R_{G,int}$		$T_{vj} = 25\text{ °C}$		1.1		Ω
Input capacitance	C_{ies}	$f = 1\text{ MHz}, V_{CE} = 50\text{ V}, V_{GE} = 0\text{ V}$	$T_{vj} = 25\text{ °C}$		53.0		nF
Output capacitance	C_{oes}	$f = 1\text{ MHz}, V_{CE} = 50\text{ V}, V_{GE} = 0\text{ V}$	$T_{vj} = 25\text{ °C}$		0.7		nF
Reverse transfer capacitance	C_{res}	$f = 1\text{ MHz}, V_{CE} = 50\text{ V}, V_{GE} = 0\text{ V}$	$T_{vj} = 25\text{ °C}$		0.20		nF
Collector-emitter cut-off current	I_{CES}	$V_{CE} = 750\text{ V}, V_{GE} = 0\text{ V}$	$T_{vj} = 25\text{ °C}$			1.0	mA
Gate-emitter leakage current	I_{GES}	$V_{GE} = 0\text{ V}$	$T_{vj} = 25\text{ °C}$			10	nA
Turn-on delay time, inductive load	$t_{d,on}$	$I_C = 200\text{ A}, V_{CE} = 400\text{ V}, V_{GE} = 15\text{ V}, R_{G,on} = 2.4\text{ }\Omega$	$T_{vj} = 25\text{ °C}$		0.21		μs
			$T_{vj} = 125\text{ °C}$		0.23		
			$T_{vj} = 150\text{ °C}$		0.24		
Rise time, inductive load	t_r	$I_C = 200\text{ A}, V_{CE} = 400\text{ V}, V_{GE} = 15\text{ V}, R_{G,on} = 2.4\text{ }\Omega$	$T_{vj} = 25\text{ °C}$		0.03		μs
			$T_{vj} = 125\text{ °C}$		0.04		
			$T_{vj} = 150\text{ °C}$		0.04		
Turn-off delay time, inductive load	$t_{d,off}$	$I_C = 200\text{ A}, V_{CE} = 400\text{ V}, V_{GE} = 15\text{ V}, R_{G,off} = 5.1\text{ }\Omega$	$T_{vj} = 25\text{ °C}$		0.70		μs
			$T_{vj} = 125\text{ °C}$		0.80		
			$T_{vj} = 150\text{ °C}$		0.80		
Fall time, inductive load	t_f	$I_C = 200\text{ A}, V_{CE} = 400\text{ V}, V_{GE} = 15\text{ V}, R_{G,off} = 5.1\text{ }\Omega$	$T_{vj} = 25\text{ °C}$		0.06		μs
			$T_{vj} = 125\text{ °C}$		0.10		
			$T_{vj} = 150\text{ °C}$		0.10		
Turn-on energy loss per pulse	E_{on}	$I_C = 200\text{ A}, V_{CE} = 400\text{ V}, L_\sigma = 20\text{ nH}, V_{GE} = 15\text{ V}, R_{G,on} = 2.4\text{ }\Omega$	$T_{vj} = 25\text{ °C}$		4.4		mJ
			$T_{vj} = 125\text{ °C}$		7.0		
			$T_{vj} = 150\text{ °C}, di/dt = 6360\text{ A}/\mu\text{s}$		7.6		
Turn-off energy loss per pulse	E_{off}	$I_C = 200\text{ A}, V_{CE} = 400\text{ V}, L_\sigma = 20\text{ nH}, V_{GE} = 15\text{ V}, R_{G,off} = 5.1\text{ }\Omega$	$T_{vj} = 25\text{ °C}$		7.3		mJ
			$T_{vj} = 125\text{ °C}$		10.7		
			$T_{vj} = 150\text{ °C}, du/dt = 2530\text{ V}/\mu\text{s}$		11.5		

Table 5 Characteristic values (continued)

Parameter	Symbol	Note or test condition	Values			Unit	
			Min.	Typ.	Max.		
SC data	I_{SC}	$V_{CC} = 400 \text{ V}, V_{GE} = 15 \text{ V}$	$t_p \leq 6.0 \mu\text{s}, T_{vj} = 25 \text{ }^\circ\text{C}$		3800		A
			$t_p \leq 4.0 \mu\text{s}, T_{vj} = 150 \text{ }^\circ\text{C}$		3000		
Thermal resistance, junction to case	$R_{th,j-c}$	per IGBT		0.09		K/W	
Thermal resistance, junction to heatsink	$R_{th,j-h}$	per IGBT, $\lambda_{paste} = 3 \text{ W}/(\text{m}^2\text{K}) / \lambda_{grease} = 3 \text{ W}/(\text{m}^2\text{K})$		0.25		K/W	
Temperature under switching conditions	$T_{vj,op}$		-40		150	$^\circ\text{C}$	

3 Diode, Inverter

Table 6 Maximum rated values

Parameter	Symbol	Note or test condition	Values	Unit	
Repetitive peak reverse voltage	V_{RRM}	$T_{vj} = 25 \text{ }^\circ\text{C}$	750	V	
Implemented forward current	I_{FN}		300	A	
Continuous DC forward current	$I_{F,nom}$		200	A	
Repetitive peak forward current	I_{FRM}	$t_p = 1 \text{ ms}$	600	A	
I^2t - value	I^2t	$V_R = 400 \text{ V}, t_p = 50 \text{ ms}$	$T_{vj} = 125 \text{ }^\circ\text{C}$	15770	A^2s
			$T_{vj} = 150 \text{ }^\circ\text{C}$	13180	

Table 7 Characteristic values

Parameter	Symbol	Note or test condition	Values			Unit	
			Min.	Typ.	Max.		
Forward voltage	V_F	$I_F = 200 \text{ A}$	$T_{vj} = 25 \text{ }^\circ\text{C}$		1.30	1.47	V
			$T_{vj} = 125 \text{ }^\circ\text{C}$		1.20		
			$T_{vj} = 150 \text{ }^\circ\text{C}$		1.15		
Peak reverse recovery current	I_{rm}	$I_F = 200 \text{ A}, V_{CE} = 400 \text{ V}, V_{GE} = -8 \text{ V}$	$T_{vj} = 25 \text{ }^\circ\text{C}$		200		A
			$T_{vj} = 125 \text{ }^\circ\text{C}$		294		
			$T_{vj} = 150 \text{ }^\circ\text{C}, -di_F/dt = 7250 \text{ A}/\mu\text{s}$		321		

Table 7 Characteristic values (continued)

Parameter	Symbol	Note or test condition	Values			Unit
			Min.	Typ.	Max.	
Recovered charge	Q_r	$I_F = 200\text{ A}, V_{CE} = 400\text{ V}, V_{GE} = -8\text{ V}$	$T_{vj} = 25\text{ °C}$	11.0		μC
			$T_{vj} = 125\text{ °C}$	24.0		
			$T_{vj} = 150\text{ °C}, -di_F/dt = 7250\text{ A}/\mu\text{s}$	29.0		
Reverse recovery energy	E_{rec}	$I_F = 200\text{ A}, V_{CE} = 400\text{ V}, V_{GE} = -8\text{ V}, R_G = 2.4\ \Omega$	$T_{vj} = 25\text{ °C}$	3.34		mJ
			$T_{vj} = 125\text{ °C}$	7.02		
			$T_{vj} = 150\text{ °C}, -di_F/dt = 7250\text{ A}/\mu\text{s}$	8.51		
Thermal resistance, junction to case	$R_{th,j-c}$	per diode		0.17		K/W
Thermal resistance, junction to heatsink	$R_{th,j-h}$	per diode, $\lambda_{paste} = 3\text{ W}/(\text{m}^*\text{K}) / \lambda_{grease} = 3\text{ W}/(\text{m}^*\text{K})$		0.36		K/W
Temperature under switching conditions	$T_{vj,op}$		-40		150	°C

4 NTC-Thermistor

Table 8 Characteristic values

Parameter	Symbol	Note or test condition	Values			Unit
			Min.	Typ.	Max.	
Rated resistance	R_{25}	$T_{NTC} = 25\text{ °C}$		5		k Ω
Deviation of R_{100}	$\Delta R/R$	$T_{NTC} = 100\text{ °C}, R_{100} = 493\ \Omega$	-5		5	%
Power dissipation	P_{25}	$T_{NTC} = 25\text{ °C}$			20	mW
B-value	$B_{25/50}$	$R_2 = R_{25} \exp[B_{25/50}(1/T_2 - 1/(298,15\text{ K}))]$		3375		K
B-value	$B_{25/80}$	$R_2 = R_{25} \exp[B_{25/80}(1/T_2 - 1/(298,15\text{ K}))]$		3433		K
B-value	$B_{25/100}$	$R_2 = R_{25} \exp[B_{25/100}(1/T_2 - 1/(298,15\text{ K}))]$		3411		K

5 Characteristics diagrams

output characteristic (typical), IGBT, Inverter

$I_C = f(V_{CE})$
 $V_{GE} = -8\text{ V} / +15\text{ V}$

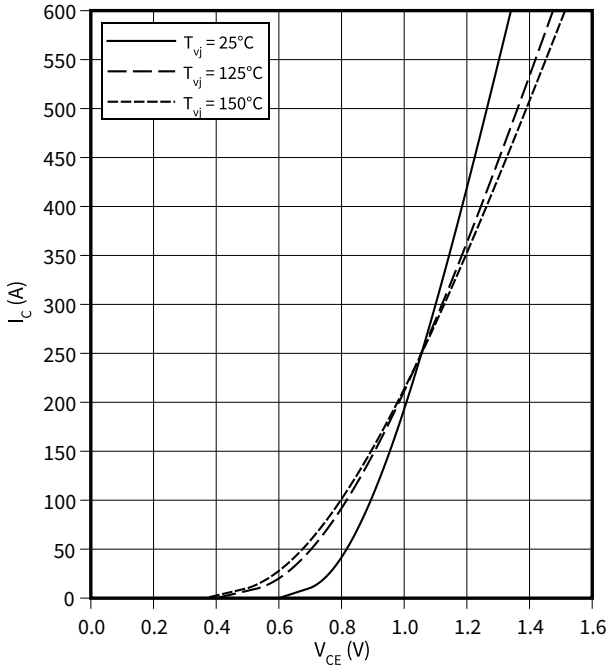

output characteristic (typical), IGBT, Inverter

$I_C = f(V_{CE})$
 $T_{vj} = 25^\circ\text{C}$

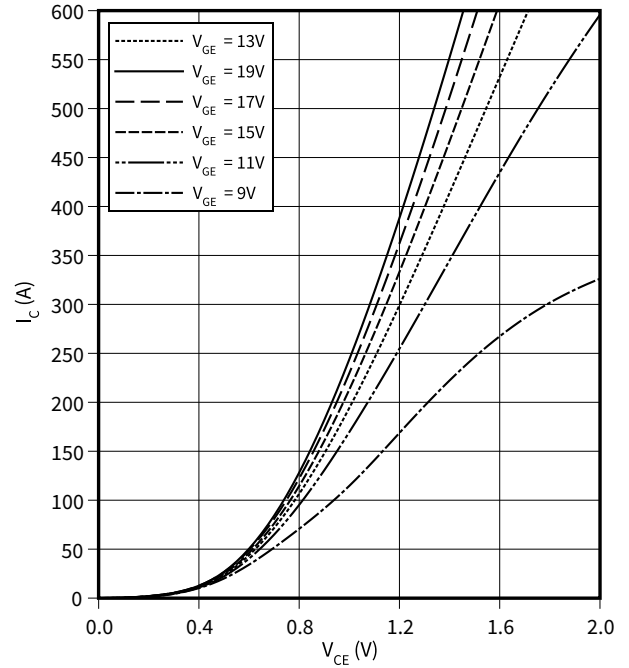

transfer characteristic (typical), IGBT, Inverter

$I_C = f(V_{GE})$
 $V_{CE} = 20\text{ V}$

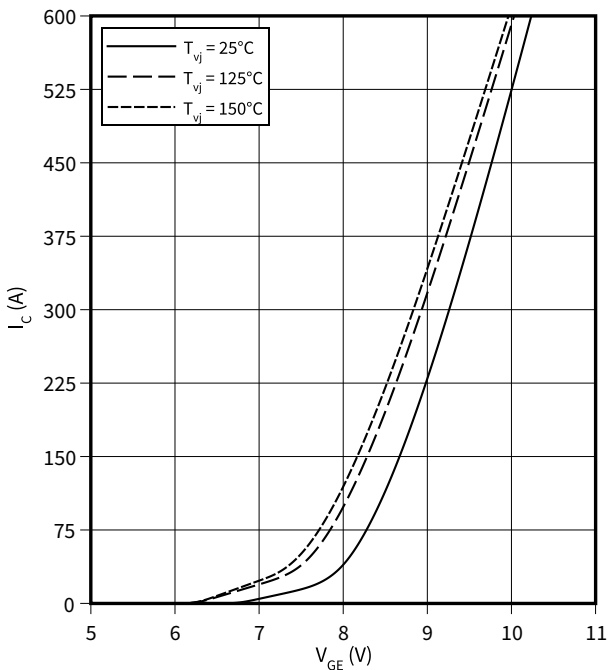

switching losses (typical), IGBT, Inverter

$E = f(I_C)$
 $R_{G,off} = 5.1\ \Omega$, $R_{G,on} = 2.4\ \Omega$, $V_{CE} = 400\text{ V}$, $V_{GE} = -8\text{ V} / +15\text{ V}$

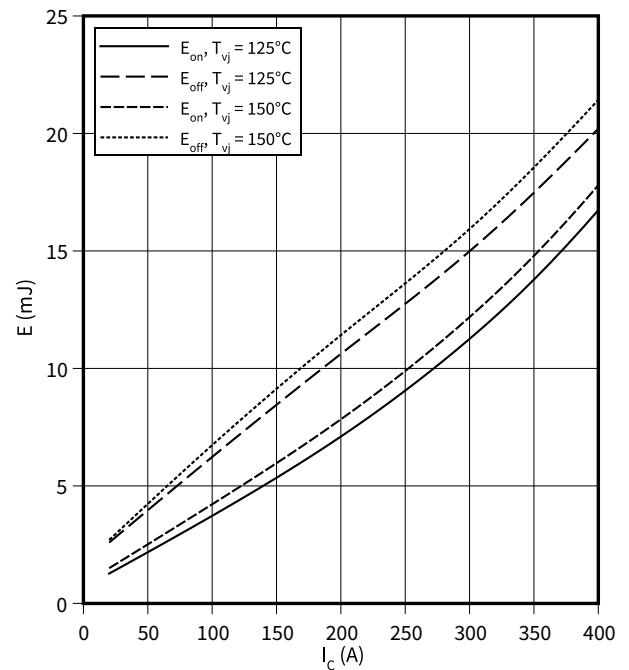

5 Characteristics diagrams

Switching losses (typical), IGBT, Inverter

$E = f(R_G)$

$V_{CE} = 400\text{ V}, V_{GE} = -8\text{ V} / +15\text{ V}, I_C = 200\text{ A}$

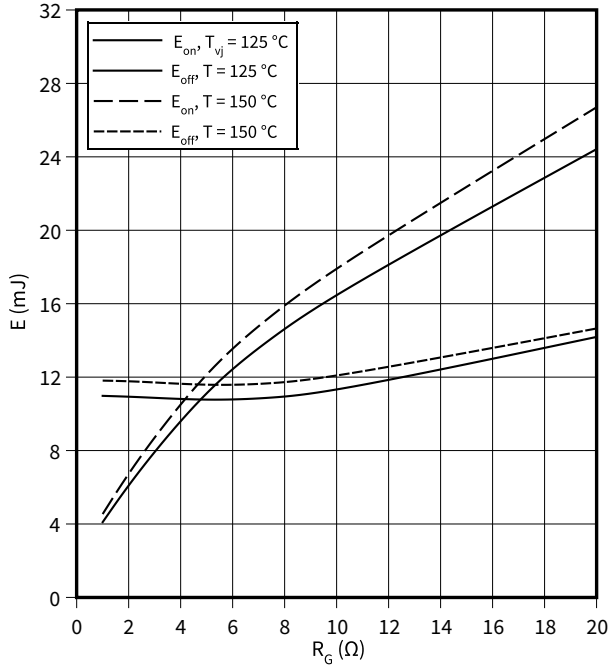

transient thermal impedance, IGBT, Inverter

$Z_{th} = f(t)$

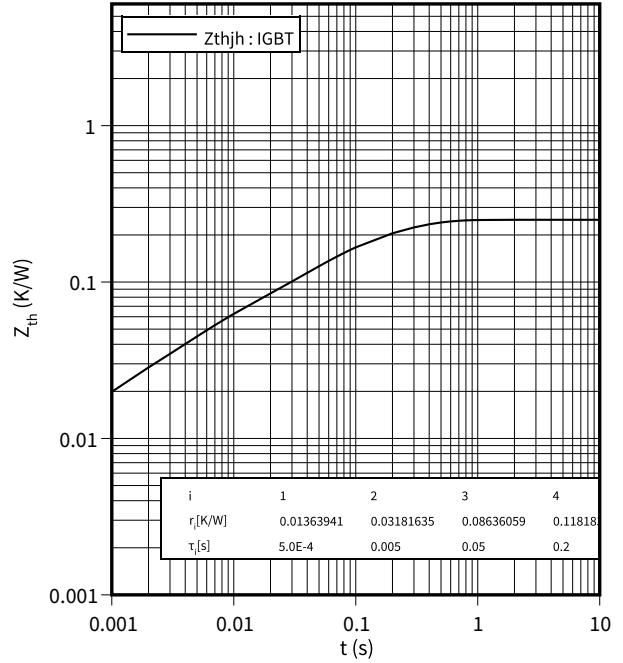

Reverse bias safe operating area (RBSOA), IGBT, Inverter

$I_C = f(V_{CE})$

$T_{vj} = 150\text{ °C}, R_{G,off} = 5.1\text{ Ω}, V_{GE} = -8\text{ V} / +15\text{ V}$

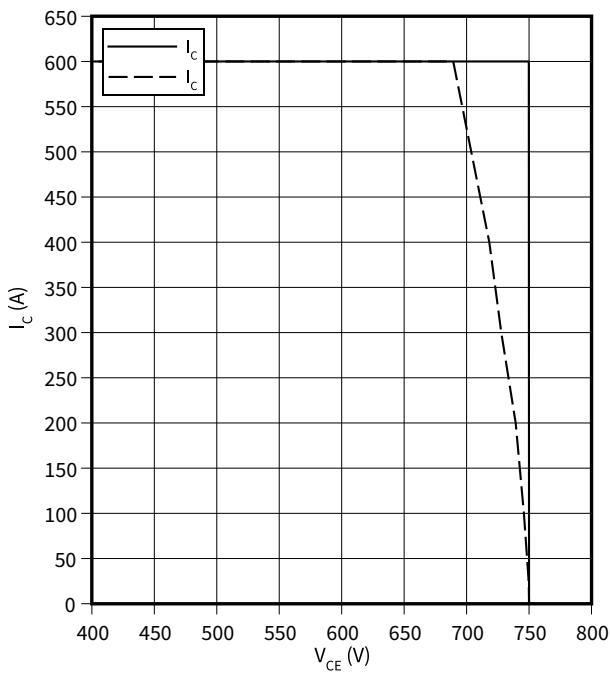

forward characteristic of (typical), Diode, Inverter

$I_F = f(V_F)$

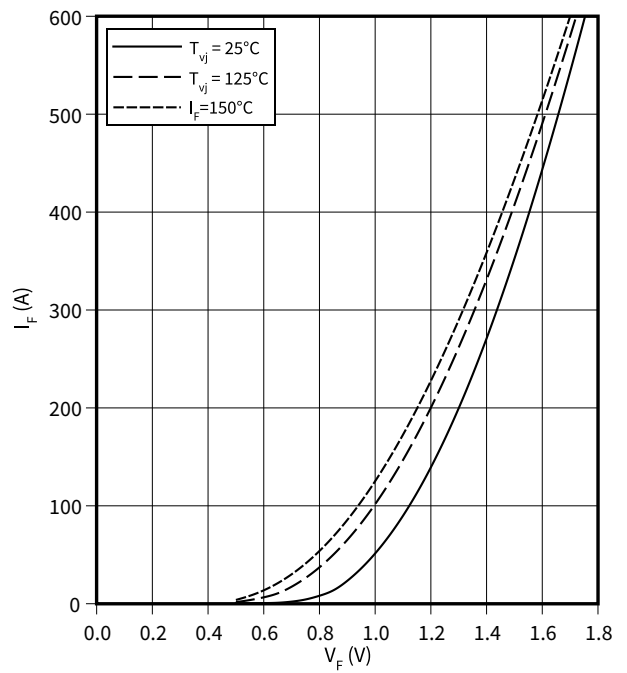

5 Characteristics diagrams

switching losses (typical), Diode, Inverter

$E_{rec} = f(I_F)$

$R_{Gon} = R_{Gon}(IGBT), V_{CE} = 400 V$

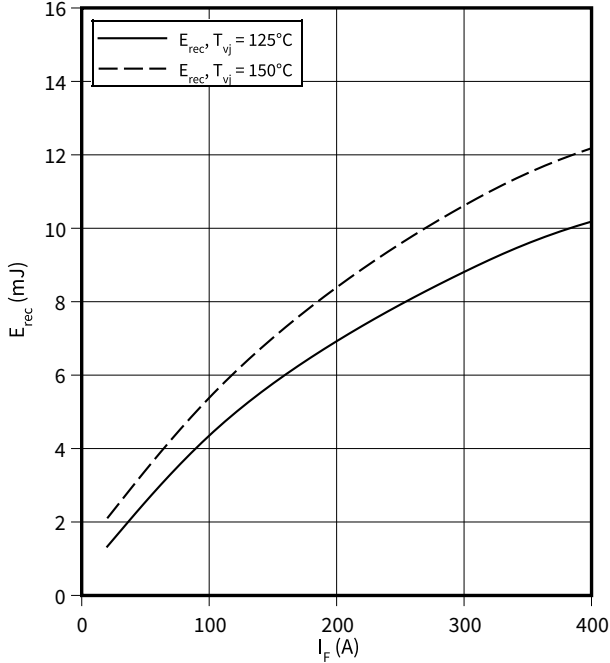

Switching losses (typical), Diode, Inverter

$E_{rec} = f(R_G)$

$V_{CE} = 400 V, I_F = 200 A$

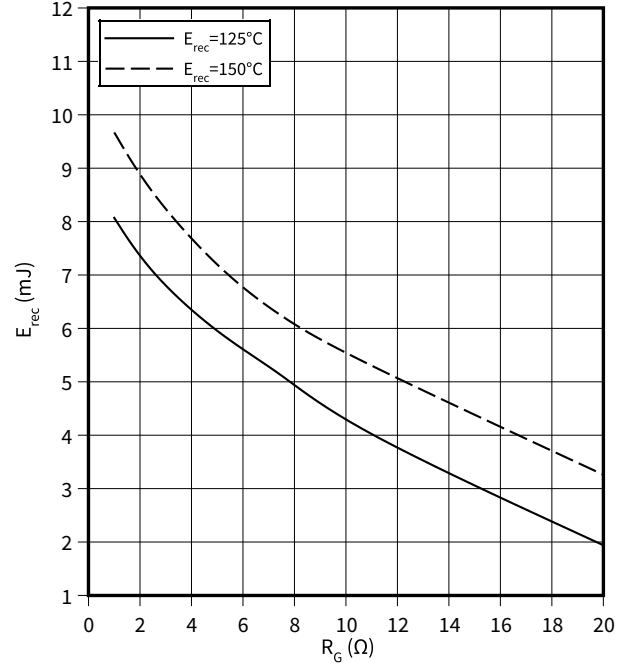

transient thermal impedance , Diode, Inverter

$Z_{th} = f(t)$

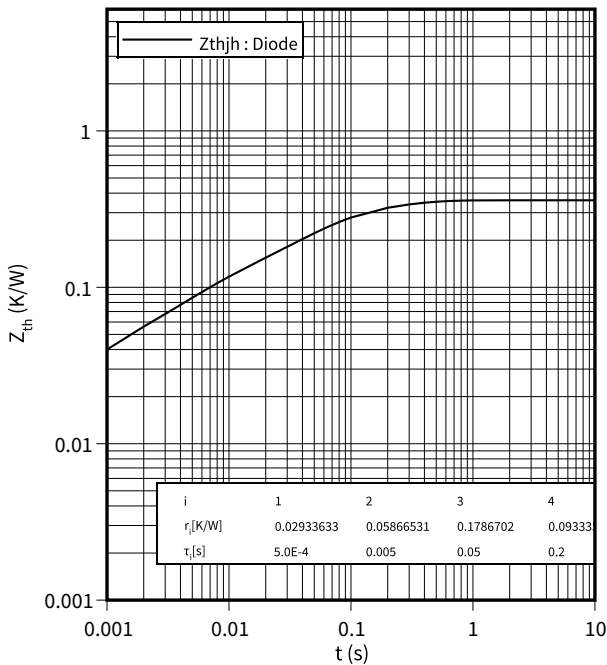

temperature characteristic (typical), NTC-Thermistor

$R = f(T_{NTC})$

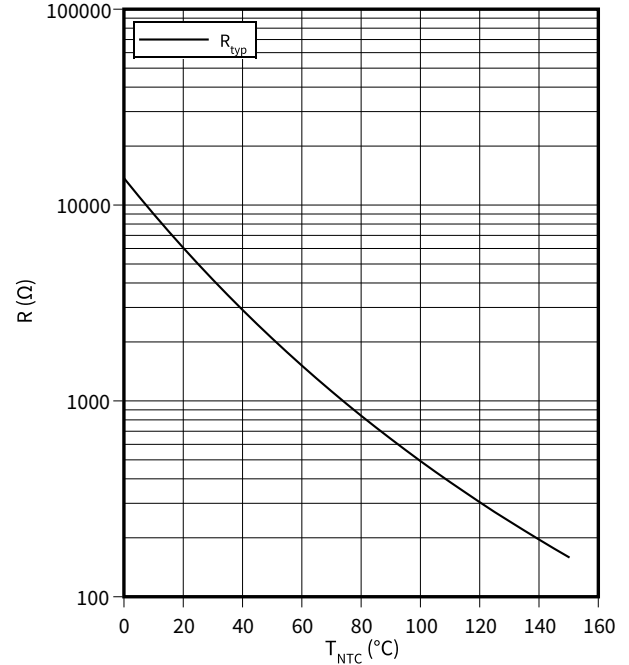

6 Circuit diagram

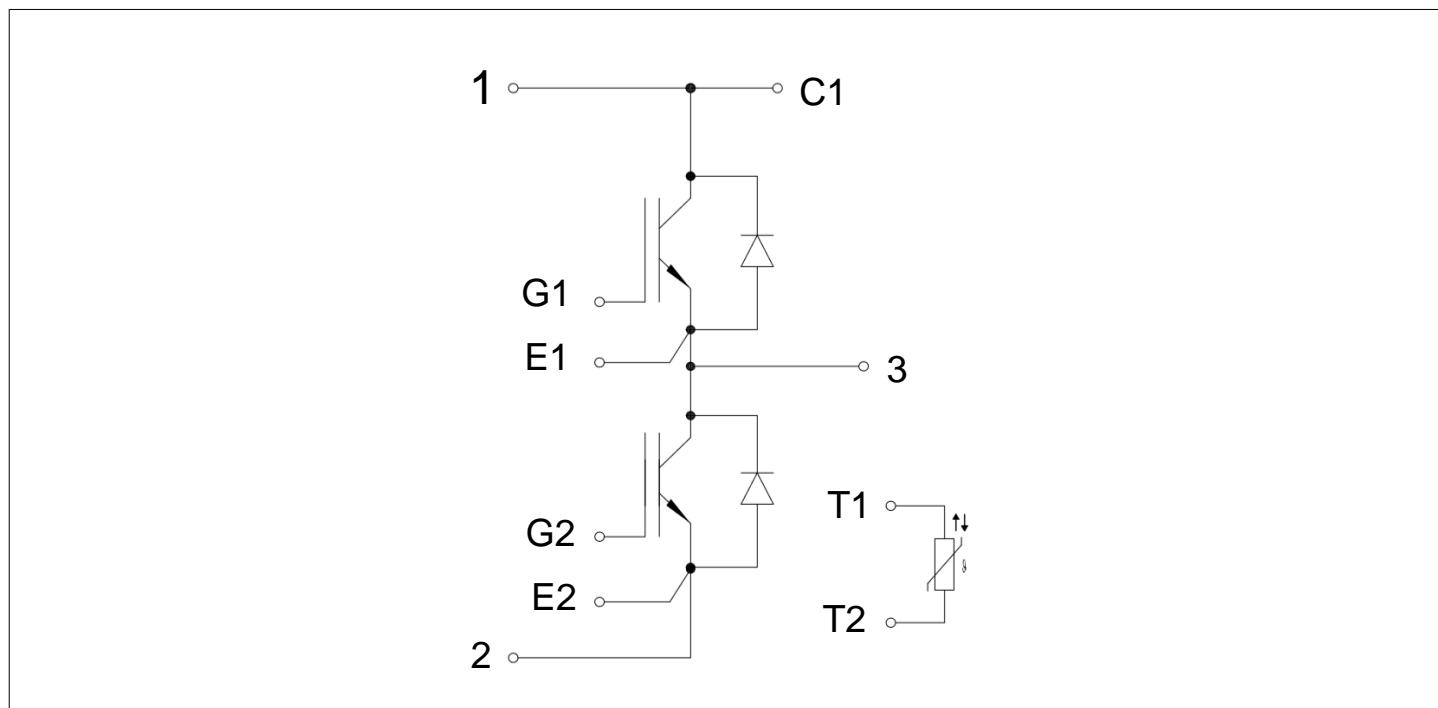

Figure 2

7 Package outlines

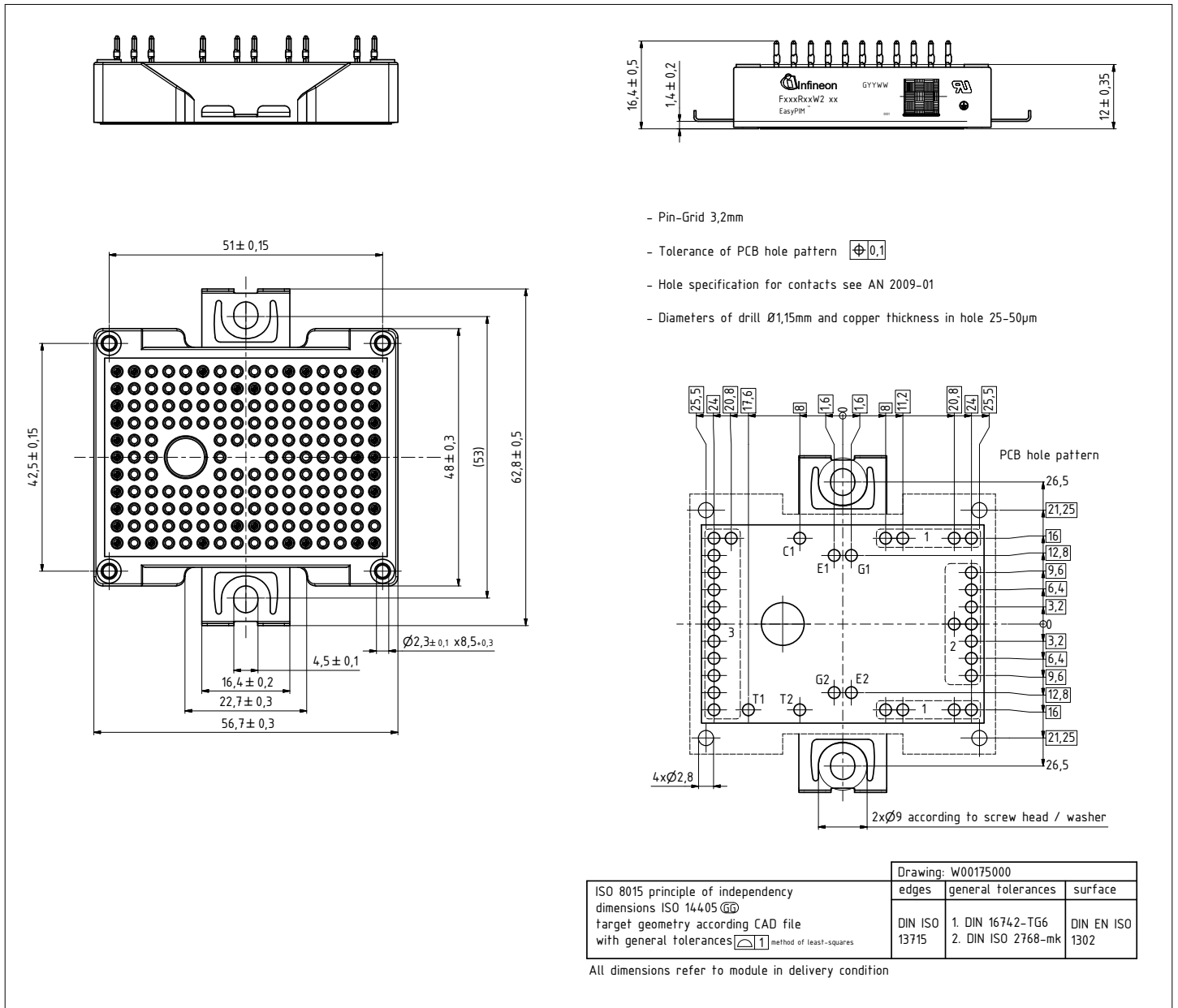

Figure 3

8 Module label code

Module label code				
Code format	Data Matrix	Barcode Code128		
Encoding	ASCII text	Code Set A		
Symbol size	16x16	23 digits		
Standard	IEC24720 and IEC16022	IEC8859-1		
Code content	<i>Content</i>	<i>Digit</i>	<i>Example</i>	
	Module serial number	1 - 5	71549	
	Module material number	6 - 11	142846	
	Production order number	12 - 19	55054991	
	Date code (production year)	20 - 21	15	
	Date code (production week)	22 - 23	30	
Example	 71549142846550549911530		 71549142846550549911530	
Packing label code				
Code format	Barcode Code128			
Encoding	Code Set A			
Symbol size	34 digits			
Standard	IEC8859-1			
Code content	<i>Content</i>	<i>Identifier</i>	<i>Digit</i>	<i>Example</i>
	Module serial number	X	2 - 9	95056609
	Module material number	1T	12 - 19	2X0003E0
	Production order number	S	21 - 25	754389
	Date code (production year)	9D	28 - 31	1139
	Date code (production week)	Q	33 - 34	15
Example	 X950566091T2X0003E0S754389D1139Q15			

Figure 4

Revision history

Revision history

Document revision	Date of release	Description of changes
V1.0	2020-07-24	Target Datasheet
1.00	2021-07-29	Final datasheet
1.01	2021-09-13	Layout correction

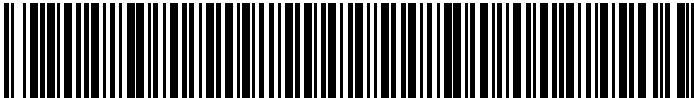
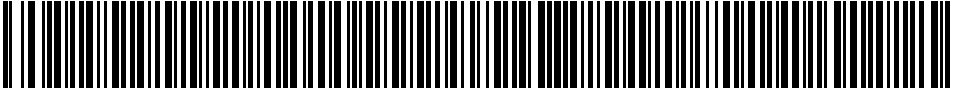
Trademarks

All referenced product or service names and trademarks are the property of their respective owners.

Edition 2021-09-13

Published by

Infineon Technologies AG

81726 Munich, Germany

© 2021 Infineon Technologies AG

All Rights Reserved.

Do you have a question about any aspect of this document?

Email: erratum@infineon.com

Document reference

IFX-AAK248-003

IMPORTANT NOTICE

The information given in this document shall in no event be regarded as a guarantee of conditions or characteristics ("Beschaffheitsgarantie").

With respect to any examples, hints or any typical values stated herein and/or any information regarding the application of the product, Infineon Technologies hereby disclaims any and all warranties and liabilities of any kind, including without limitation warranties of non-infringement of intellectual property rights of any third party.

In addition, any information given in this document is subject to customer's compliance with its obligations stated in this document and any applicable legal requirements, norms and standards concerning customer's products and any use of the product of Infineon Technologies in customer's applications.

The data contained in this document is exclusively intended for technically trained staff. It is the responsibility of customer's technical departments to evaluate the suitability of the product for the intended application and the completeness of the product information given in this document with respect to such application.

WARNINGS

Due to technical requirements products may contain dangerous substances. For information on the types in question please contact your nearest Infineon Technologies office.

Except as otherwise explicitly approved by Infineon Technologies in a written document signed by authorized representatives of Infineon Technologies, Infineon Technologies' products may not be used in any applications where a failure of the product or any consequences of the use thereof can reasonably be expected to result in personal injury.