

MD21605A6W-FPTLRGB	2 x 16	5mm Character Height	LCD Module
<b>Specification</b>			
Version: 1		Date: 13/09/2021	
<b>Revision</b>			
1	11/09/2021	First Issue	

Display Features			
Character Count		2 x 16	
Appearance		Black on RGB	
Logic Voltage		5V	
Interface		Parallel	
Font Set		English / Japanese	
Display Mode		Transflective	
Character Height		5.23mm	
LC Type		FSTN	
Module Size		84.00 x 44.00 x 13.50 mm	
Operating Temperature		-20°C ~ +70°C	
Construction		COB	Box Quantity
LED Backlight		RGB	Weight / Display



**RoHS**  
compliant

\* - For full design functionality, please use this specification in conjunction with the ST7066U + ST7065C specification. (Provided Separately)

Display Accessories	
Part Number	Description
MCCMDB-16SIL	LCD Interconnect board, can be driven from either a PC or a single Board computer with a USB output.
MCCBL1A16SLIP-16DILS-150	16 Way, Single in-line to Dual In-line connector Cable.
MCCBL1A16SLIP-16SILS-150	16 Way, Single in-line to Single In-line connector Cable.

Optional Variants		
Fonts	Appearances	Voltage
English/Euro English/Cyrillic	Black on Yellow/ Green White on Blue Black on White	3V 3.3V



## FEATURES

AVAILABLE OPTIONS	CHARACTERISTICS
DISPLAY FORMAT	16Characters by 2 Lines
POLARIZER OPTIONS	Positive Transflective
BACKLIGHT TYPE OPTIONS	Edge Type LED Backlight (Long life span version)
BACKLIGHT COLOR OPTIONS	RedGreenBlue three color
LCD PANEL OPTIONS	FSTN
VIEWING ANGLE OPTIONS	6:00 (Bottom )
TEMPERATURE RANGE OPTIONS	-20°C ~ 70°C, Single Supply Voltage
SUGGESTED DRIVING VOLTAGE	V <sub>lcm</sub> = 5.0V V <sub>led</sub> = 5.0V
SUGGESTED LED DRIVING MODE	PIN15: LED+, PIN16:K(B),PIN17:K(G),PIN18:K(R)
CONTROLLER	ST7066U+ST7065C
FONT MAP CODE	E Version
DRIVING DUTY	1/16
DRIVING BIAS	1/5

## MECHANICAL SPECIFICATIONS

<b>OVERALL SIZE</b>	84.0W x 44.0H	mm	<b>THICKNESS</b>	max 13.5	mm
<b>VIEWING AREA</b>	64.5W x 16.4H	mm	<b>HOLE-HOLE</b>	79.0/76.0W x 36.0H	mm
<b>CHARACTER SIZE</b>	3.00W x 5.23H	mm	<b>CHARACTER PITCH</b>	0.51W x 0.52H	mm
<b>DOT SIZE</b>	0.56W x 0.61H	mm	<b>DOT PITCH</b>	0.05W x 0.05H	mm

## ABSOLUTE MAXIMUM RATINGS

ITEM	SYMBOL	CONDITION	MIN	TYP	MAX	UNIT
POWER SUPPLY ( LOGIC)	V <sub>dd</sub>	25°C	-0.3	—	7.0	V
POWER SUPPLY (LCD)	V <sub>0</sub>	25°C	V <sub>dd</sub> -13.5	—	V <sub>dd</sub> +0.3	V
INPUT VOLTAGE	V <sub>in</sub>	25°C	-0.3	—	V <sub>dd</sub> +0.3	V
OPERATING TEMPERATURE	V <sub>opr</sub>	—	-20	—	70	°C
STORAGE TEMPERATURE	V <sub>stg</sub>	—	-30	—	80	°C

## ELECTRONIC CHARACTERISTICS \*

	ITEM	SYMBOL	CONDITION	MIN	TYP	MAX	UNIT
	INPUT VOLTAGE	V <sub>dd</sub>	—	—	5.0	—	V
	SUPPLY CURRENT	I <sub>dd</sub>	V <sub>dd</sub> =5V	—	1.5	—	mA
	DRIVING VOLTAGE FOR LCD PANEL	V <sub>lcd</sub> = (V <sub>dd</sub> - V <sub>0</sub> )	-20°C	4.45	—	4.90	V
			0°C	4.35	—	4.85	
			25°C	4.25	4.50	4.80	
			50°C	4.15	—	4.70	
			70°C	4.05	—	4.60	



## LCD CHARACTERISTICS

**FOR STN/FSTN TYPE LCD Panel (TA=25 °C, Vlcd=5.0V ± 0.5V)**

	ITEM	SYMBOL	CONDITION	MIN	TYP	MAX	UNIT
	VIEWING ANGLE	$\Phi 2 - \Phi 1$	K=4	40	—	—	deg
		$\theta$		60			
	CONTRAST RATIO	K	—	6	—	—	—
	RESPONSE TIME(RISE)	TR	—	—	150	250	ms
	RESPONSE TIME(FALL)	TF	—	—	150	250	ms

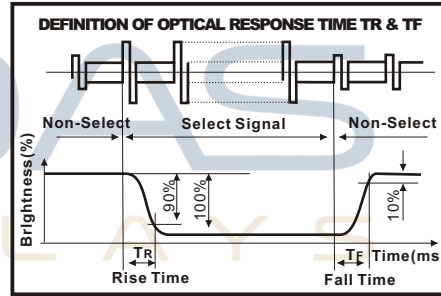
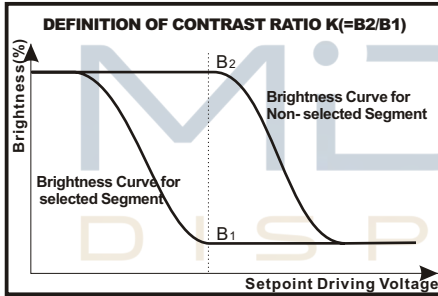
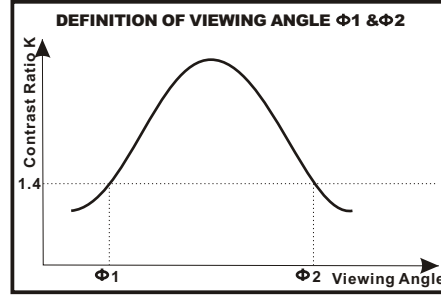
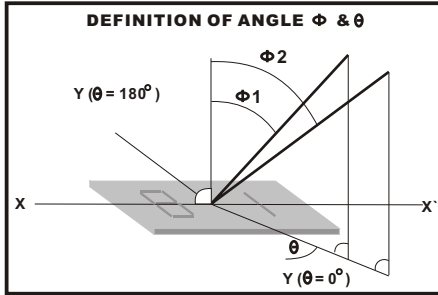

## LED CHARACTERISTICS

ITEM	SYMBOL	CONDITION	MIN			TYP			MAX			UNIT
			R	G	B	R	G	B	R	G	B	
LED FORWARD VOLTAGE	Vf	25 °C	1.8	2.9	2.9	—	—	—	2.2	3.4	3.4	V
LED FORWARD CURRENT	If	25 °C	—	—	—	—	—	—	20	20	20	mA
LED REVERSE CURRENT	Ir	25 °C	—	—	—	—	—	—	10	10	10	µA/LED
LED PEAK WAVE LENGTH	λp	25 °C	620	520	465	—	—	—	630	530	475	nm
LED BRIGHTNESS (WITHOUT LCD)	Lv	25 °C	—	—	—	30	135	35	—	—	—	cd/m <sup>2</sup>
LED BRIGHTNESS UNIFORMITY	Lvmin/Lvmax	25 °C	70			—			—			Ratio
LED LIFE TIME	—	25 °C	20K			—			—			Hours



**PIN ASSIGNMENT**

PIN	SYMBOL	DESCRIPTION	REMARKS
1	Vss	GND	
2	Vdd	Power supply for LCM	5.0V
3	V0	Contrast Adjust	
4	RS	Register Select Signal	
5	R/W	Data Read / Write	
6	E	Enable Signal	
7	DB0	Data bus line	
8	DB1	Data bus line	
9	DB2	Data bus line	
10	DB3	Data bus line	
11	DB4	Data bus line	
12	DB5	Data bus line	
13	DB6	Data bus line	
14	DB7	Data bus line	
15	LED+	Power supply for BKL	5.0V
16	K(B)	Power supply for BKL	0V
17	K(G)	Power supply for BKL	0V
18	K(R)	Power supply for BKL	0V

DISPLAYS

**BLOCK DIAGRAM**

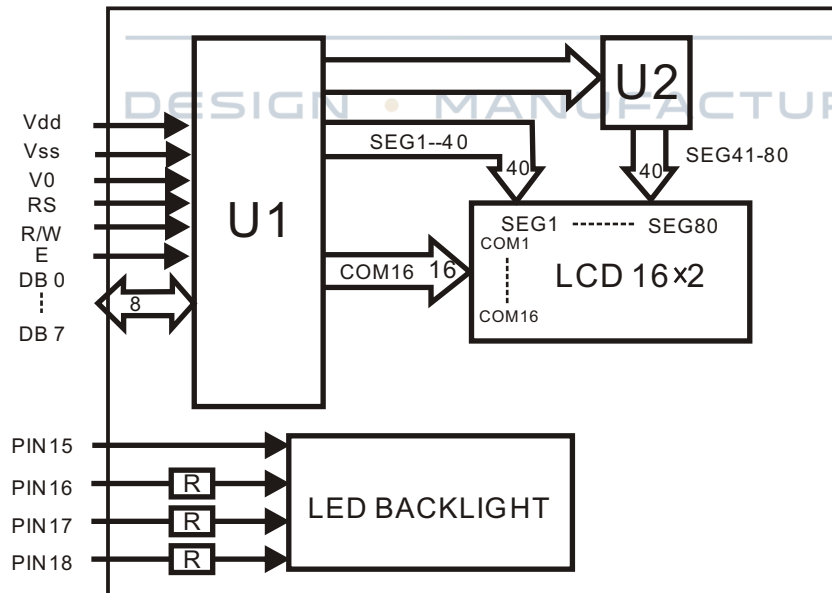

**POWER SUPPLY DIAGRAM**

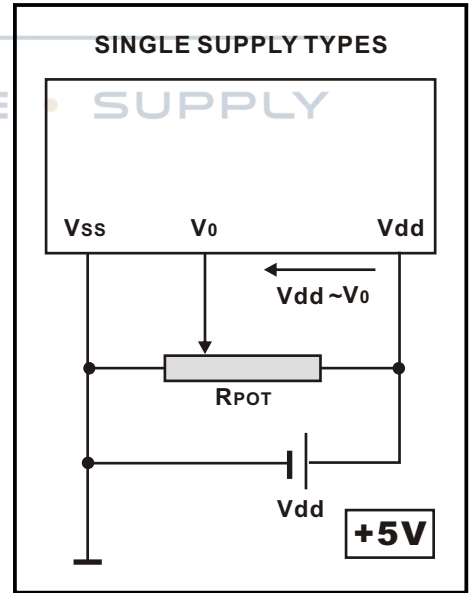

Upper 4bit Lower 4bit	LLLL	LLLH	LLHL	LLHH	LHLL	LHLH	LHHL	LHHH	HLLL	HLLH	HLHL	HLHH	HHLL	HHLH	HHHL	HHHH
LLLL	CG RAM (1)															
LLLH	(2)															
LLHL	(3)															
LLHH	(4)															
LHLL	(5)															
LHLH	(6)															
LHHL	(7)															
LHHH	(8)															
HLLL	(1)															
HLLH	(2)															
HLHL	(3)															
HLHH	(4)															
HHLL	(5)															
HHLH	(6)															
HHHL	(7)															
HHHH	(8)															



