

Power Inductor

Automotive Grade

AMRU Series



Overview

Power inductors are passive electronic components used in various circuits to store energy in a magnetic field when electrical current flows through them. They are critical in filtering, energy storage, and noise suppression in power electronic systems. They are designed to handle higher currents and are optimized for minimal power loss and thermal efficiency.

Benefits

1. Automotive grade available
2. Energy Storage, Efficiently stores and transfers energy in DC-DC converters and power supplies.
3. High Current Handling, Supports high current capacity with minimal losses, ensuring thermal stability.
4. Compact and Efficient Design, Advanced materials and construction enable miniaturization without sacrificing performance, ideal for space-constrained designs.

Applications

1. Automotive Systems for ADAS, infotainment.
2. Industrial Equipment: Robotics, power tools, industrial automation, and IoT devices.
3. DC-DC converters, inverters, and battery management systems.
4. Base stations, 5G infrastructure, and signal processing systems.
5. Consumer Electronics: Smartphones, laptops, tablets, wearable devices, and gaming consoles.

Product Information

Series	L (mm)	W(mm)	T (mm)	Inductance (μH)
AMRU	4.2	4.7	1.2	0.22 ~ 47
	4.2	4.7	1.8	
	6.8	7.3	2.8	
	10.2	11.6	3.8	
	12.8	13.8	6.5	



AMRU00040420 Series Specification

AEC-Q200

1 Scope This specification applies to large current and low loss SMD power inductor.

2 Part numbering

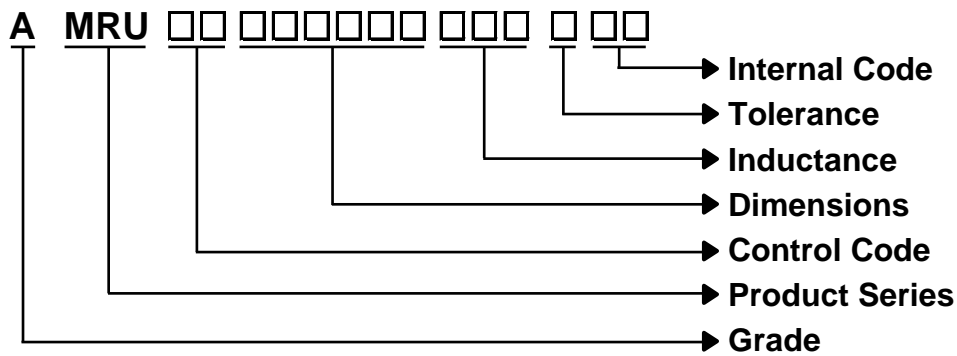

3 Temperature rating

Operating Temperature: - 40°C to 125°C.

Storage Temperature: (on tape & reel): -20°C to +40°C; 75% RH max.

4 Marking

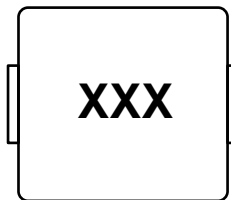

Marking: 1R0

5 Standard testing condition

	Unless otherwise specified	In case of doubt
Temperature	Ordinary Temperature(15 to 35°C)	20 to 30°C
Humidity	Ordinary Humidity(25 to 85% RH)	50 to 80 %RH

6 Configuration and dimensions

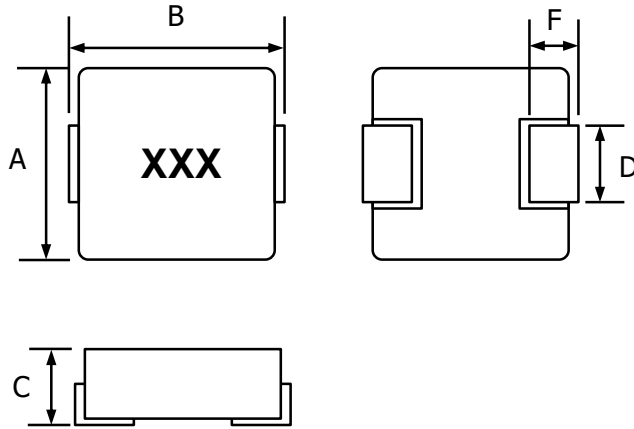

Dimensions in mm

Type	040420
A	4.2 ± 0.25
B	4.7 ± 0.25
C	1.8 ± 0.2
D	2.0 ± 0.3
F	1.0 ± 0.3

Size code	Net weight(grms)
040420	0.18(typ.)

7 Electrical characteristics

Part number	Inductance (uH)	Tolerance (±%)	Test Freq.	I _{rms} (A) Typ.	I _{sat} (A) Typ.	RDC(mΩ) Max.(Typ.)	Marking
AMRU00040420R47MB1	0.47	20	100kHz,0.5V	7	10	14(12)	R47
AMRU000404201R0MB1	1	20	100kHz,0.5V	4.5	7	27(24)	1R0
AMRU000404201R5MB1	1.5	20	100kHz,0.5V	4	6	46(38)	1R5
AMRU000404202R2MB1	2.2	20	100kHz,0.5V	3	5	55(50)	2R2
AMRU000404203R3MB1	3.3	20	100kHz,0.5V	2.7	4.2	83(75)	3R3
AMRU000404204R7MB1	4.7	20	100kHz,0.5V	2.2	3.5	105(95)	4R7
AMRU00040420100MB1	10	20	100kHz,0.5V	1.5	2.3	250(225)	100

Note:

1. Operating temperature range -40°C to 125°C.
2. I_{sat} for inductance drop 30% from its value without current.
3. I_{rms} for a 40°C temperature rise from 25°C ambient.
4. The part temperature (ambient + temp rise) should not exceed 125°C under worst case operating conditions.
Circuit design 125°C under worst case operating conditions. Component placement, PWB trace size and thickness, airflow and other cooling provisions all affect the part temperature. Part temperature should be verified in the end application.
5. Absolute maximum voltage 30V DC. (Based on test method, it may not the same under different application, it is recommended to verify first.)

8 AMRU00040420 Series

8.1 Construction

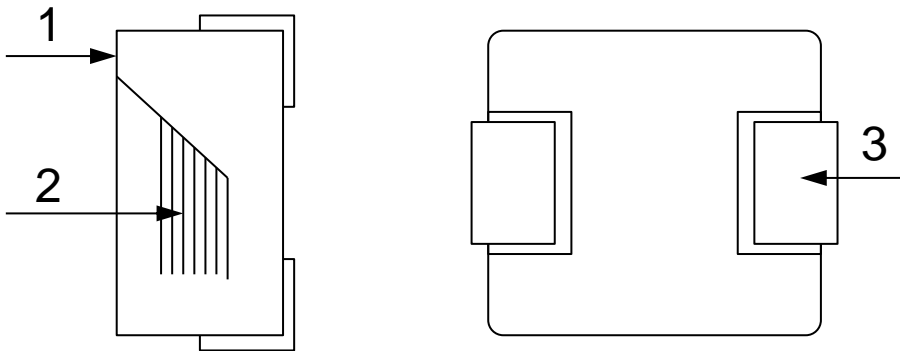

8.2 Material list

Item	Part	Description
1	Magnetic core	Magnetic metal powder
2	Coil	Enameled copper wire
3	Terminals	Copper based terminal

9 Reliability test items

1-1. Mechanical performance

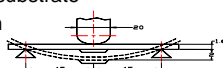
No	Item	Specification	Test Method
1-1-1	Board Flex	The forces applied on the right conditions must not damage the terminal electrode and the ferrite	Refer to AEC-Q200-005 Test device shall be soldered on the substrate Substrate Dimension: 100x40x1.6mm Deflection: 2.0mm Keeping Time: 60sec 
1-1-2	Resistance to Soldering Heat	Appearance: No damage Inductance change shall be within $\pm 10\%$.	Refer to MIL-STD-202 Method 210 Pre-heating: 150°C, 1min Solder Composition: Sn/Ag3.0/Cu0.5(Pb-Free) Solder Temperature: 260 \pm 5°C Immersion Time: 10 \pm 1sec
1-1-3	Solder ability	The electrodes shall be at least 95% covered with new solder coating	Refer to J-STD-002 Pre-heating: 150°C, 1min Solder Composition: Sn/Ag3.0/Cu0.5(Pb-Free) Solder Temperature: 245 \pm 5°C(Pb-Free) Immersion Time: 4 \pm 1sec
1-1-4	Terminal Strength Test	Appearance: No damage	Refer AEC-Q200-006 Soldered on PCB for testing as fig. Force : 1.8kg Keeping Time: 60 seconds.
1-1-5	Resistance to Solvent	There must be no change in appearance or obliteration of marking	Refer to MIL-STD-202 Method 215 Inductors must withstand 6 minutes of alcohol or water. Sample Size : 15 pcs
1-1-6	Vibration	Appearance: No damage Inductance change shall be within $\pm 10\%$.	Refer MIL-STD-202 Method 204 Vibration waveform: Sine waveform Vibration frequency: 10Hz to 2000Hz Vibration acceleration: 5g Sweep rate: 0.764386octave/minute Duration of test: 12 cycles each of 3 orientations, 20 minutes for each cycle Vibration axes: X, Y & Z

1-2. Environmental performance

No	Item	Specification	Test Method
1-2-1	Temperature Cycle	Appearance: No damage Inductance change shall be within $\pm 20\%$	Refer to JESD Method JA-104 Total cycles: 1000 cycles Temperature Cycling Test Conditions : -40 to +125 °C -40°C Soak Mode Condition : 30 minutes 125°C Soak Mode Condition : 30 minutes Measured after exposure in the room condition for 24hrs
1-2-2	Biased Humidity Resistance		Refer to MIL-STD-202 Method 103 Temperature: 85 \pm 2°C Relative Humidity:85% / Time: 1000hrs Measured after exposure in the room condition for 24hrs
1-2-3	High Temperature Exposure (Storage)		Refer to MIL-STD-202 Method 108 Temperature: 125 \pm 3°C / Relative Humidity: 0% Applied Current: Rated Current /Time: 1000hrs Measured after exposure in the room condition for 24hrs
1-2-4	Operational Life		Refer to MIL-PRF-27 Temperature: 85 \pm 3°C Applied Current : Rated Current Time: 1000hrs Measured after exposure in the room condition for 24hrs

10 Recommended IR reflow profile

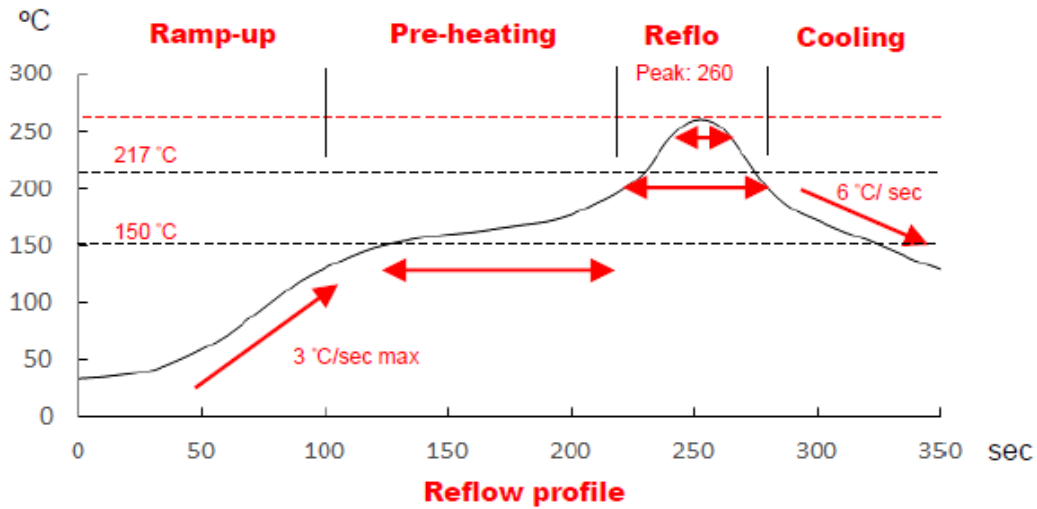

Lead-Free(LF)

Refer to J-STD-020F

Item	Ramp-up	Pre-heating	Reflow	Peak Temp.	Cooling
Temp. scope	R.T. ~150 °C	150 °C~200 °C	217 °C	260±5 °C	Peak Temp. 150 °C
Time spec	-	60~120 sec	60~150 sec	20~40 sec	-

Note:

1. IR reflow times: within 3 times.
2. Nitrogen adopted is recommended while in IR reflow.

11 Packaging

11.1 Packaging- cover tape

The force for tearing off cover tape is 10 to 130 grams.

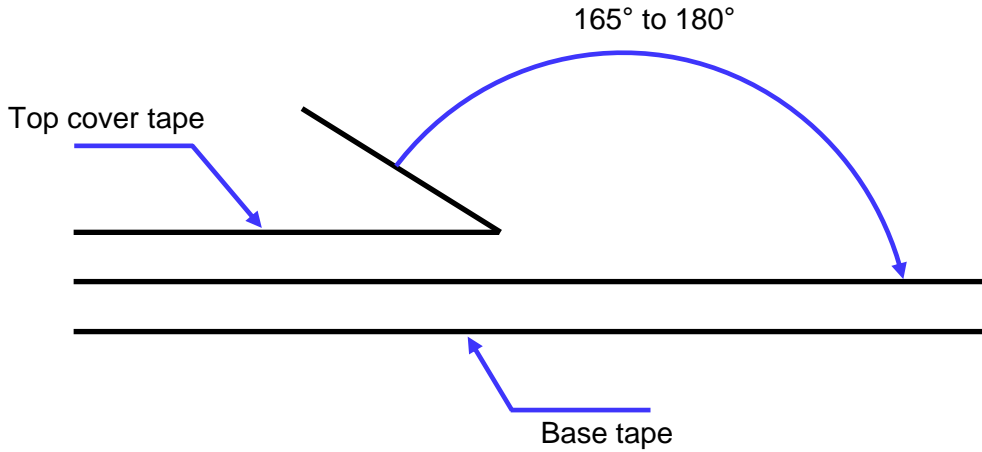

11.2 Packaging quantity

Type	Pcs/Reel
040420	2000

11.3 Reel dimensions

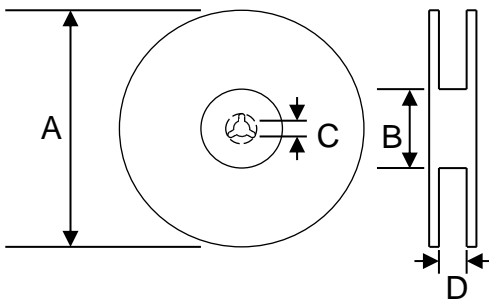

Dimensions in mm

Type	A	B	C	D
040420	330	100	13	13

11 Packaging

11.4 Tape dimensions in mm

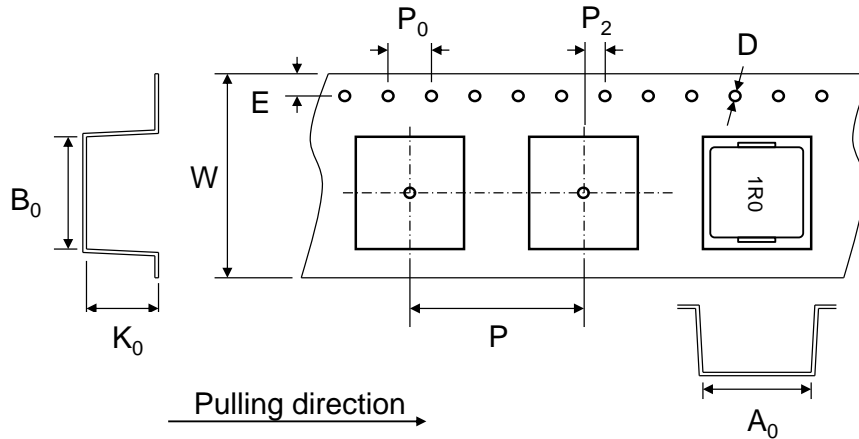

Type	A ₀	B ₀	K ₀	D	E	W	P	P ₀	P ₂
040420	4.5	5.1	2.4	1.5	1.75	12	8	4	2

12 Recommended pattern

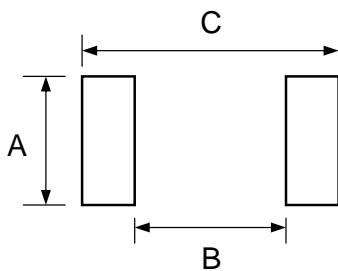

Dimensions in mm

Type	A	B	C
040420	2.5	2.2	5.2

13 Note

1. Please make sure that your product has been evaluated and confirmed against your specifications when our product is mounted to your product.
2. Don't design/mount any components in contact with this product
3. The moisture sensitivity level (MSL) of products is classified as level 1.
4. Shelf life: 1 years from the date of shipment.

14 Graph:

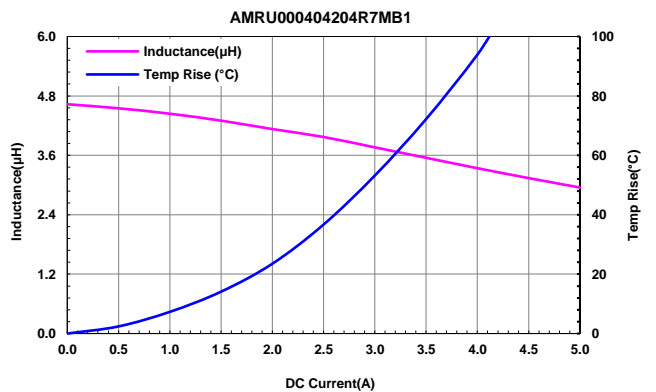
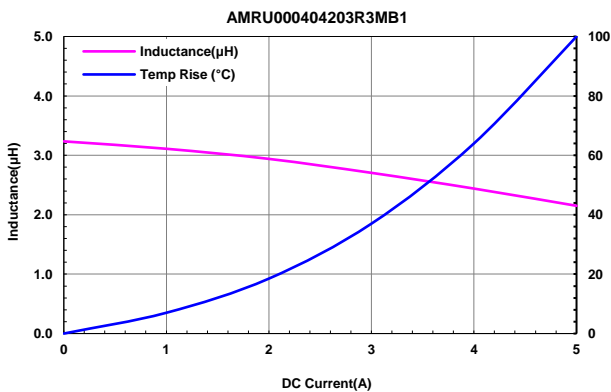
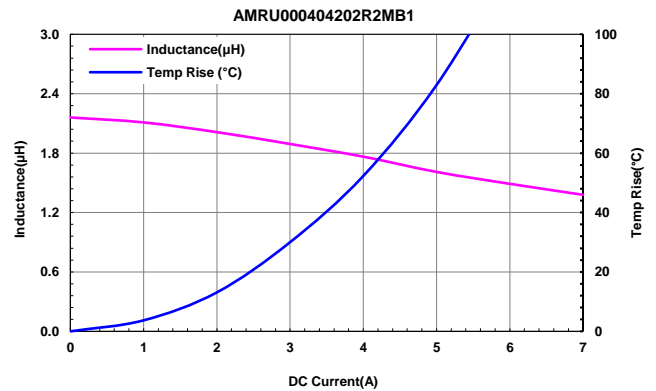
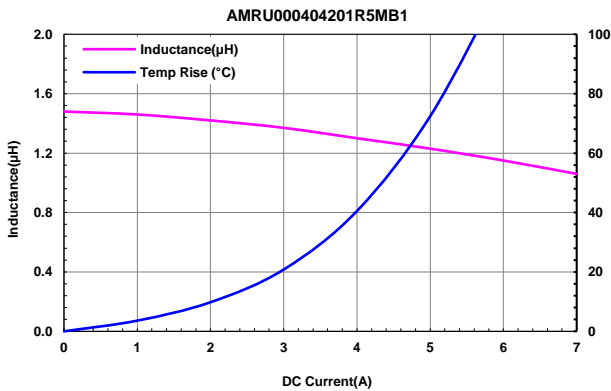
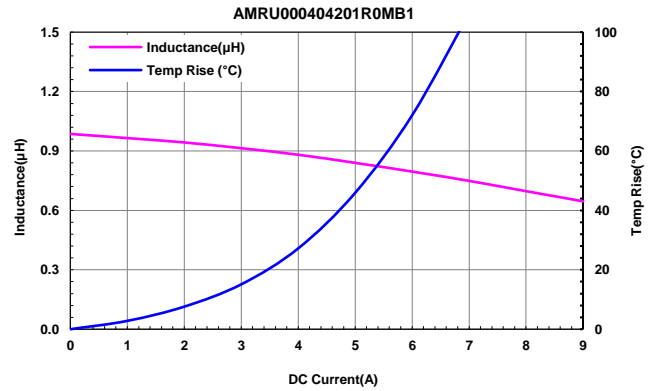
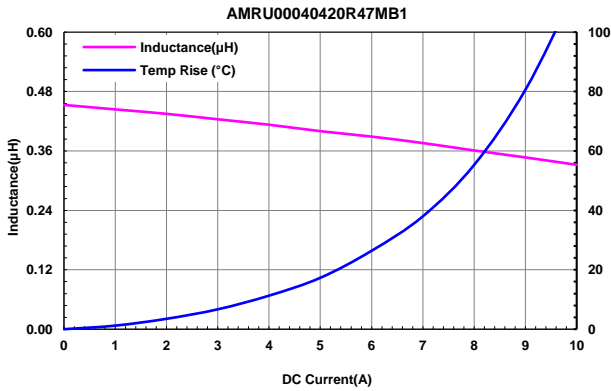

14 Graph:

