

# Power Inductor

## Automotive Grade

### AWVS Series



#### Overview

Power inductors are passive electronic components used in various circuits to store energy in a magnetic field when electrical current flows through them. They are critical in filtering, energy storage, and noise suppression in power electronic systems.

They are designed to handle higher currents and are optimized for minimal power loss and thermal efficiency.

#### Benefits

1. Automotive grade available
2. No thermal aging
3. High current and efficiency, Magnetic epoxy sealing(Seme-shield)

#### Applications

1. Automotive Systems for Infotainment, MCU, Dashboard, CCD Module
2. Media player, Audio class
3. Net working, LCD Panel/TV,
4. Base stations, 5G infrastructure, and signal processing systems.
5. Telematics

#### Product Information

Series	L (mm)	W(mm)	T (mm)	Inductance (μH)
AWVS	3.2	2.5	1.5	0.22 ~ 1200
	3.2	2.5	1.5	
	4.0	4.0	1.2	
	4.0	4.0	1.5~2.0	
	5.0	5.0	1.7~2.2	
	5.0	5.0	4.0	
	5.0	5.0	3.7~4.2	
	6.0	6.0	1.7~2.2	
	6.0	6.0	2.5~3.0	
	6.0	6.0	4.2~4.7	
	6.0	6.0	4.5	
	8.0	8.0	3.7~4.2	
	8.0	8.0	4.0	



# AWVS00606028 Series Specification

AEC-Q200

**1 Scope:** This specification applies to Wire Wound Power Inductors

**2 Part Numbering:**

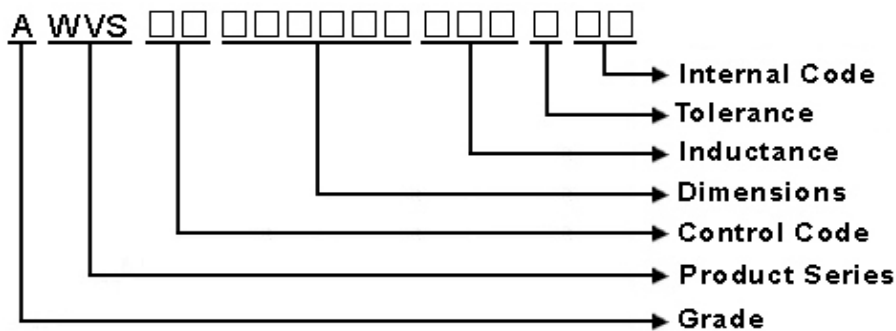

**3 Rating:**

Operating Temperature: - 4 0 °C ~ 1 2 5 °C(Including self - temperature rise)

Storage Temperature: - 4 0 °C ~ 1 2 5 °C

(The storage temperature range is for after the assembly)

**4 Marking:**

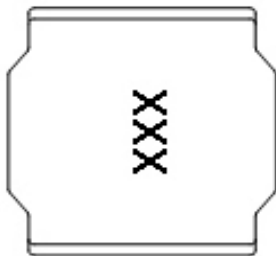

**Ex Marking : 2R2**

**Marking color : Black**

**5 Standard Testing Condition**

	Unless otherwise specified	In case of doubt
Temperature	Ordinary Temperature(15 to 35°C)	20 to 30°C
Humidity	Ordinary Humidity(25 to 85% RH)	50 to 80 %RH

# AWVS00606028 Series Specification

AEC-Q200

## 6 Configuration and Dimensions:

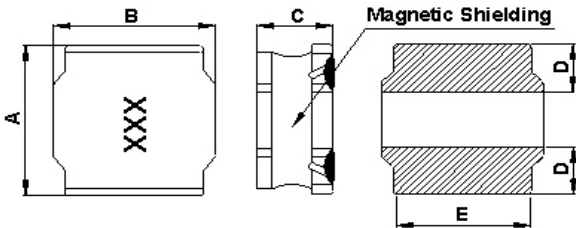

Dimensions in mm

TYPE	606028
A	6.0±0.2
B	6.0±0.2
C	2.8 <sup>+0.2</sup> <sub>-0.3</sub>
D	1.9±0.3
E	4.8 typ.

Net Weight (grams)

SIZE CODE	Net Weight (grams)
606028	0.367 (typ).

## 7 Electrical Characteristics:

Part No.	Inductance (uH)	Test Freq.	RDC (mΩ)±30%	Isat(A) Typ.(Max)	Irms(A) Typ.(Max)	Tolerance (±%)	Marking
AWVS006060281R0□00	1.0	100kHz,1V	13	7.60(6.80)	5.20(4.60)	20,30	1R0
AWVS006060281R5□00	1.5	100kHz,1V	16	6.30(5.60)	4.80(4.30)	20,30	1R5
AWVS006060281R8□00	1.8	100kHz,1V	20	6.00(5.40)	4.50(4.05)	20,30	1R8
AWVS006060282R2□00	2.2	100kHz,1V	20	5.40(4.80)	4.00(3.60)	20,30	2R2
AWVS006060282R7□00	2.7	100kHz,1V	26	4.90(4.40)	3.70(3.30)	20,30	2R7
AWVS006060283R3□00	3.3	100kHz,1V	28	4.30(3.80)	3.50(3.10)	20,30	3R3
AWVS006060283R9□00	3.9	100kHz,1V	32	4.00(3.60)	3.40(3.06)	20,30	3R9
AWVS006060284R7□00	4.7	100kHz,1V	38	3.70(3.30)	3.20(2.80)	20,30	4R7
AWVS006060286R0□00	6.0	100kHz,1V	45	3.30(2.90)	2.80(2.50)	20,30	6R0
AWVS006060286R8□00	6.8	100kHz,1V	50	3.10(2.70)	2.70(2.40)	20,30	6R8
AWVS00606028100□00	10	100kHz,1V	65	2.50(2.20)	2.30(2.00)	20,30	100
AWVS00606028150□00	15	100kHz,1V	95	2.00(1.80)	1.80(1.60)	20,30	150
AWVS00606028220□00	22	100kHz,1V	135	1.60(1.40)	1.50(1.30)	20,30	220
AWVS00606028330□00	33	100kHz,1V	220	1.30(1.10)	1.40(1.20)	20,30	330
AWVS00606028470□00	47	100kHz,1V	320	1.10(0.99)	1.00(0.90)	20,30	470
AWVS00606028680□00	68	100kHz,1V	420	0.98(0.88)	0.90(0.81)	20,30	680
AWVS00606028101□00	100	100kHz,1V	600	0.82(0.73)	0.8(0.72)	20,30	101
AWVS00606028121□00	120	100kHz,1V	770	0.76(0.68)	0.70(0.63)	20,30	121

**NOTE:** □-tolerance M=±20% / T=±30%

1. Operating temperature range - 4 0°C ~ 1 2 5°C (Including self - temperature rise)

2. Isat for Inductance drop 30% from its value without current.

3. Irms for a 40°C temperature rise from 25°C ambient.

**8 AWVS00606028 Series**

**8.1 Construction:**

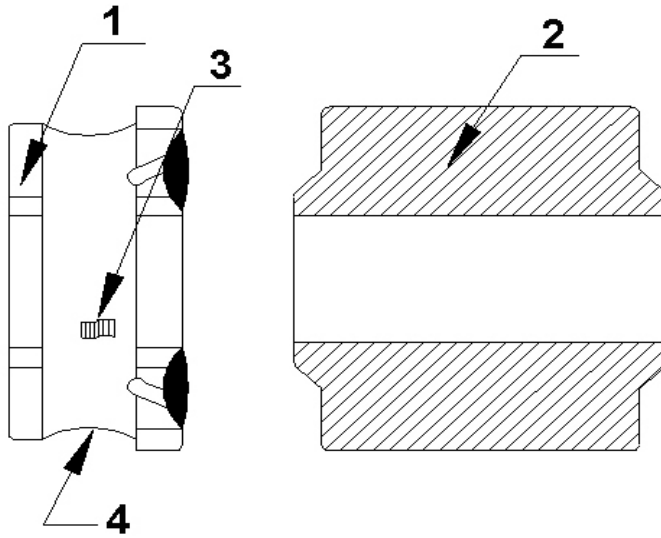

**8.2 Material List:**

NO	Part	Material
1	Core	Ferrite
2	Terminal	Ag/Ni/Sn
3	Wire	Copper(180°C)
4	Epoxy	Magnetic powder resin

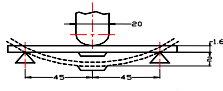
<b>9 Reliability of Wire Wound Power Inductors</b>			
<b>1-1.Mechanical Performance</b>			
	<b>Item</b>	<b>Specification</b>	<b>Test Method</b>
1-1-1	Board Flex	The forces applied on the right conditions must not damage the terminal electrode and the ferrite.	Test device shall be soldered on the substrate Substrate Dimension: 100x40x1.6mm Deflection: 2.0mm Keeping Time: 60 sec 
1-1-2	Terminal Strength	The chip must not damage the terminal electrode and the ferrite.	Appendix 1 Note(AEC-Q200-005):Force of 1.8 kg for 60 seconds.
1-1-3	Solderability	The electrodes shall be at least 95% covered with new solder coating.	Pre-heating: 150℃, 1min Solder Composition: Sn/3.0Ag/0.5Cu Solder Temperature: 245±5℃ Immersion Time: 4±1sec
1-1-4	Resistance to Soldering Heat	Appearance:No damage Inductance change shall be within ±10%.	Pre-heating: 150℃, 1min Solder Composition: Sn/Ag3.0/Cu0.5 Solder Temperature: 260±5℃ Immersion Time: 10±1sec
1-1-5	Resistance to Solvents	There must be no change in appearance or obliteration of marking.	Inductors must withstand 6 minutes of alcohol or water.
1-1-6	Mechanical Shock	The forces applied on the right conditions must not damage the terminal electrode and the ferrite.	Pulse shape : Half-sine waveform Impact acceleration : 100 g Pulse duration : 6 ms Number of shocks : 18 shocks (3 shocks for each face) Orientation : Bottom, top, left, right, front and rear faces
1-1-7	Vibration	Appearance:No damage Inductance change shall be within ±10%.	Vibration waveform: Sine waveform Vibration frequency: 10Hz~2000Hz Vibration acceleration: 5g Sweep rate: 0.764386octave/minute Duration of test: 12 cycles each of 3 orientations 20 minutes for each cycle Vibration axes: X, Y & Z
<b>1-2.Environmental Performance</b>			
No	Item	Specification	Test Method
1-2-1	High Temperature Exposure (Storage)	Appearance:No damage (for microscope of CASTOR MZ-4 20X) Inductance change shall be within ±10%.	Temperature: 125±3℃ Time: 1000hrs Measured after exposure in the room condition for 24hrs
1-2-2	Operational Life		Temperature: 125±2℃ Applied Current : Rated Current Time: 1000± 24 hrs Measured after exposure in the room condition for 24hrs
1-2-3	Biased Humidity		Temperature: 85±2℃ Relative Humidity: 85% Time: 1000hrs Measured after exposure in the room condition for 24hrs
1-2-4	Temperature Cycling		Total cycles: 1000 cycles Temperature Cycling Test Conditions : -40 to +125 ℃ Soak Mode Condition : 30 minutes Measured after exposure in the room condition for 24hrs
1-2-5	ESD		Test mode : Contact Discharge Discharge level : ±6KV, Discharge interval : 1 second Polarity of the output voltage : Positive and negative Number of discharge : Discharge +/- for 1 time for the 2 test points. Test Mode : Air Discharge Discharge level : ±12KV, ±16KV, ±25KV Discharge interval : < 5 seconds Polarity of the output voltage : Positive and negative Number of discharge : Discharge +/- for 1 time for the 1~2 test points.

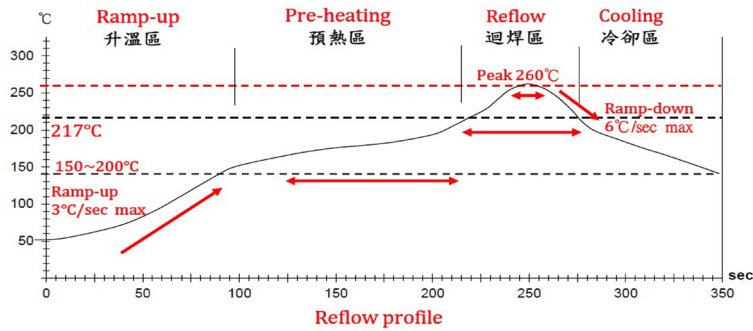

Lead-Free(LF)標準溫度分析範圍

Refer to J-STD-020C

管制項目 Item.	升温區 Ramp-up	預熱區 Pre-heating	迴焊區 Reflow	Peak Temp	冷卻區 Cooling
溫度範圍 Temp.scope	R.T ~ 150°C	150°C ~ 200°C	Above 217°C	260±5°C	Peak Temp.~150°C
標準時間 Time spec.	-	60 ~ 180 sec	60 ~ 150 sec	20 ~ 40 sec	-
實際時間 Time result	-	75 ~ 100 sec	90 ~ 120 sec	20 ~ 35 sec	-

NOTE :

1. Re-flow possible times : within 2 times
2. Nitrogen adopted is recommended while in re-flow
3. Products can only be soldered with reflow

**10 Packaging:**

**10.1 Packaging -Cover Tape**

The force for tearing off cover tape is 10 to 130 grams in the arrow direction.

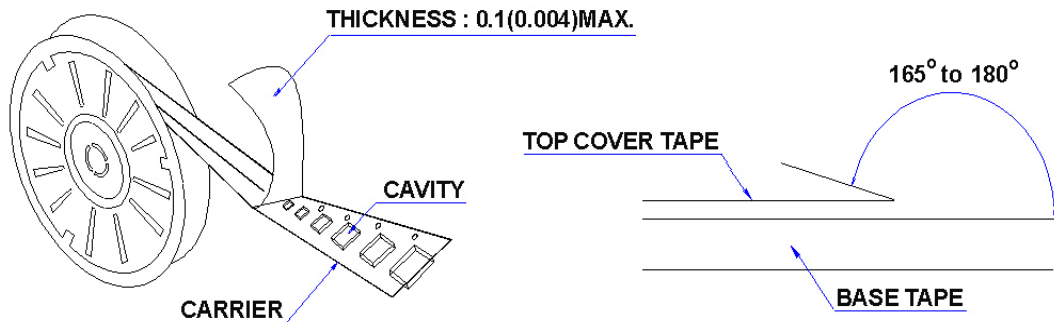

**10.2 Packaging Quantity**

TYPE	PCS/REEL
606028	1500

**10.3 Reel Dimensions**

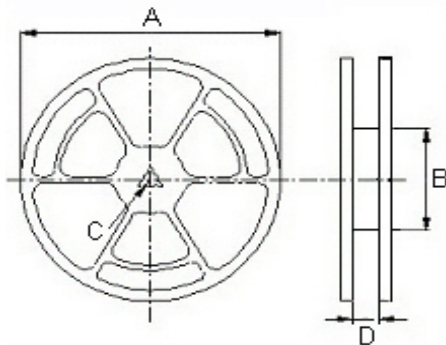

Dimensions in mm

TYPE	A	B	C	D
606028	330	100	13	16

**10 Packaging:**

**10.4 Tape Dimensions in mm**

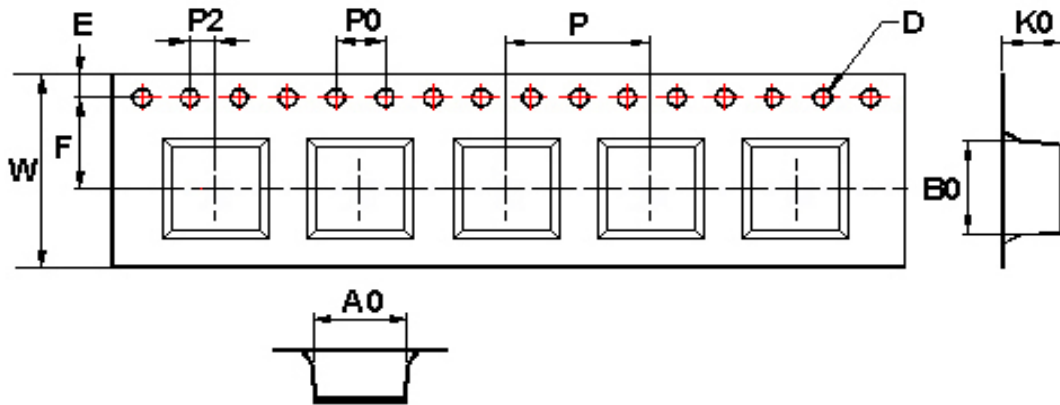

TYPE	A0	B0	K0	D	E	F	W	P	P0	P2
606028	6.25	6.25	3.0	1.55	1.75	7.5	16	12	4	2

**11 Recommended Land Pattern:**

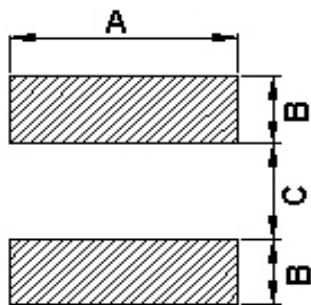

Dimensions in mm

TYPE	A	B	C
606028	5.7	1.8	2.6

**12 Note:**

1. Please make sure that your product has been evaluated and confirmed against your specifications when our product is mounted to your product.
2. Do not knock nor drop.
3. All the items and parameters in this product specification have been prescribed on the premise that our product is used for the purpose, under the condition and in the environment agreed upon between you and us. You are requested not to use our product deviating from such agreement.
4. The storage period is less than 12 months. Be sure to follow the storage conditions (Temperature: 5 to 40°C, Humidity: 10 to 75% RH or less).  
If the storage period elapses, the soldering of the terminal electrodes may deteriorate.
5. Do not use or store in locations where there are conditions such as gas corrosion (salt, acid, alkali, etc.).
6. The moisture sensitivity level (MSL) of products is classified as level 1.

**12** Note:

7. Void Appearance tolerance Limit

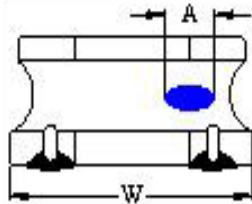

**Exposed wire tolerance limit of coating resin part on product side.**  
The unilateral should be no more than two holes.

$$A \leq W/2 \text{ GOOD}$$

$$A > W/2 \text{ NG}$$

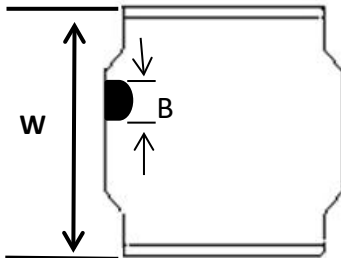

**The appearance standard of the chipping size in top side.**

$$B \leq W/8 \text{ GOOD}$$

$$B > W/8 \text{ NG}$$

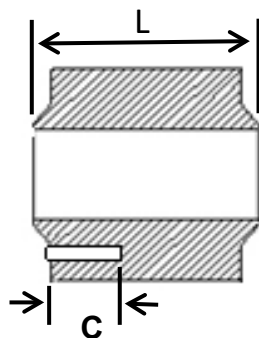

**Electrode appearance criterion for exposed wire.**

$$C \leq L/4 \text{ GOOD}$$

$$C > L/4 \text{ NG}$$

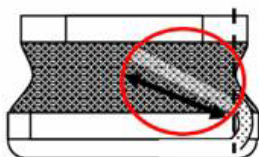

**External appearance criterion for exposed wire**

Exposed end of the winding wire at the side should be acceptable.

**13** Graph: AWVS00606028 Series Graph

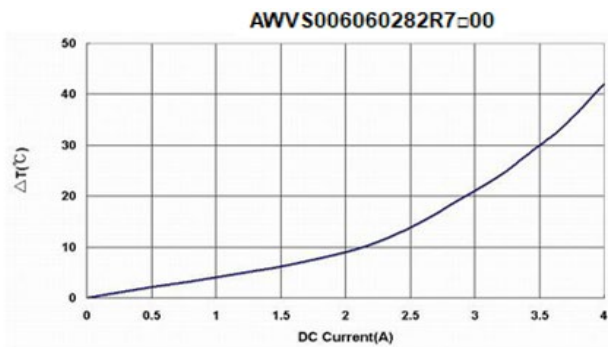
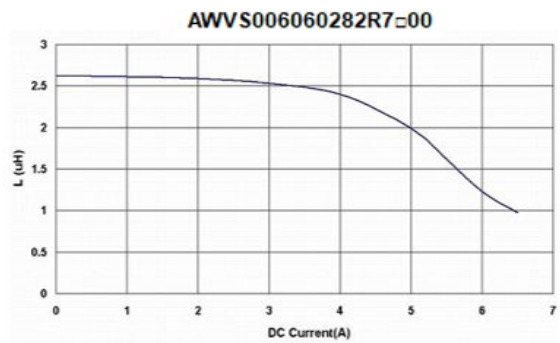
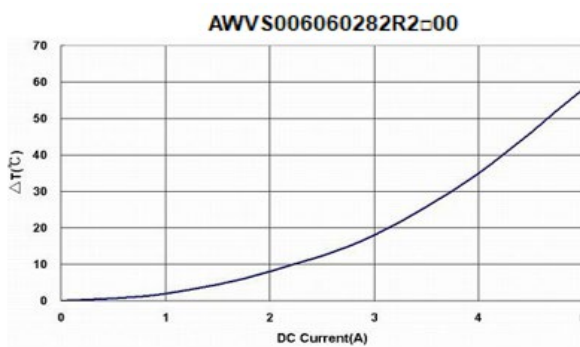
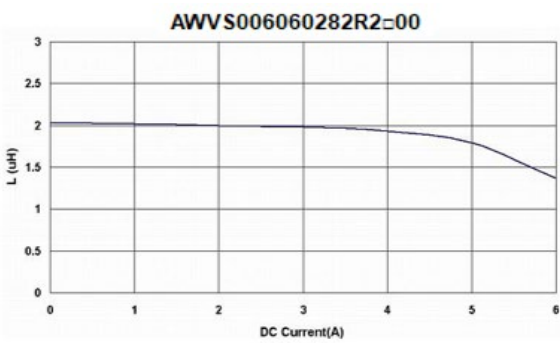
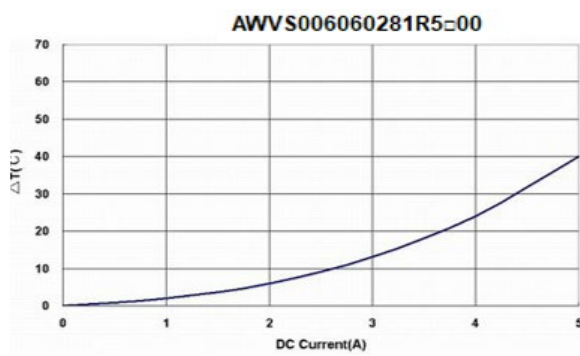
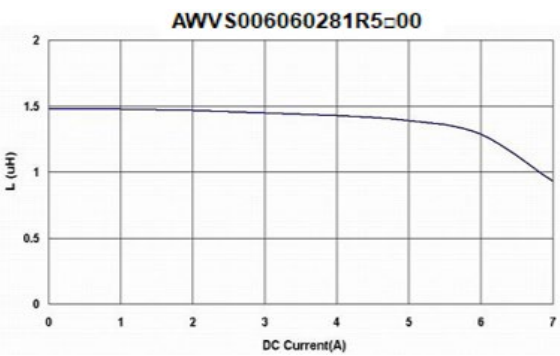
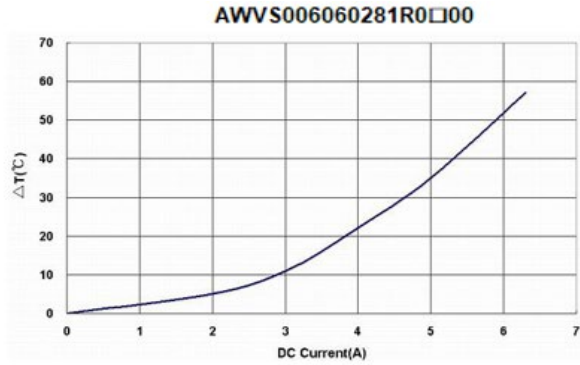
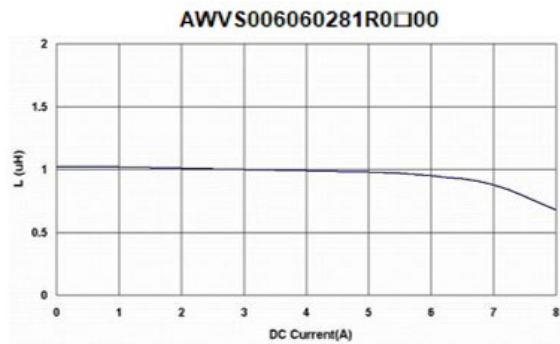

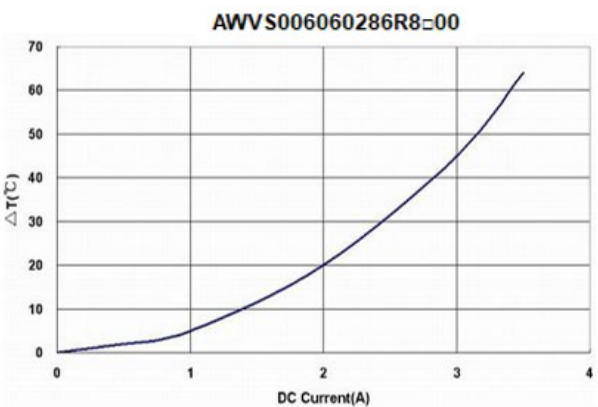
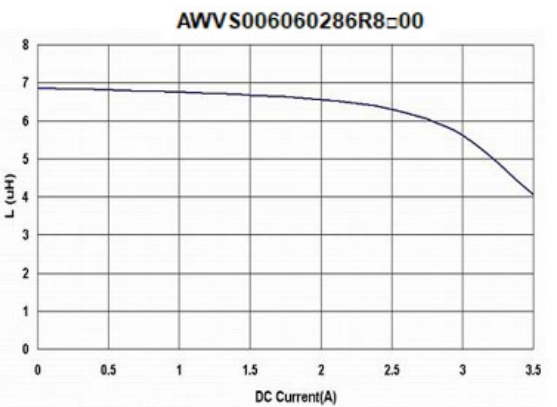
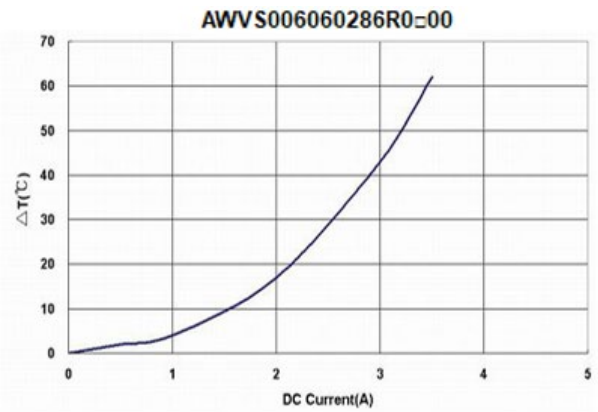
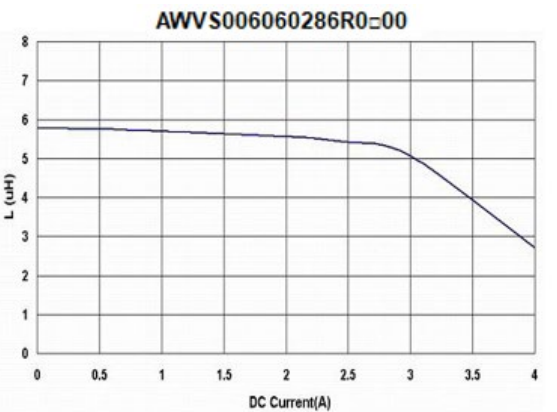
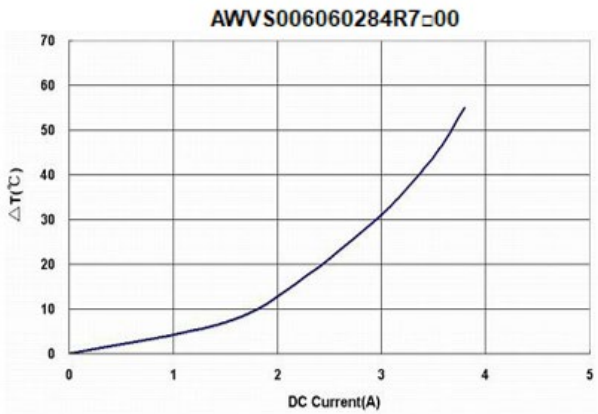
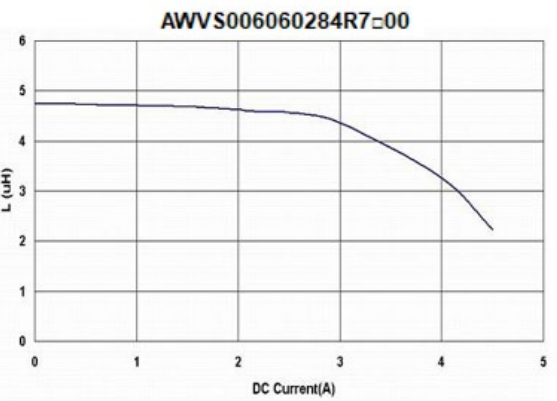
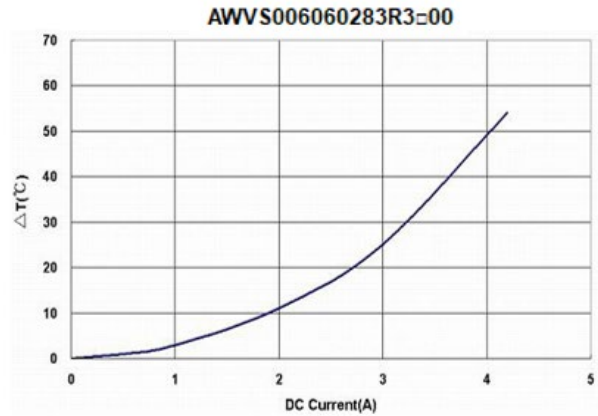
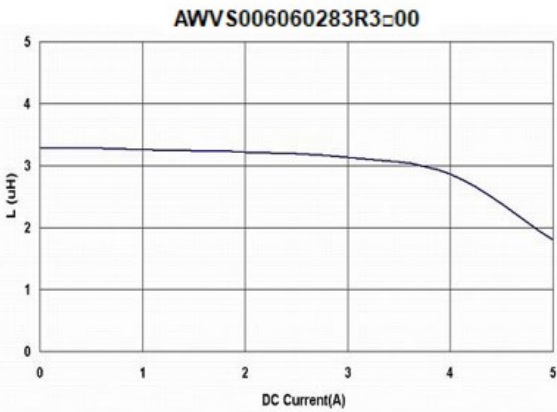

# AWVS00606028 Series Specification

AEC-Q200

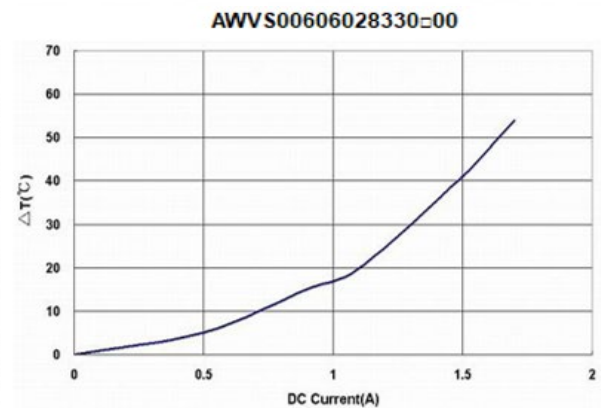
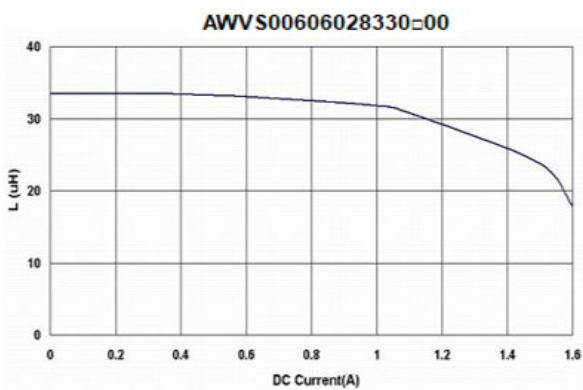
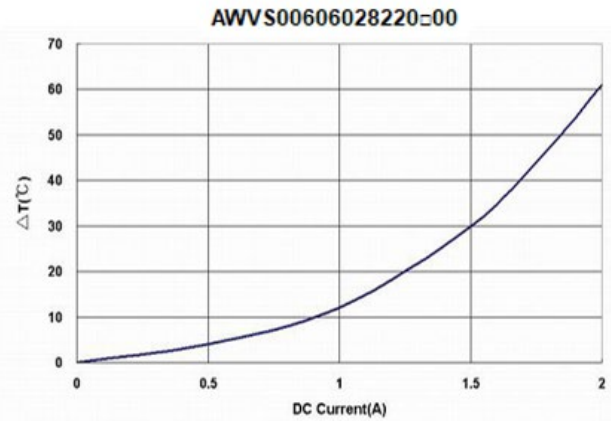
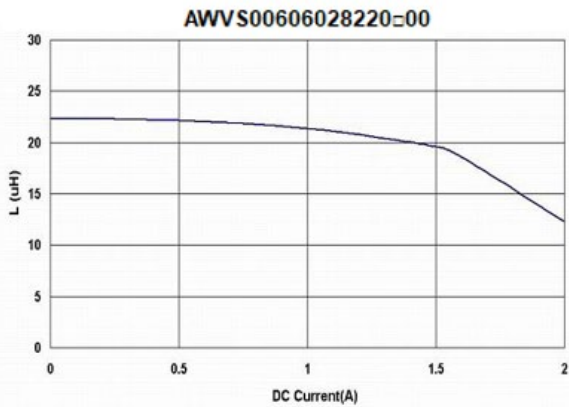
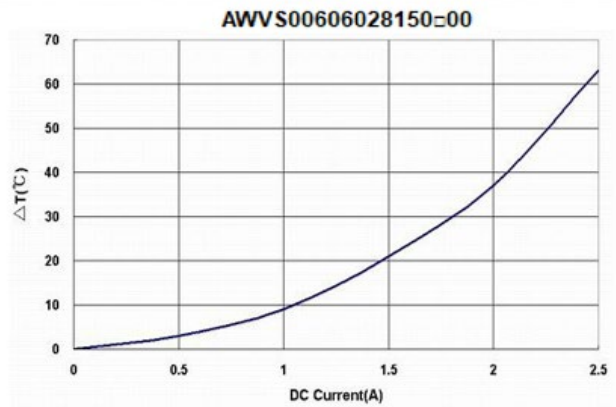
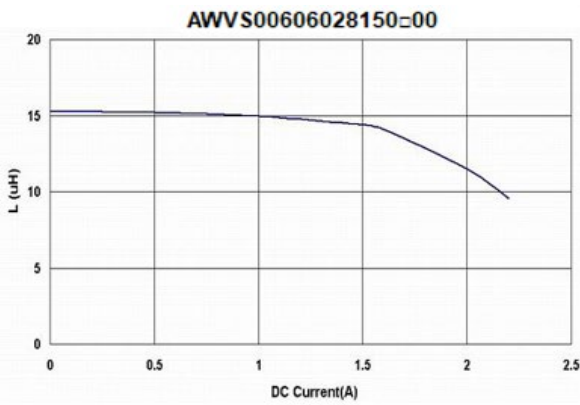
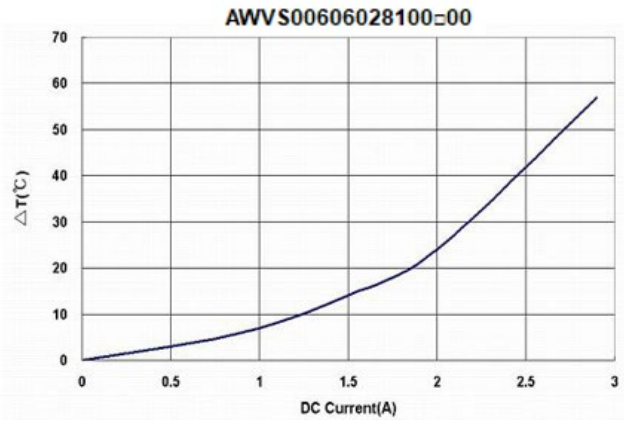
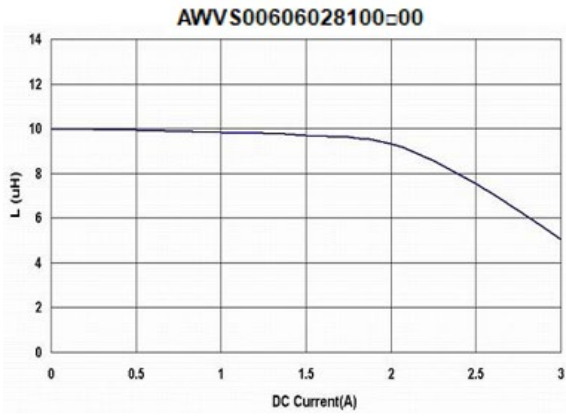

# AWVS00606028 Series Specification

AEC-Q200

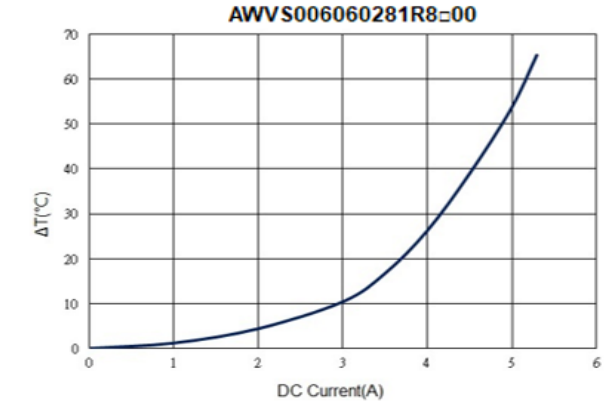
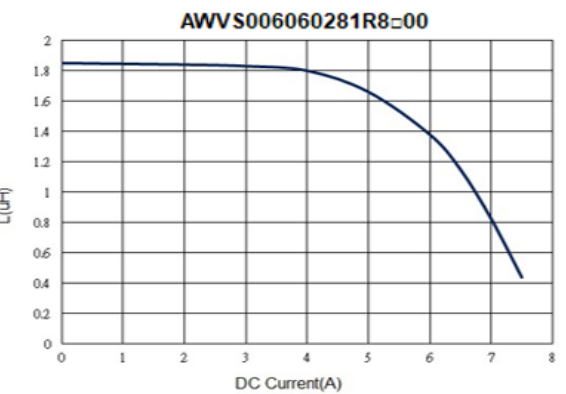
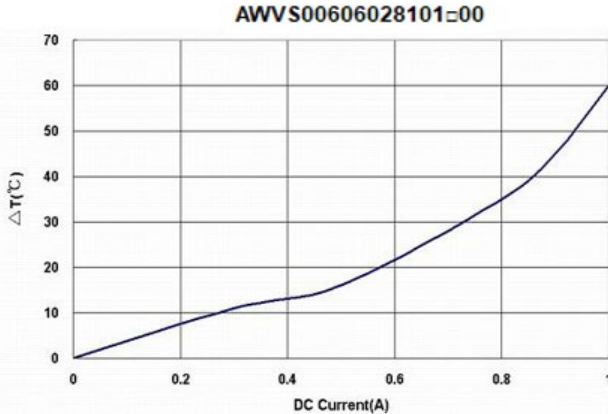
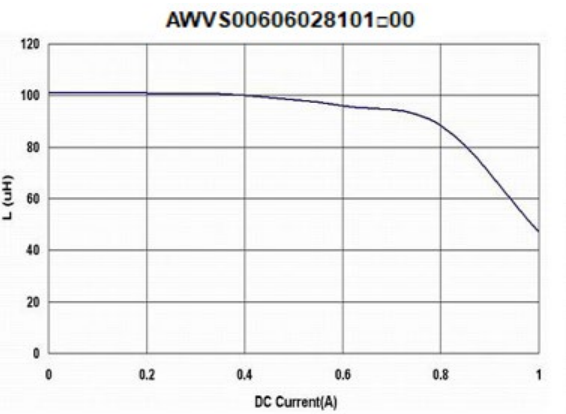
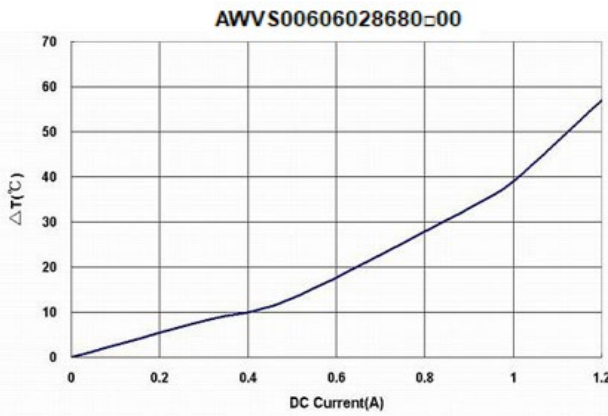
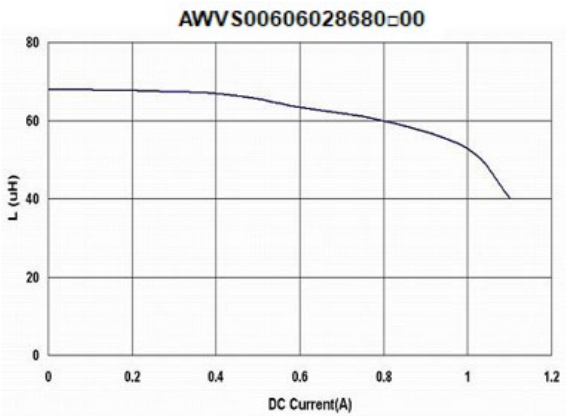
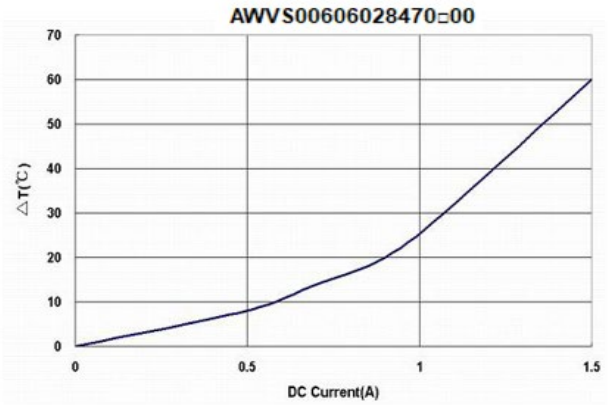
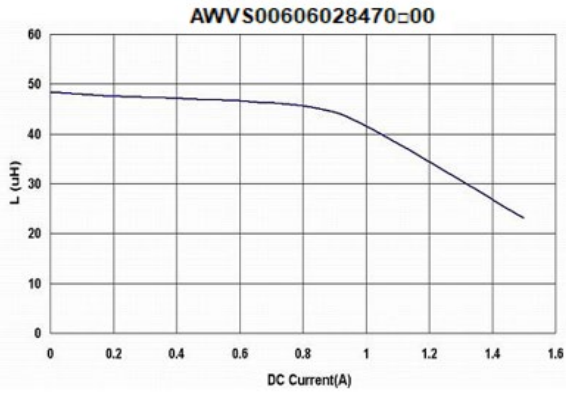

# AWVS00606028 Series Specification

AEC-Q200

