

Power Inductor



BMRB Series



Overview

BMRx series is designed for low profile type with low RDC and ultra large current. Its molded magnetic shielded type is suitable for high-density mounting and ultra low buzz noise. Soldering conditions can be easily confirmed when mounting onto the board. This series also provides customers with embossed carrier type packaging for automatic mounting machine.

Benefits

1. High rated current
2. Ultra low buzz noise

Applications

1. DC-DC converters
2. Switches and servers
3. DC-DC converters, inverters, and battery management systems.
4. Base stations, 5G infrastructure
5. Consumer Electronics: Smartphones, laptops, tablets, wearable devices, and gaming consoles.

Product Information

Series	L (mm)	W(mm)	T (mm)	Inductance (μH)
BMRB	4.1	4.6	1.2	0.1 ~ 15
	5.4	5.7	1.2	
	5.2	5.4	1.2	
	5.4	5.7	1.5	
	5.4	5.7	1.8	
	5.2	5.4	1.6	
	6.6	7.3	1.2	
	6.6	7.3	1.3	
	6.6	7.3	1.6	
	6.6	7.3	2.4	
	6.6	7.3	3.0	
	6.6	7.3	5.0	



BMRB00060618 Series Specification

1 Scope This specification applies to large current and low loss SMD power inductor.

2 Part numbering

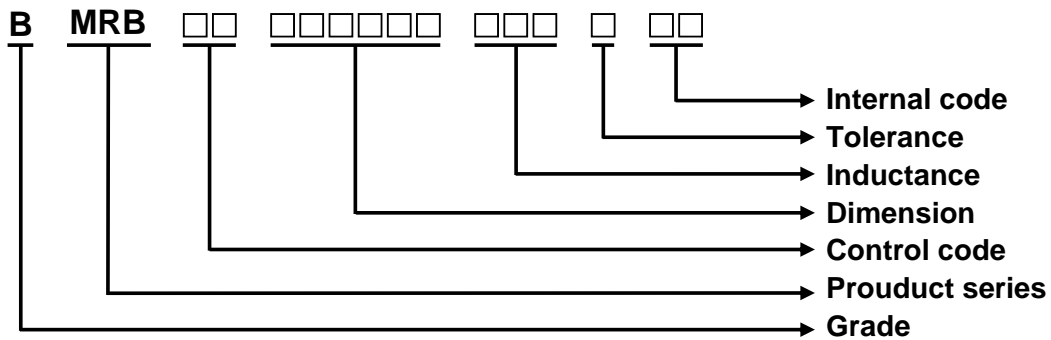

3 Temperature rating

Operating Temperature: -55°C to 125°C.

Storage Temperature: (on tape & reel): -20°C to +40°C; 75% RH max.

4 Marking

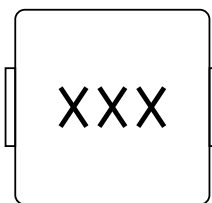

Marking : 1R0

5 Standard testing condition

	Unless otherwise specified	In case of doubt
Temperature	Ordinary Temperature(15 to 35°C)	20 to 30°C
Humidity	Ordinary Humidity(25 to 85% RH)	50 to 80 %RH

BMRB00060618 Series Specification

6 Configuration and dimensions

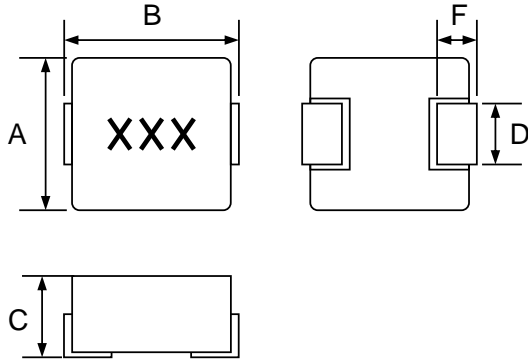

Dimensions in mm

Type	060618
A	6.6 ± 0.2
B	6.95 ± 0.35
C	1.6 ± 0.2
D	3.0 ± 0.3
F	1.6 ± 0.5

Size Code	Net weight(grms)
060618	0.45(typ.)

7 Electrical characteristics

Part number	Inductance (uH)	Tolerance (±%)	Test Freq.	I _{rms} (A) Typ.	I _{sat} (A) Typ.	RDC (mΩ) Max.(Typ.)	Marking
BMRB00060618R22MA1	0.22	20	100kHz,0.5V	14	29	5.2(4.5)	R22
BMRB00060618R33MA1	0.33	20	100kHz,0.5V	12	22	6.8(5.2)	R33
BMRB00060618R47MA1	0.47	20	100kHz,0.5V	11	18	8.4(7.3)	R47
BMRB00060618R68MA1	0.68	20	100kHz,0.5V	9	17	12.7(10.8)	R68
BMRB000606181R0MA1	1	20	100kHz,0.5V	7	14	17(14.5)	1R0
BMRB000606181R5MA1	1.5	20	100kHz,0.5V	6.5	12	26(20)	1R5
BMRB000606182R2MA1	2.2	20	100kHz,0.5V	6	10	35(31)	2R2
BMRB000606184R7MA1	4.7	20	100kHz,0.5V	3.5	5	70((68)	4R7
BMRB000606186R8MA1	6.8	20	100kHz,0.5V	2.8	3.5	110(101)	6R8
BMRB00060618100MA1	10	20	100kHz,0.5V	2.3	2.5	155(140)	100

Note:

1. Operating temperature range -55°C to 125°C.
2. I_{sat} for Inductance drop 30% from its value without current.
3. I_{rms} for a 40°C temperature rise from 25°C ambient.
4. The part temperature (ambient + temp rise) should not exceed 125°C under worst case operating conditions. Circuit design 125°C under worst case operating conditions. Component placement, PCB trace size and thickness, airflow and other cooling provisions all affect the part temperature. Part temperature should be verified in the end application.
5. Absolute maximum voltage 30V DC. (Based on test method, it may not the same under different application, it is recommended to verify first.)

BMRB00060618 Series Specification

8 BMRB00060618 Series 8.1 Construction

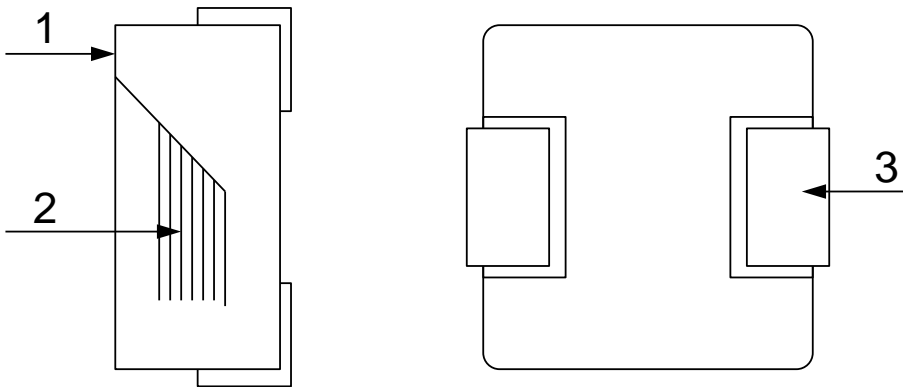

8.2 Material List

Item	Part	Description
1	Magnetic core	Magnetic metal powder
2	Coil	Enameled copper wire
3	Terminals	Copper based terminal

BMRB00060618 Series Specification

9 Reliability test items

1-1.Mechanical Performance

No	Item	Specification	Test Method
1-1-1	Vibration	Appearance: No damage Inductance: within $\pm 10\%$ of initial value	Test device shall be soldered on the substrate Oscillation Frequency: 10 to 55 to 10Hz for 1min Amplitude: 1.5mm Time: 2hrs for each axis (X, Y & Z), total 6hrs
1-1-2	Resistance to Soldering Heat	Appearance: No damage	Pre-heating: 150°C, 1min Solder Composition: Sn/Ag3.0/Cu0.5 Solder Temperature: 260 \pm 5°C Immersion Time: 10 \pm 1sec
1-1-3	Solder ability	The electrodes shall be at least 95% covered with new solder coating	Pre-heating: 150°C, 1min Solder Composition: Sn/Ag3.0/Cu0.5 Solder Temperature: 245 \pm 5°C Immersion Time: 4 \pm 1sec
1-1-4	Resistance to solvent	There must be no change in appearance or obliteration of marking.	Inductors must withstand 6 minutes of alcohol or water.

1-2.Environmental Performance

No	Item	Specification	Test Method															
1-2-1	Temperature Shock	Appearance: No damage Inductance: within $\pm 10\%$ of initial value	10 cycles (Air to Air) 1 cycles shall consist of: 30 minutes exposure to -55°C 30 minutes exposure to 125°C 15 seconds maximum transition between temperatures															
1-2-2	Temperature Cycle		One cycle: <table border="1" style="width: 100%; border-collapse: collapse;"> <thead> <tr> <th>Step</th> <th>Temperature (°C)</th> <th>Time (min)</th> </tr> </thead> <tbody> <tr> <td>1</td> <td>-55\pm3</td> <td>30</td> </tr> <tr> <td>2</td> <td>25\pm2</td> <td>3</td> </tr> <tr> <td>3</td> <td>125\pm3</td> <td>30</td> </tr> <tr> <td>4</td> <td>25\pm2</td> <td>3</td> </tr> </tbody> </table>	Step	Temperature (°C)	Time (min)	1	-55 \pm 3	30	2	25 \pm 2	3	3	125 \pm 3	30	4	25 \pm 2	3
Step	Temperature (°C)		Time (min)															
1	-55 \pm 3		30															
2	25 \pm 2		3															
3	125 \pm 3	30																
4	25 \pm 2	3																
1-2-3	Humidity Resistance	Temperature: 40 \pm 2°C Relative Humidity: 90 ~ 95% Time: 1000hrs Measured after exposure in the room condition for 24hrs																
1-2-4	Heat Life	Temperature: 85 \pm 3°C Relative Humidity: 20% Applied Current: Rated Current Time: 1000hrs Measured after exposure in the room condition for 24hrs																
1-2-5	Cold Resistance	Temperature: -55 \pm 3°C Relative Humidity: 0% Time: 1000hrs Measured after exposure in the room condition for 24hrs																

BMRB00060618 Series Specification

10 Recommended IR reflow profile

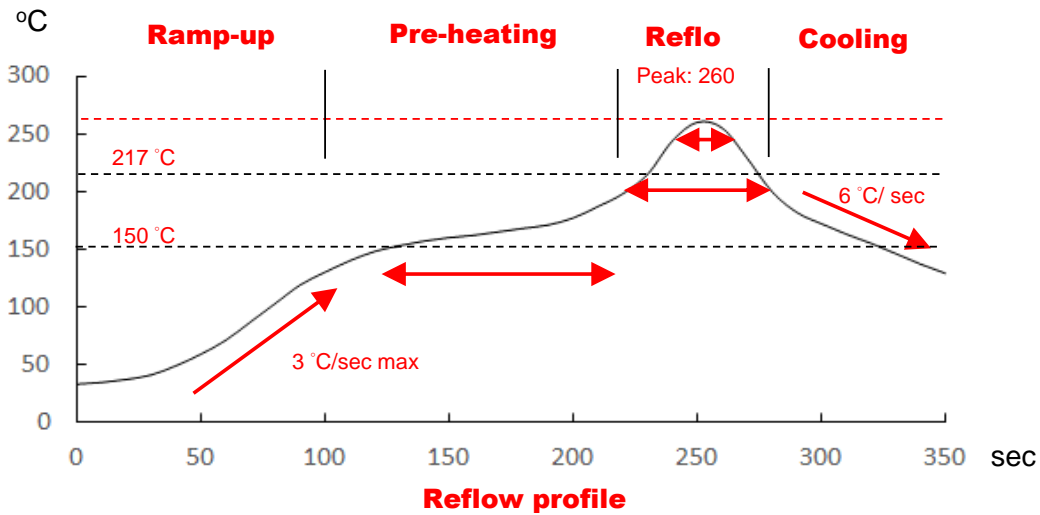

Lead-Free(LF)

Refer to J-STD-020F

Item	Ramp-up	Pre-heating	Reflow	Peak Temp.	Cooling
Temp. scope	R.T. ~150 °C	150 °C~200 °C	217 °C	260±5 °C	Peak Temp. 150 °C
Time spec	-	60~120 sec	60~150 sec	20~40 sec	-

Note:

1. IR reflow times: within 3 times.
2. Nitrogen adopted is recommended while in IR reflow.

BMRB00060618 Series Specification

11 Packaging

11.1 Packaging-cover tape

The force for tearing off cover tape is 10 to 130 grams.

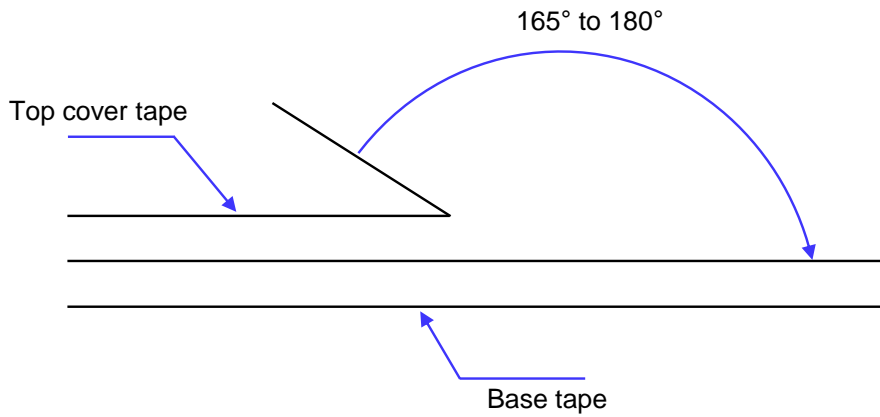

11.2 Packaging quantity

Type	pcs/reel
060618	1000

11.3 Reel dimensions

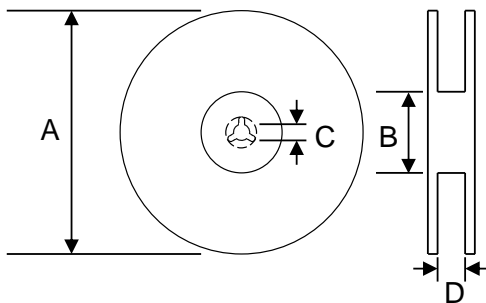

Dimensions in mm

Type	A	B	C	D
060618	330	100	13	16

BMRB00060618 Series Specification

11 Packaging

11.4 Tape dimensions in mm

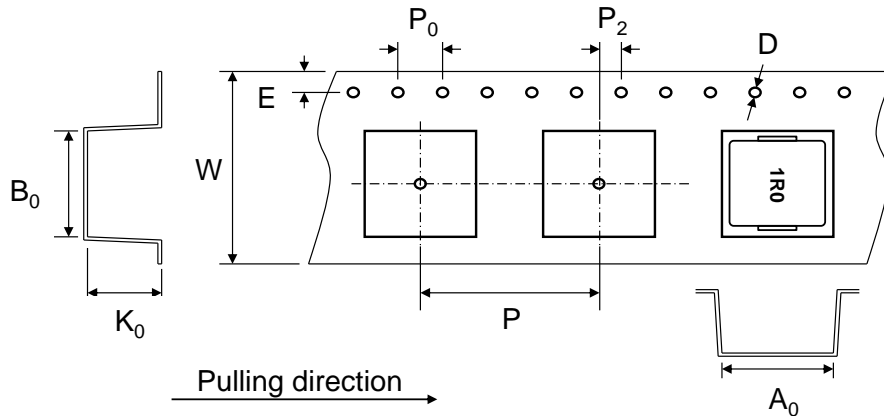

Type	A_0	B_0	K_0	D	E	W	P	P_0	P_2
060618	6.9	7.6	2.1	1.5	1.75	16	12	4	2

12 Recommended pattern

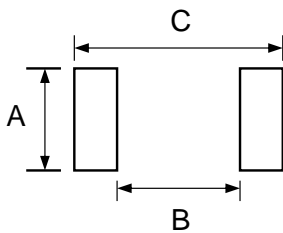

Dimensions in mm

Type	A	B	C
060618	3.5	3.7	8.4

13 Note

1. Please make sure that your product has been evaluated and confirmed against your specifications when our product is mounted to your product.
2. Don't design/ mount any components in contact with this product.
3. The moisture sensitivity level (MSL) of products is classified as level 1.
4. Shelf life: 1 years from the date of shipment.

BMRB00060618 Series Specification

14 Graph

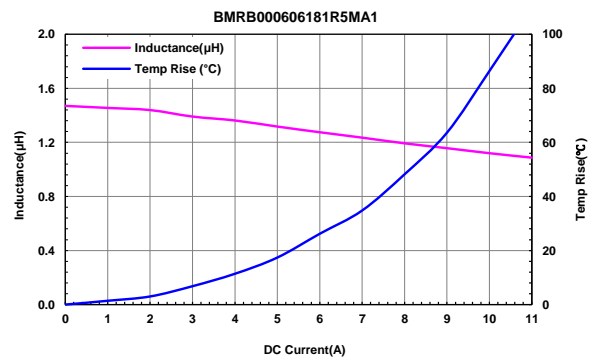
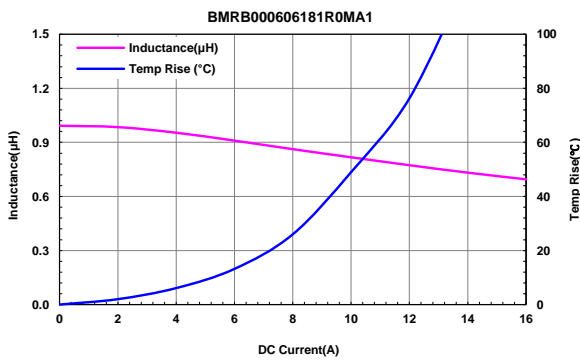
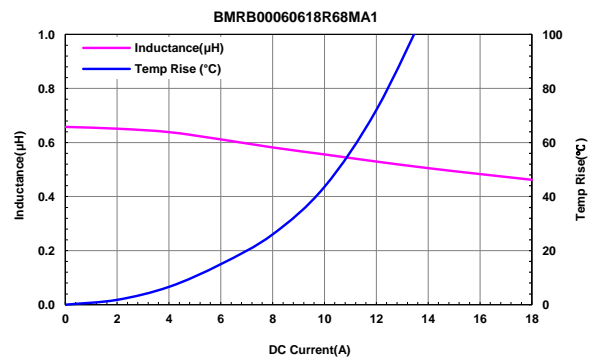
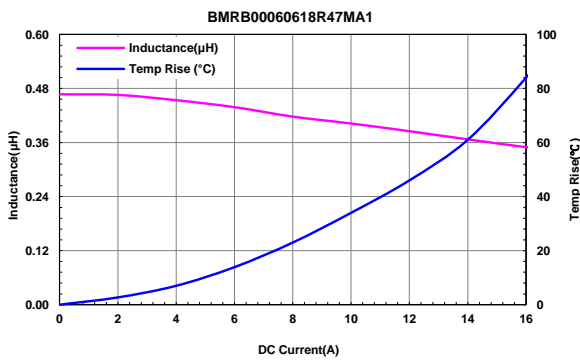
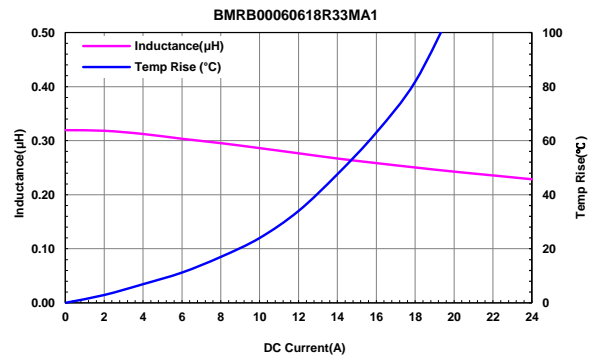
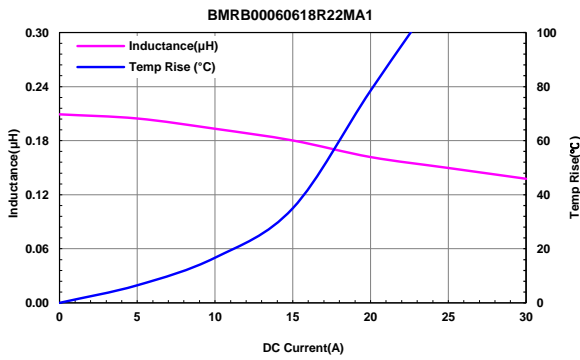

BMRB00060618 Series Specification

14 Graph

