

# Power Inductor

## BWVH Series



### Overview

BWVH series are an automatic assembly constructed power inductor, is shielded with magnetic resin and suitable for portable DC-DC converter application

### Benefits

1. Shielded with magnetic resin
2. Low profile, miniature package size and wide inductance range.
3. Low DCR and high rated current.

### Applications

1. Smartphones, tablets and wearable devices, Game consoles
2. DSC, camcorders
3. AP Routers, STBs
4. LCD TVs, monitors and panels
5. DC/DC converters

### Product Information

Series	L (mm)	W(mm)	T (mm)	Inductance (μH)
BWVH	2.0	1.6	1.02	0.16 ~ 220
	2.0	1.6	1.02	
	2.5	2.0	1.0	
	2.5	2.0	1.2	
	4.0	4.0	3.0	



## BWVH00252012 Series Specification

**1 Scope:** This specification applies to Wire Wound Power Inductors

**2 Part Numbering:**

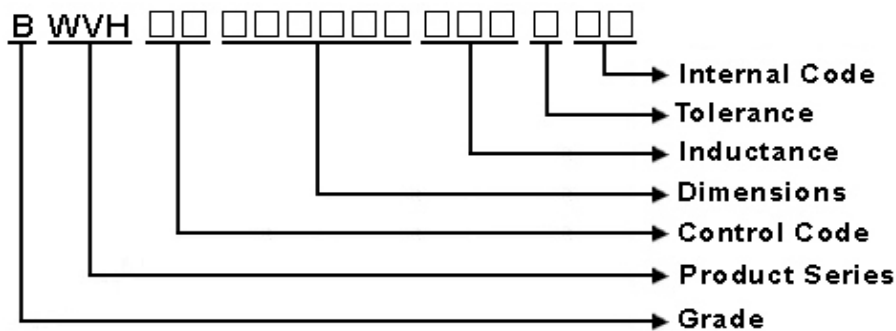

**3 Rating:**

Operating Temperature: - 5 5 °C ~ 1 2 5 °C(Including self - temperature rise)

Storage Temperature: - 4 0 °C ~ 1 0 5 °C

(The storage temperature range is for after the assembly)

**4 Marking:**

**NO Marking**

**5 Standard Testing Condition**

	Unless otherwise specified	In case of doubt
Temperature	Ordinary Temperature(15 to 35°C)	20 to 30°C
Humidity	Ordinary Humidity(25 to 85% RH)	50 to 80 %RH

## BWVH00252012 Series Specification

### 6 Configuration and Dimensions:

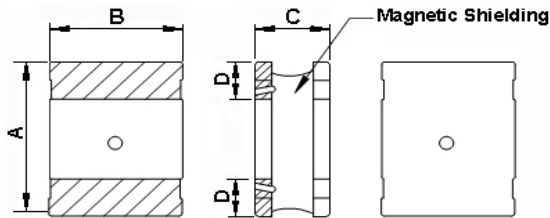

Dimensions in mm

TYPE	25 2012
A	2.5±0.25
B	2.0±0.25
C	1.2±0.05
D	0.8 typ.

Net Weight (grams)

SIZE CODE	Net Weight (grams)
252012	0.0296 (typ).

### 7 Electrical Characteristics:

Part No.	Inductance (uH)	Test Freq.	RDC (Ω)±30%	Isat(mA) Typ.(Max)	Irms(mA) Typ.(Max)	Tolerance (±%)
BWVH00252012R47□H1	0.47	1MHz,200mV	0.031	4100(3700)	3100(2600)	20,30
BWVH00252012R68□H1	0.68	1MHz,200mV	0.031	3100(2900)	3100(2600)	20,30
BWVH002520121R0□H1	1.0	1MHz,200mV	0.049	3200(3000)	3000(2500)	20,30
BWVH002520121R5□H1	1.5	1MHz,200mV	0.088	2300(2100)	2200(1800)	20,30
BWVH002520122R2□H1	2.2	1MHz,200mV	0.099	2200(2000)	2000(1700)	20,30
BWVH002520123R3□H1	3.3	1MHz,200mV	0.19	1400(1200)	1200(1000)	20,30
BWVH002520124R7□H1	4.7	1MHz,200mV	0.235	1300(1100)	1100(930)	20,30
BWVH002520126R8□H1	6.8	1MHz,200mV	0.39	1100(990)	840(710)	20,30
BWVH00252012100□H1	10	1MHz,200mV	0.51	920(820)	800(680)	20,30

**NOTE:** □-tolerance M=±20% / T=±30%

1. Operating temperature range - 5 5°C ~ 1 2 5°C (Including self - temperature rise)
2. Isat for Inductance drop 30% from its value without current.
3. I rms for a 40°C temperature rise from 25°C ambient.

## BWVH00252012 Series Specification

### 8 BWVH00252012 Series

#### 8.1 Construction:

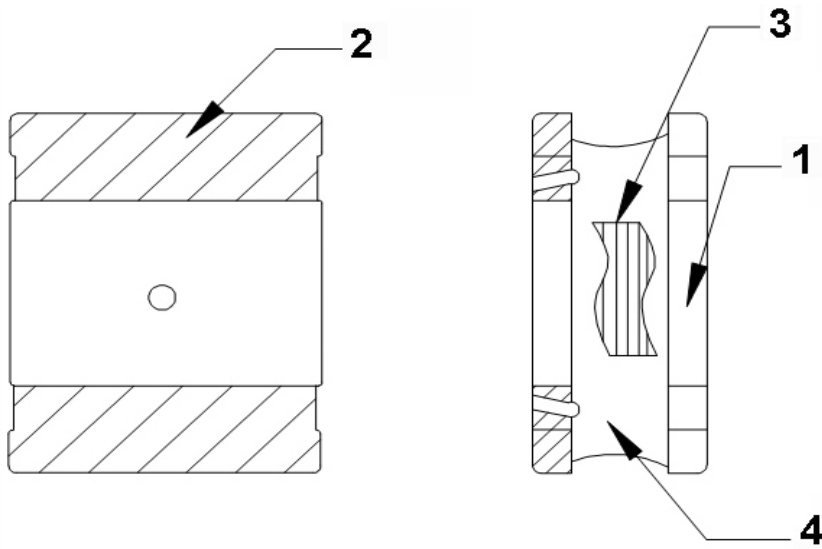

#### 8.2 Material List:

No	Part	Material
1	CORE	FERRITE
2	TERMINAL	Ag/Cu/Ni/Sn
3	WIRE	Grade 180
4	EPOXY	Magnetic powder resin

# BWVH00252012 Series Specification

## 9 Reliability Of Wire Wound Power Inductors

### 1-1.Mechanical Performance

No	Item	Specification	Test Method
1-1-1	Vibration	Chip coil shall not be damaged after tested as test method	Oscillation Frequency:10Hz to 55 Hz to 10 Hz for 1 min Total Amplitude:1.5mm Testing Time:A period of 2 hours in each of 3 mutually perpendicular directions(Total 6 hours)
1-1-2	Solderability	The wetting area of the electrode shall be at least 95% covered with new solder coating	Solder:Sn/Ag3.0/Cu0.5 per-Heating:150°C±10°C/1min to 2min solder Temperature:245°C±5°C Immersion Time:4s±1s
1-1-3	Resistance to Soldering Heat	Appearance:No damage	Solder:Sn/Ag3.0/Cu0.5 per-Heating:150°C±10°C/1min to 2min solder Temperature:260°C±5°C Immersion Time:10s±1s

### 1-2.Environmental Performance

No	Item	Specification	Test Method														
1-2-1	Heat Resistance	Appearance: No damage Inductance Change:within±10%	Temperature:125°C±3°C Time:1000hrs Then measured after exposure in the room Condition for 24h±2h														
1-2-2	Cold Resistance		Temperature: -55°C±3°C Time:1000hrs Then measured after exposure in the room Condition for 24h±2h														
1-2-3	Humidity		Temperature: 40°C±2°C Humidity:90%(RH) to 95%(RH) Time:1000hrs Then measures after exposure in the room Condition for 24h±2h														
1-2-4	Temperature Cycle		One cycle: <table border="1" style="width: 100%; border-collapse: collapse;"> <thead> <tr> <th>Step</th> <th>Temperature (°C)</th> <th>Time (min)</th> </tr> </thead> <tbody> <tr> <td>1</td> <td>-55±3</td> <td>30</td> </tr> <tr> <td>2</td> <td>25±2</td> <td>3</td> </tr> <tr> <td>3</td> <td>125±3</td> <td>30</td> </tr> <tr> <td>4</td> <td>25±2</td> <td>3</td> </tr> </tbody> </table>	Step	Temperature (°C)	Time (min)	1	-55±3	30	2	25±2	3	3	125±3	30	4	25±2
Step	Temperature (°C)	Time (min)															
1	-55±3	30															
2	25±2	3															
3	125±3	30															
4	25±2	3															
			Total: 100cycles Measured after exposure in the room condition for 24hrs														

# BWVH00252012 Series Specification

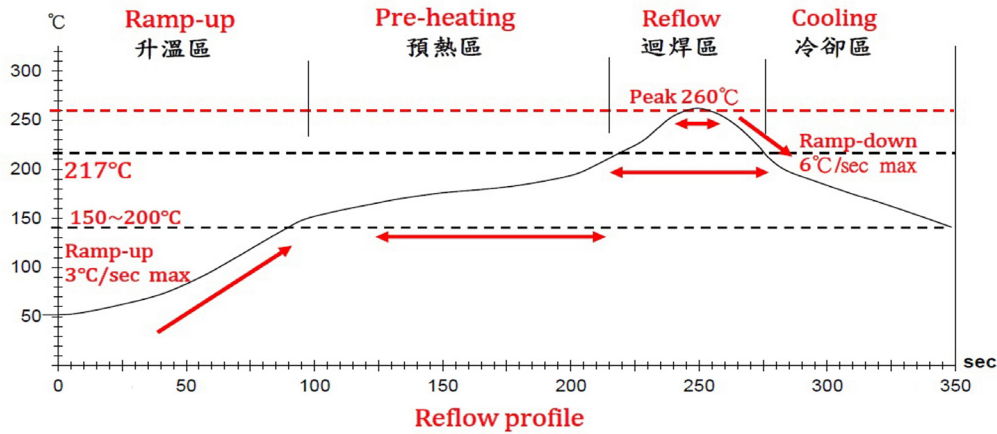

Lead-Free(LF)標準溫度分析範圍

Refer to J-STD-020C

管制項目 Item.	升温區 Ramp-up	預熱區 Pre-heating	迴焊區 Reflow	Peak Temp	冷卻區 Cooling
溫度範圍 Temp.scope	R.T ~ 150°C	150°C ~ 200°C	Above 217°C	260±5°C	Peak Temp.~150°C
標準時間 Time spec.	-	60 ~ 180 sec	60 ~ 150 sec	20 ~ 40 sec	-
實際時間 Time result	-	75 ~ 100 sec	90 ~ 120 sec	20 ~ 35 sec	-

**NOTE :**

1. Re-flow possible times : within 2 times
2. Nitrogen adopted is recommended while in re-flow
3. Products can only be soldered with reflow

## BWVH00252012 Series Specification

### 10 Packaging:

#### 10.1 Packaging -Cover tape

The force for tearing off cover tape is 10 to 100 grams in the arrow direction.

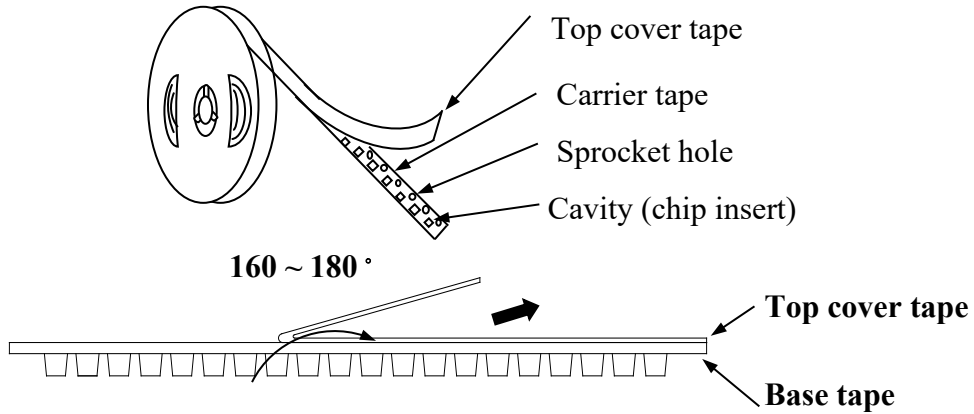

#### 10.2 Packaging Quantity

TYPE	PCS/REEL
252012	2000

#### 10.3 Reel Dimensions

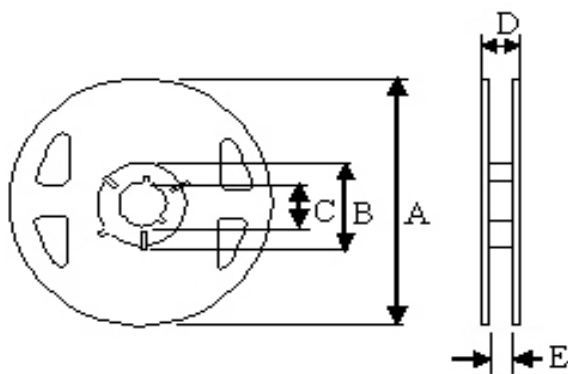

Dimensions in mm

TYPE	A	B	C	D	E
252012	180	60	13	14.4	8.4

## BWVH00252012 Series Specification

### 10 Packaging:

#### 10.4 Tape Dimensions in mm

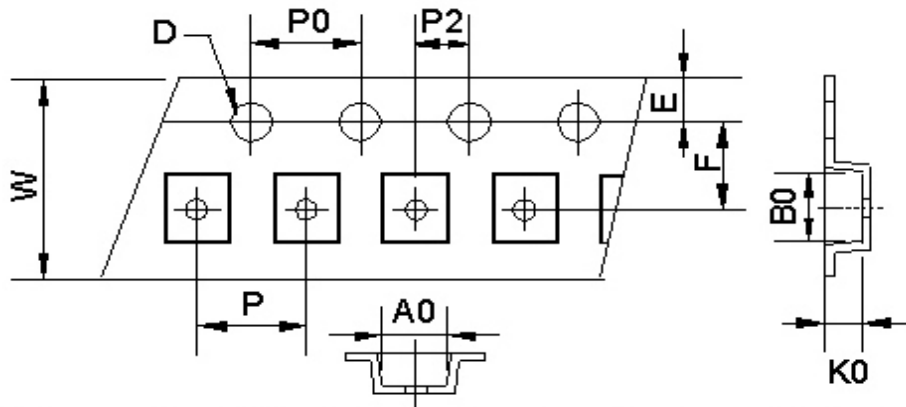

TYPE	A0	B0	K0	D	E	F	W	P	P0	P2
252012	2.4	2.75	1.35	1.55	1.75	3.5	8	4	4	2

### 11 Recommended Land Pattern:

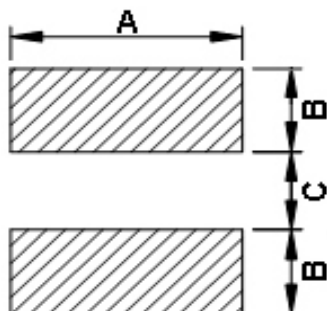

Dimensions in mm

TYPE	A	B	C
252012	2.2	0.85	0.8

### 12 Note:

- Please make sure that your product has been evaluated and confirmed against your specifications when our product is mounted to your product.
- Do not knock nor drop.
- All the items and parameters in this product specification have been prescribed on the premise that our product is used for the purpose, under the condition and in the environment agreed upon between you and us. You are requested not to use our product deviating from such agreement.
- The storage period is less than 12 months. Be sure to follow the storage conditions (Temperature: 5 to 40°C, Humidity: 10 to 75% RH or less).  
If the storage period elapses, the soldering of the terminal electrodes may deteriorate.
- Do not use or store in locations where there are conditions such as gas corrosion (salt, acid, alkali, etc.).
- The moisture sensitivity level (MSL) of products is classified as level 1.

## BWVH00252012 Series Specification

### 12 Note:

#### 7. Void Appearance tolerance Limit

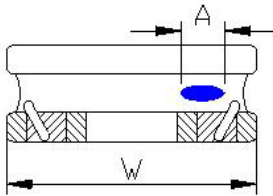

**Exposed wire tolerance limit of coating resin part on product side.**  
The unilateral should be no more than two holes.

$$A \leq W/2 \text{ GOOD}$$

$$A > W/2 \text{ NG}$$

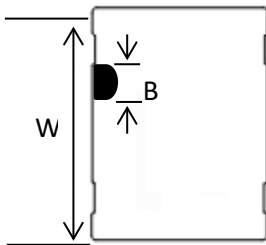

**The appearance standard of the chipping size in top side.**

$$B \leq W/5 \text{ GOOD}$$

$$B > W/5 \text{ NG}$$

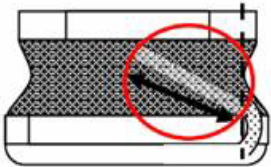

**External appearance criterion for exposed wire**

Exposed end of the winding wire at the side should be acceptable.

## BWVH00252012 Series Specification

### 13 Graph: BWVH00252012-H1 Series Graph

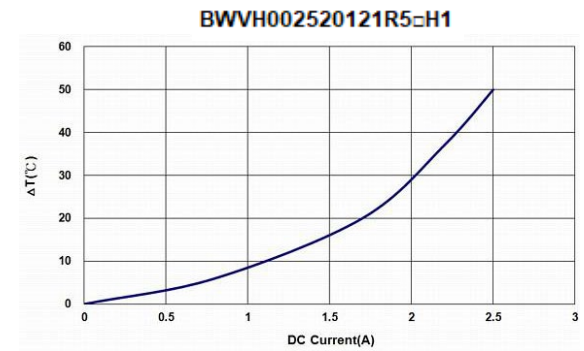
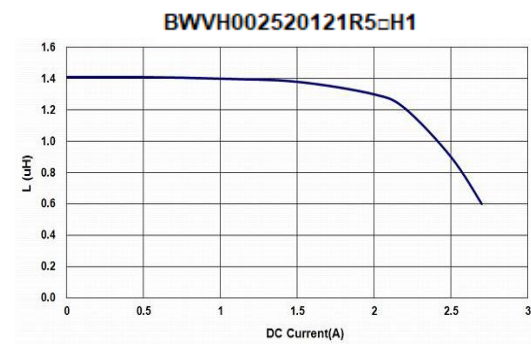
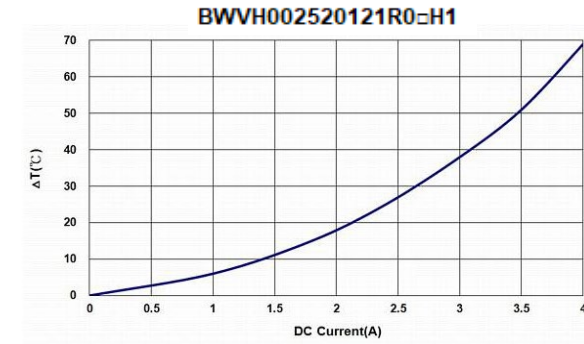
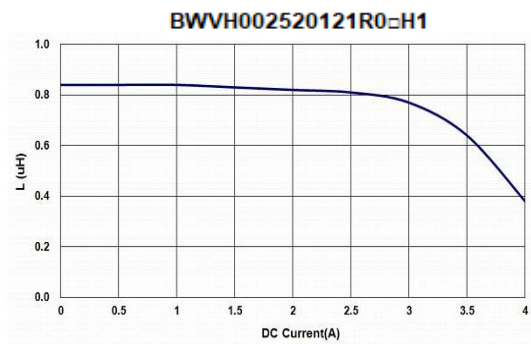
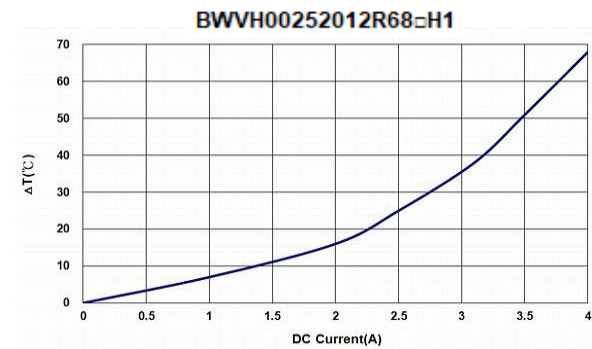
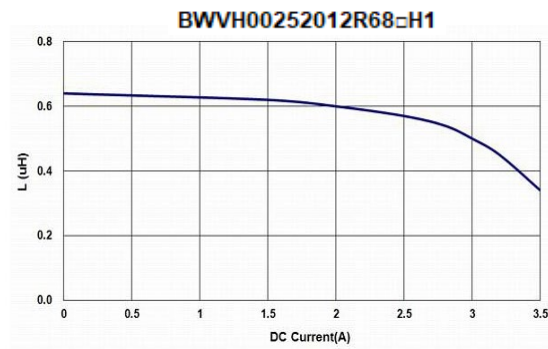
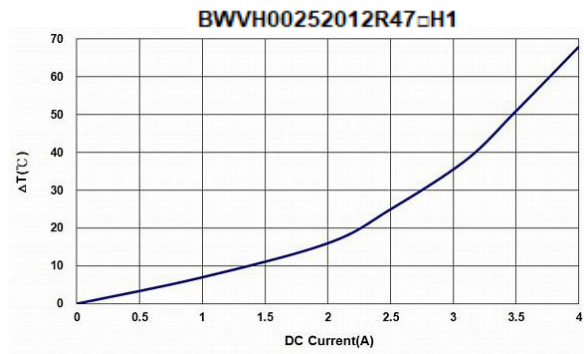
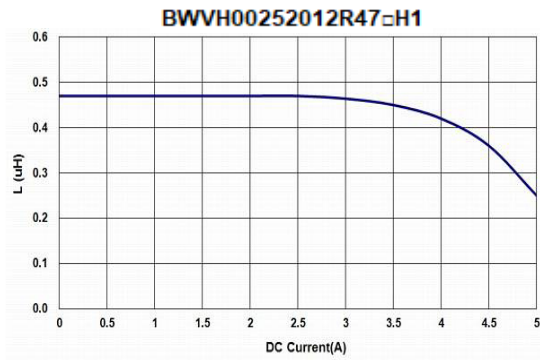

## BWVH00252012 Series Specification

**BWVH002520122R2H1**

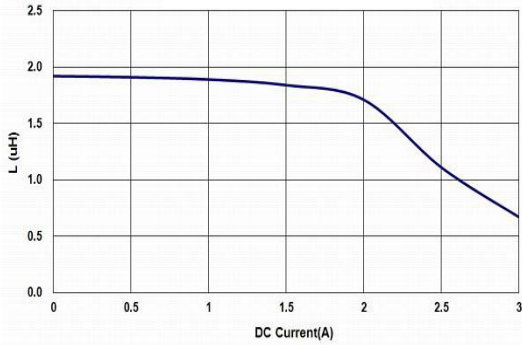

**BWVH002520122R2H1**

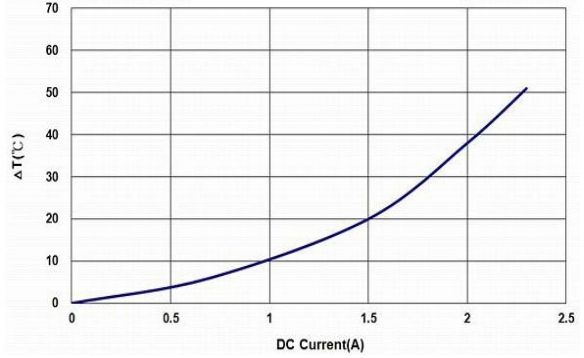

**BWVH002520123R3H1**

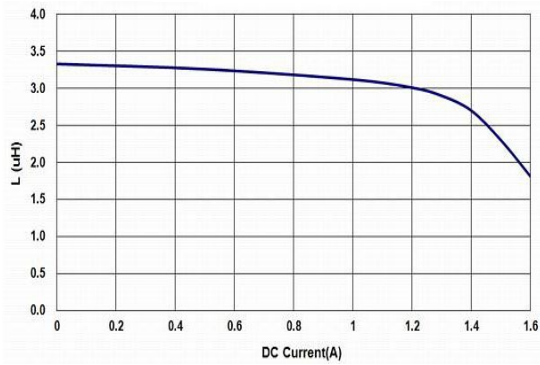

**BWVH002520123R3H1**

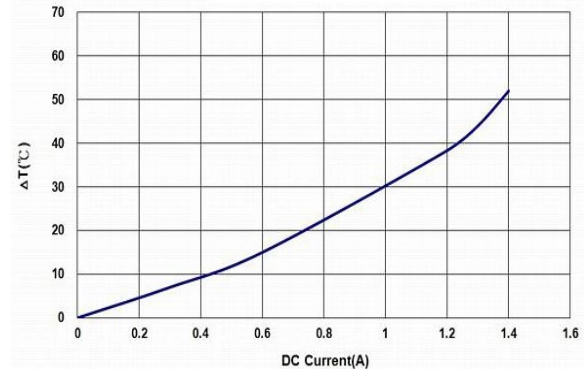

**BWVH002520124R7H1**

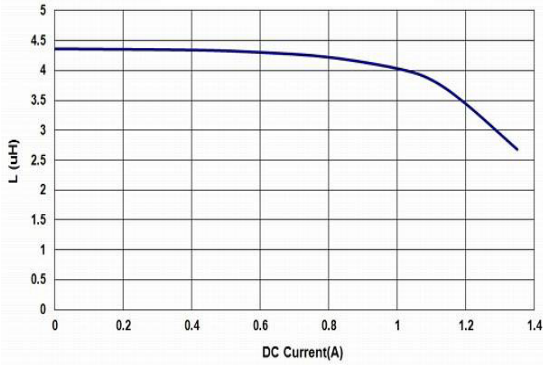

**BWVH002520124R7H1**

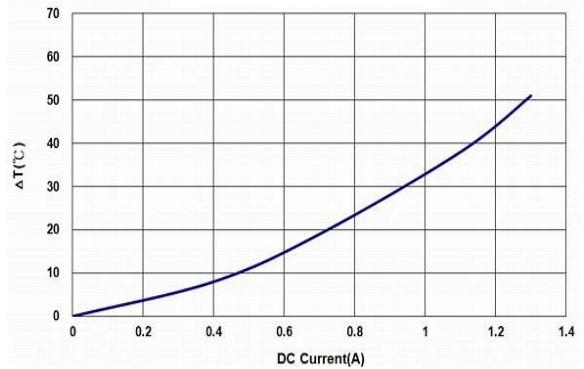

**BWVH002520126R8H1**

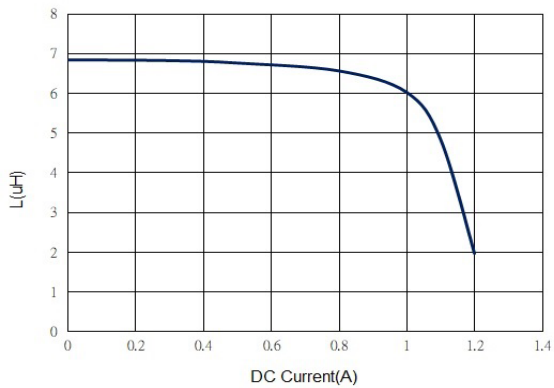

**BWVH002520126R8H1**

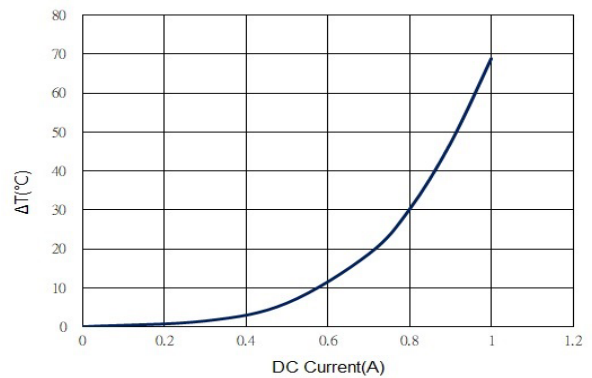

## BWVH00252012 Series Specification

