

1145HV

High voltage fast-acting brick fuse



Product features

- 11 x 5.0 x 5.0 mm surface mount package
- High voltage fast-acting brick fuse
- 500 Vdc voltage rating
- Ceramic tube, silver plated cap construction
- Moisture sensitivity level (MSL): 1

Applications

Primary and secondary circuit protection:

- Server & telecom systems, including 380 Vdc distribution
- Single phase and 3-phase UPS
- 380 Vdc DC-DC converters
- High voltage DC-DC conversion
- Power factor correction
- Capacitor output protection

Agency information

cURus Recognition file number:
E19180, Guide JDYX2



Environmental compliance



Ordering part number

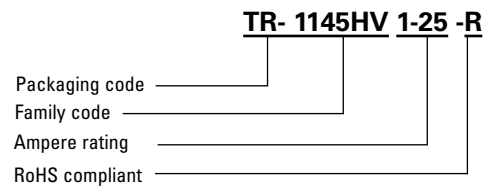

Packaging prefix

TR- (1000 parts on a 13" diameter tape and reel)



Powering Business Worldwide

Electrical characteristics

Amp Rating	125% In minimum	200% In maximum	1000% In maximum
1 A ~ 5 A	1 hour	120 seconds	1 second

Product specifications

Part number	Current rating (A)	Voltage rating		Interrupting rating @ rated voltage ¹		Typical resistance ² (mΩ)	Typical voltage drop (mV)	Typical pre-arcing ³ I ² t (A ² s)	Part marking
		(Vac)	(Vdc)	(A) Vac	(A) Vdc				
1145HV1-R	1	350	500 350	100	100 A @ 500 Vdc 1500 A @ 350 Vdc	200	220	0.50	1
1145HV1-25-R	1.25	350	500 350	100	100 A @ 500 Vdc 1500 A @ 350 Vdc	160	210	0.95	1.25
1145HV1-6-R	1.6	350	500 350	100	100 A @ 500 Vdc 1500 A @ 350 Vdc	100	190	2.3	1.6
1145HV2-R	2	350	500 350	100	100 A @ 500 Vdc 1500 A @ 350 Vdc	80	185	4.1	2
1145HV2-5-R	2.5	350	500 350	100	100 A @ 500 Vdc 1500 A @ 350 Vdc	40	120	2.6	2.5
1145HV3-15-R	3.15	350	500 350	100	100 A @ 500 Vdc 1500 A @ 350 Vdc	31.5	140	3.3	3.15
1145HV4-R	4	350	450 125	100	100 A @ 450 Vdc 1500 A @ 125 Vdc	24.5	140	5.5	4
1145HV5-R	5	350	450 125	100	100 A @ 450 Vdc 1500 A @ 125 Vdc	17.5	130	11.5	5

1. AC Interrupting rating (measured at designated voltage, 100% power factor); DC Interrupting rating (measured at designated voltage, time constant of less than 50 microseconds, battery source)
 2. DC Cold resistance are measured at <10% of rated current in ambient temperature of +25 °C
 3. Typical pre-arcing I²t are measured at 10 In current, DC battery bank

Dimensions- mm

Drawing not to scale

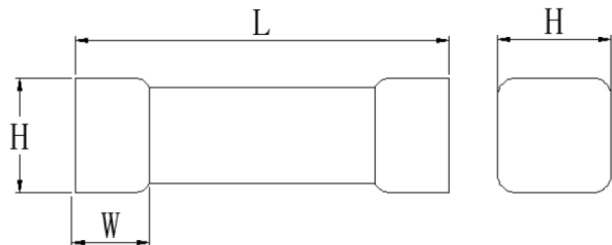

Rating	L	W	H
1 A ~ 5 A	11.2 ± 0.50	2.8 ± 0.50	5.05 ± 0.50

Recommended pad layout

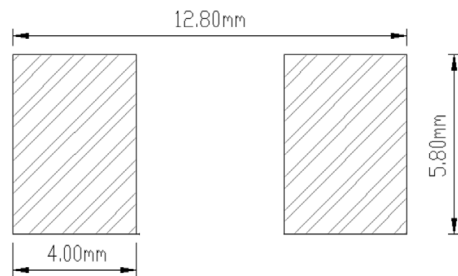

Recommended trace thickness is 35 μm;
 the minimum trace width is 5 mm
 Recommended stencil thickness is 0.15 mm

1145HV is also compatible with Littelfuse LF885 pad layout; pad size 7.23 mm x 5.26 mm

General specifications

Operating temperature: -40 °C to +125 °C with proper derating factor applied
Thermal shock: MIL-STD-202, Method 107G -40 °C/+125 °C. Note: Number of cycles required 100 times
Mechanical shock: Figure 1 of Method 213. Condition C, 100 g, 6 ms
Mechanical vibration: MIL-STD-202G, Method 204, 5 g's for 20 minutes, 12 cycles each of 3 orientations. Test from 10-2000 Hz
Resistance to solder heat: MIL-STD-202G Method 210F, condition D (+260 °C, 10 s)
Solderability test: J-STD-002, Method B1 Steam aging 1 hour, Solder temperature +255 ± 5 °C, solder immersion time 5 s

Packaging information - mm

1000 parts per 13" diameter reel (EIA-481 compliant)
Drawing not to scale

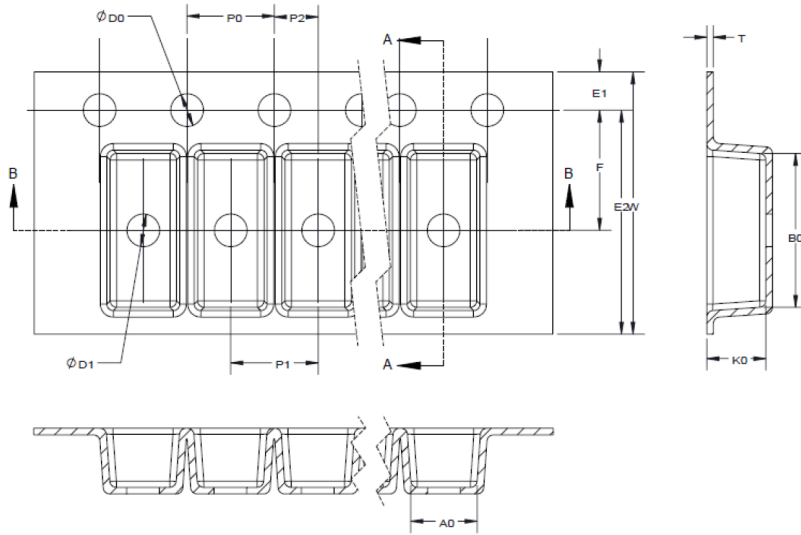

Dimension	millimeter
W	24.00
F	11.50
E1	1.75
E2	N/A
P0	4.00
P1	8.00
P2	2.00
D0	1.50
D1	1.50
A0	4.85
B0	12.75
K0	4.90
T	0.40

Reel dimension- mm

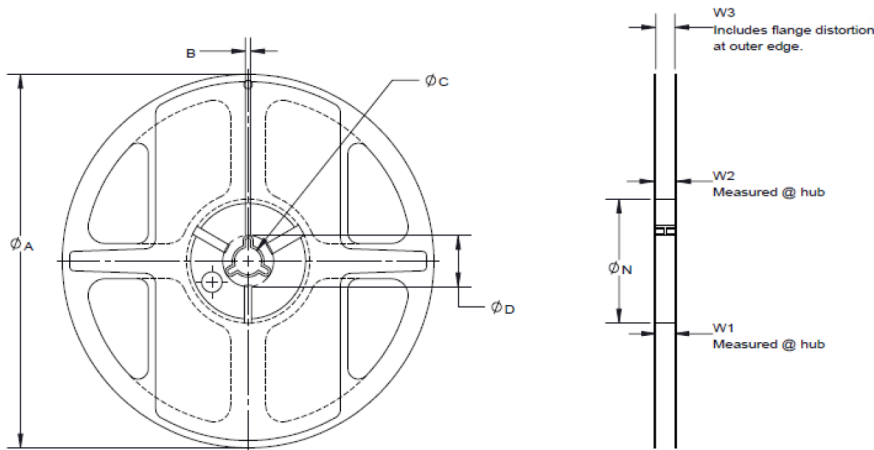

Dimension	millimeter
A	330 ± 1
B	2.5 ± 0.2
C	13.5 ± 0.2
D	N/A
N	100 ± 0.5
W1	24.8 ± 0.5
W2	30.4 max
W3	N/A

Temperature derating curve

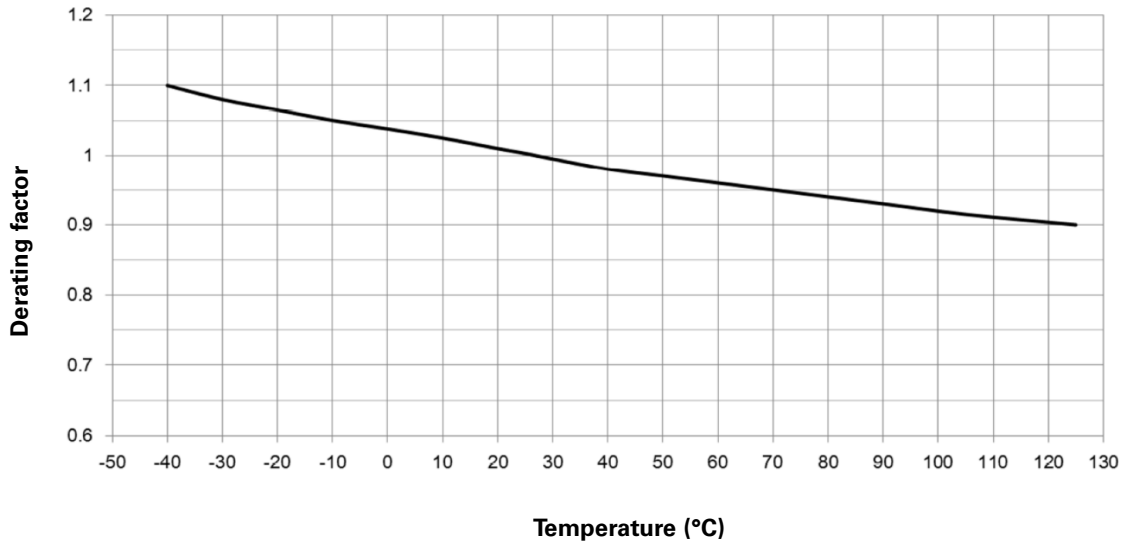

Current vs. time curve

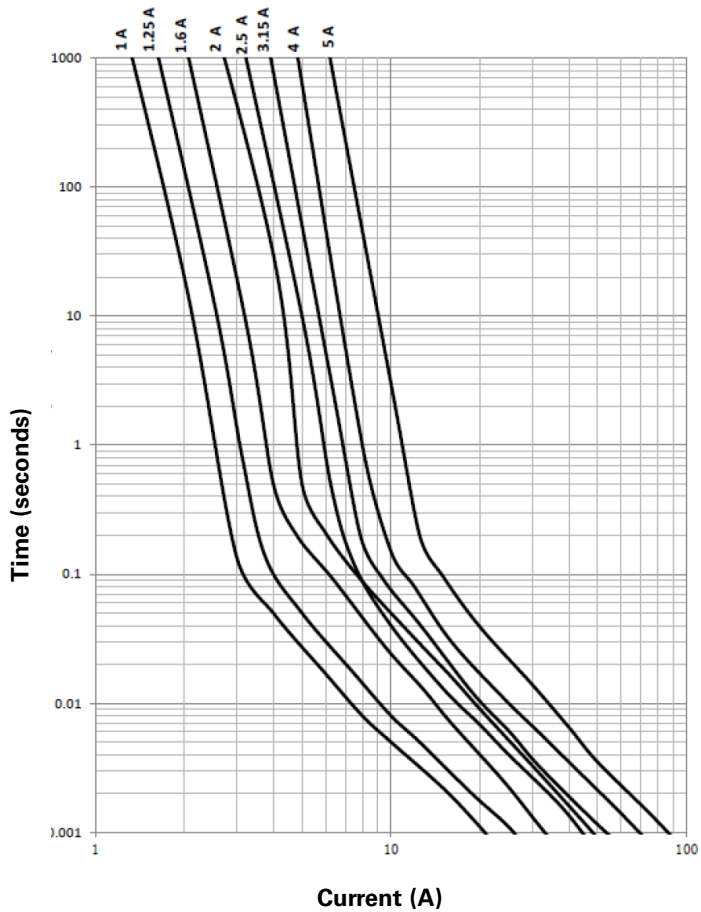

I²t vs. time curve

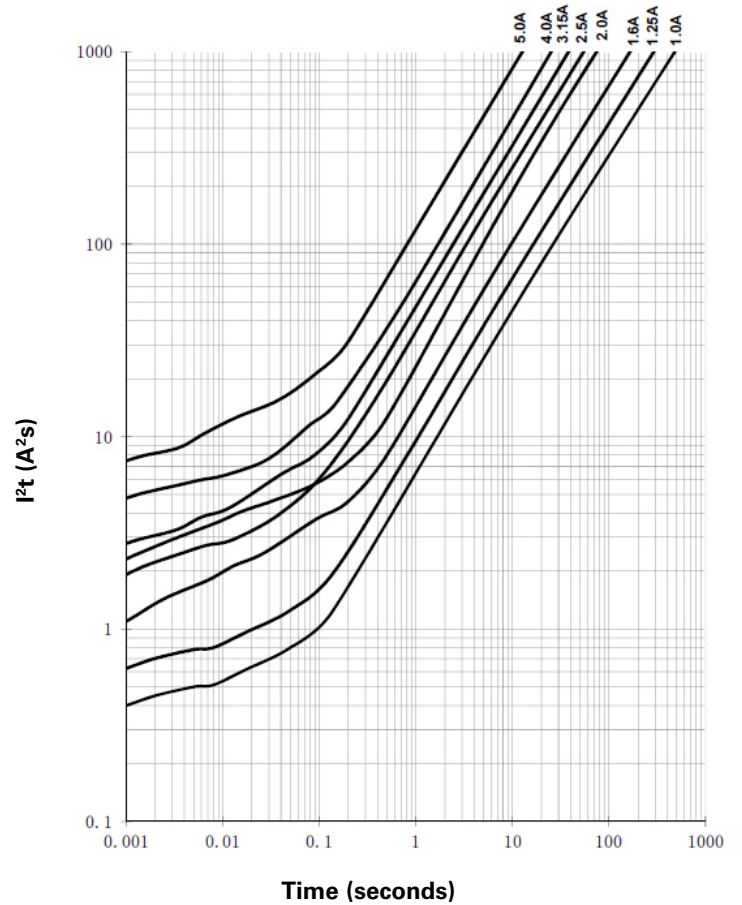

Solder reflow profile

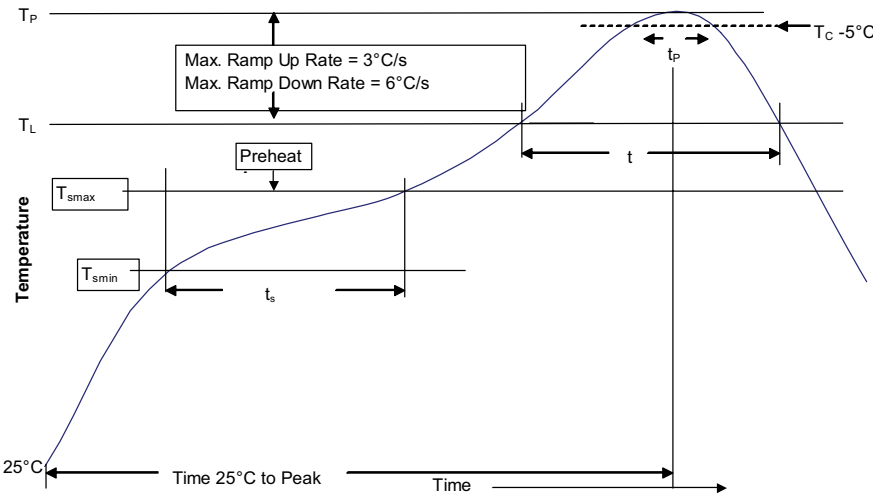

Table 1 - Standard SnPb solder (T_C)

Package thickness	Volume mm ³ <350	Volume mm ³ ≥350
<2.5 mm	235 °C	220 °C
≥2.5 mm	220 °C	220 °C

Table 2 - Lead (Pb) free solder (T_C)

Package thickness	Volume mm ³ <350	Volume mm ³ 350 - 2000	Volume mm ³ >2000
<1.6 mm	260 °C	260 °C	260 °C
1.6 – 2.5 mm	260 °C	250 °C	245 °C
>2.5 mm	250 °C	245 °C	245 °C

Reference J-STD-020

Profile feature	Standard SnPb solder	Lead (Pb) free solder
Preheat and soak	<ul style="list-style-type: none"> Temperature min. (T_{smin}) Temperature max. (T_{smax}) Time (T_{smin} to T_{smax}) (t_s) 	<ul style="list-style-type: none"> 100 °C 150 °C 60-120 seconds
Ramp up rate T _L to T _p	3 °C/ second max.	3 °C/ second max.
Liquidous temperature (T _L)	183 °C	217 °C
Time (t _L) maintained above T _L	60-150 seconds	60-150 seconds
Peak package body temperature (T _p)*	Table 1	Table 2
Time (t _p)* within 5 °C of the specified classification temperature (T _C)	20 seconds*	30 seconds*
Ramp-down rate (T _p to T _L)	6 °C/ second max.	6 °C/ second max.
Time 25 °C to peak temperature	6 minutes max.	8 minutes max.

* Tolerance for peak profile temperature (T_p) is defined as a supplier minimum and a user maximum.

Life Support Policy: Eaton does not authorize the use of any of its products for use in life support devices or systems without the express written approval of an officer of the Company. Life support systems are devices which support or sustain life, and whose failure to perform, when properly used in accordance with instructions for use provided in the labeling, can be reasonably expected to result in significant injury to the user.

Eaton reserves the right, without notice, to change design or construction of any products and to discontinue or limit distribution of any products. Eaton also reserves the right to change or update, without notice, any technical information contained in this bulletin.

Eaton
Electronics Division
1000 Eaton Boulevard
Cleveland, OH 44122
United States
Eaton.com/electronics

© 2021 Eaton
All Rights Reserved
Printed in USA
Publication No. ELX1039 BU-ELX21039
May 2021

Eaton is a registered trademark.
All other trademarks are property of their respective owners.

Follow us on social media to get the latest product and support information.

