

RELAY BASES

Compact 8-11 Pin Commercial Relay Bases

- DIN rail (EN50022) or chassis screw mounting
- Screw driver release DIN clip
- Rising saddle terminals for ease of wire insertion
- Accepts fork, ferule and ring terminals (ring non IP20 only)
- 2 x 2.5mm² cable acceptance
- 2x1.5mm² bootlace crimp
- IP20 finger protection types
- Relay retaining clip accessory
- Tubular contacts for reliability
- Terminal numbering to DIN 46199
- G rail adaptor available
-  CE approved

CS113A



CS083AN



SPECIFICATION

Rating	10A/250VAC
Dielectric Strength	>2kV
Working temperature	-25°C to 55°C
Insulation resistance	1,000MΩ/500VDC
Moulding	UL94-V0 PA66
Contacts	Phosphor bronze, tin-plated <3µm
Screws	Low carbon steel, lower layer copper plating <2µm, surface layer nickel plating <3µm
Terminal Screw torque	0.7Nm max
Insertion Force	100N max

TYPE NO. DESCRIPTION

CS083A	8-pin open
CS083AN	8-pin IP20 finger protection
CS113A	11-pin open
CS113AN	11-pin IP20 finger protection
CSC03	Retaining Clip

CSC03

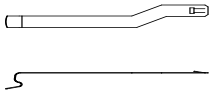

Supplied in pairs
Fits 50mm relay height

CS083A

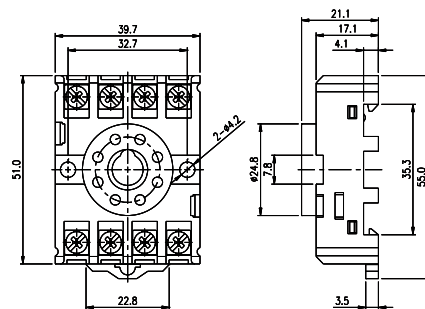

CS113A

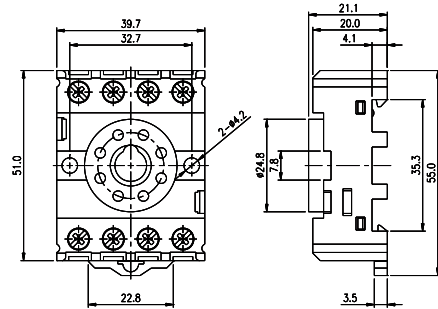

CS113A-

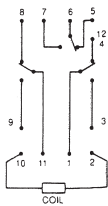

CS083AN

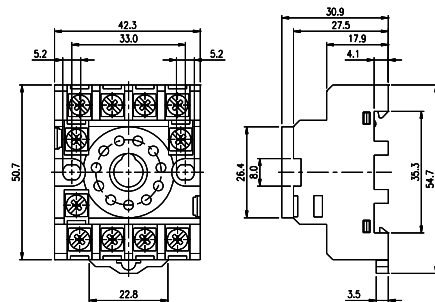

CS113AN

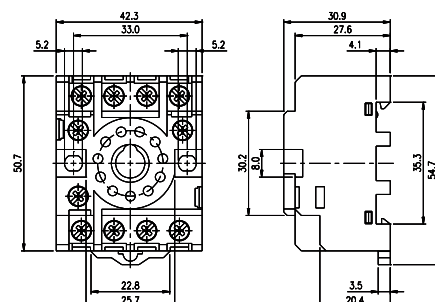

CS083A-

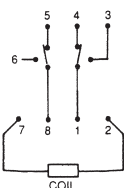

+44 (0)1638 716101
info@camdenboss.com
www.camdenboss.com

We operate a constant improvement policy,
our products are subject to change without notice.