

15KPE

15000 W Transient voltage suppressor

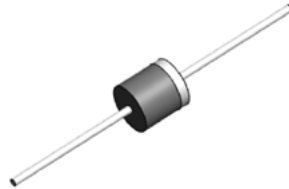

Product features

- Low incremental surge resistance
- Excellent clamping capability
- 15,000 W peak pulse power capability at 10/1000 μ s waveform
- Typical I_r less than 2 μ A above 30 V
- Fast response time: typically less than 1.0 ps from 0 V to V_{BR} minimum
- High temperature reflow and wave soldering
- Plastic package meets UL 94 V-0 flammability rating
- Terminal: Solder plated leads, solderable per J-STD-02
- UL 497B recognized.
File No. : E198449 Guide QVGQ2

Applications

- Consumer electronics
- Telecommunications
- Computing and servers
- Appliances
- Industrial automation
- Mobile and wearables

Environmental compliance and general specifications



Ordering part number

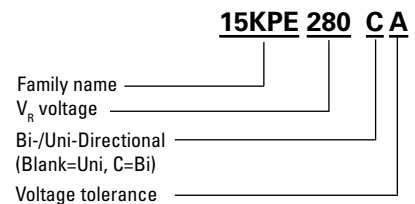

PIN configuration

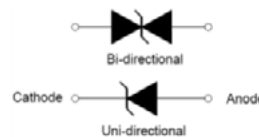
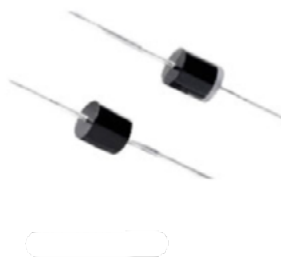

Symbol



Powering Business Worldwide

Absolute maximum ratings

(+25 °C, RH=45%-75%, unless otherwise noted)

Parameter	Symbol	Value	Unit
Storage operating junction temperature range	T_{STG}/T_J	-55 to +175	°C
Steady state power dissipation at $T_L = +75$ °C	$P_{M(AV)}$	8.0	W
Peak pulse power dissipation on 10/1000 μ s waveform	P_{PP}	15,000	W
Peak forward surge current, 8.3 ms single half sine-wave for unidirectional only	I_{FSM}	400	A
Typical thermal resistance junction to lead	$R_{\theta JL}$	8.0	°C/W
Typical thermal resistance junction to ambient	$R_{\theta JA}$	40	°C/W

Mechanical parameters- mm

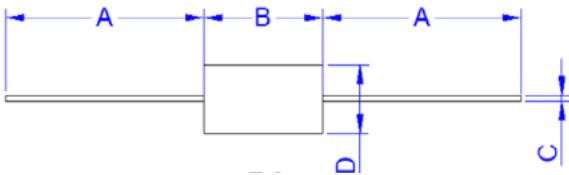

Dimension	Millimeters		Inches	
	Minimum	Maximum	Minimum	Maximum
A	25.40		1.000	
B	8.60	9.40	0.339	0.370
C	1.20	1.40	0.047	0.055
D	8.60	9.10	0.339	0.358

Part marking

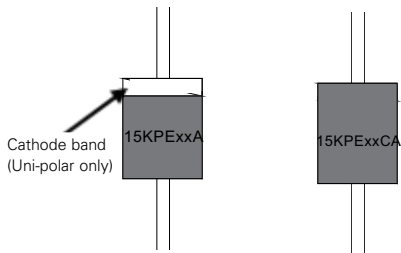

Packaging information (mm)

300 parts per box.

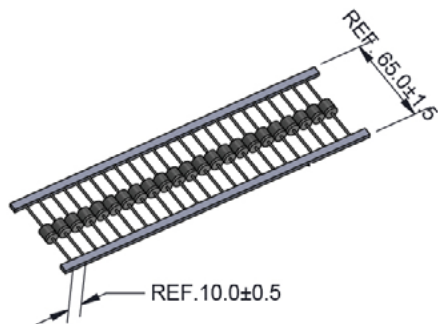

Electrical characteristics (+25 °C)

Part number		V_R (V)	$I_R @ V_R$ (μ A)	$V_{BR} @ I_T$ min (V)	max (V)	I_T (mA)	$V_C @ I_{PP}$ max (V)	I_{PP} (A)
Uni-polar	Bi-polar							
15KPE17A	15KPE17CA	17	5000	18.9	20.9	50	29.3	515.4
15KPE18A	15KPE18CA	18	5000	20	22.1	50	30.9	488.7
15KPE20A	15KPE20CA	20	1500	22.2	24.5	20	34.3	440.2
15KPE22A	15KPE22CA	22	500	24.4	26.9	10	37.1	407
15KPE24A	15KPE24CA	24	150	26.7	29.5	5	40.7	371
15KPE26A	15KPE26CA	26	50	28.9	31.9	5	44	343.2
15KPE28A	15KPE28CA	28	25	31.1	34.4	5	47.5	317.9
15KPE30A	15KPE30CA	30	15	33.3	36.8	5	50.7	297.8
15KPE33A	15KPE33CA	33	2	36.7	40.6	5	54.7	276.1
15KPE36A	15KPE36CA	36	2	40	44.2	5	59.8	252.5
15KPE40A	15KPE40CA	40	2	44.4	49.1	5	65.8	229.5
15KPE43A	15KPE43CA	43	2	47.8	52.8	5	69.8	216.3
15KPE45A	15KPE45CA	45	2	50	55.3	5	72.8	207.4
15KPE48A	15KPE48CA	48	2	53.3	58.9	5	77.7	194.3
15KPE51A	15KPE51CA	51	2	56.7	62.7	5	82.9	182.1
15KPE54A	15KPE54CA	54	2	60	66.3	5	87.7	172.2
15KPE58A	15KPE58CA	58	2	64.4	71.2	5	93.8	161
15KPE60A	15KPE60CA	60	2	66.7	73.7	5	97.4	155
15KPE64A	15KPE64CA	64	2	71.1	78.6	5	104.2	144.9
15KPE70A	15KPE70CA	70	2	77.8	86	5	113.6	132.9
15KPE75A	15KPE75CA	75	2	83.3	92.1	5	122	123.8
15KPE78A	15KPE78CA	78	2	86.7	95.8	5	126.1	119.7
15KPE85A	15KPE85CA	85	2	94.4	104	5	137.6	109.7
15KPE90A	15KPE90CA	90	2	100	111	5	145.6	103.7
15KPE100A	15KPE100CA	100	2	111	123	5	161.3	93.6
15KPE110A	15KPE110CA	110	2	122	135	5	178.6	84.5
15KPE120A	15KPE120CA	120	2	133	147	5	192.3	78.5
15KPE130A	15KPE130CA	130	2	144	159	5	208.3	72.5
15KPE150A	15KPE150CA	150	2	167	185	5	241.9	62.4
15KPE160A	15KPE160CA	160	2	178	197	5	258.6	58.4
15KPE170A	15KPE170CA	170	2	189	209	5	272.7	55.4
15KPE180A	15KPE180CA	180	2	201	222	5	288.5	52.3
15KPE200A	15KPE200CA	200	2	224	247	5	319.1	47.3
15KPE220A	15KPE220CA	220	2	246	272	5	352.5	42.8
15KPE240A	15KPE240CA	240	2	268	292	5	384.6	39.3
15KPE260A	15KPE260CA	260	2	289	317	5	416.7	36.2
15KPE280A	15KPE280CA	280	2	311	341	5	454.5	33.2

Ratings and V-I characteristic curves (+25 °C unless otherwise noted)

V- I curve characteristics (Uni-directional)

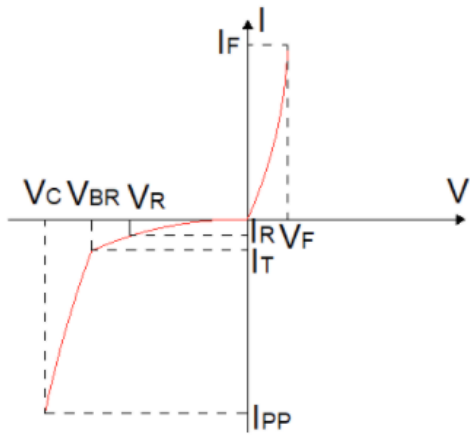

V- I curve characteristics (Bi-directional)

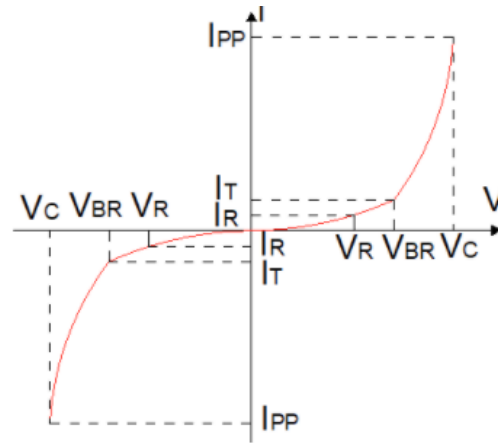

Surge waveform: 10/1000 μ s

V_R : Stand-off voltage – Maximum voltage that can be applied

V_{BR} : Breakdown voltage

V_C : Clamping voltage – Peak voltage measured across the suppressor at a specified I_{PP}

I_R : Reverse leakage current

I_T : Test current

V_F : Forward voltage drop for Uni-directional TVS diode

Pulse waveform

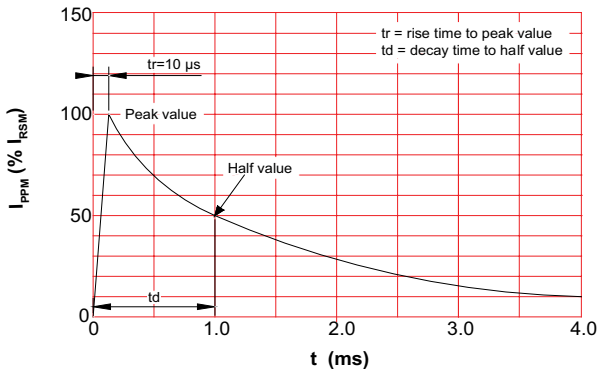

Pulse derating curve

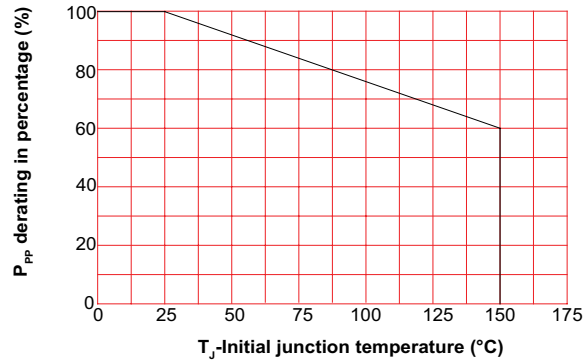

Peak pulse power dissipation vs. pulse width

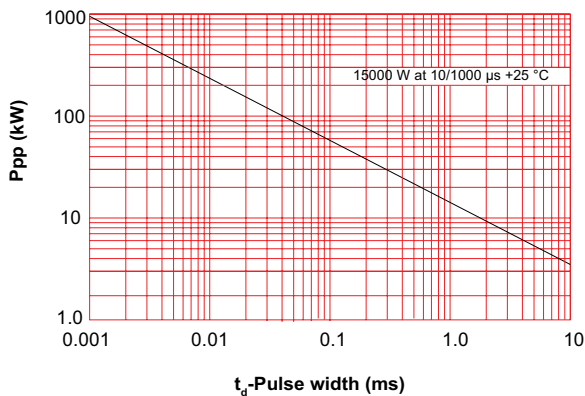

Solder reflow profile

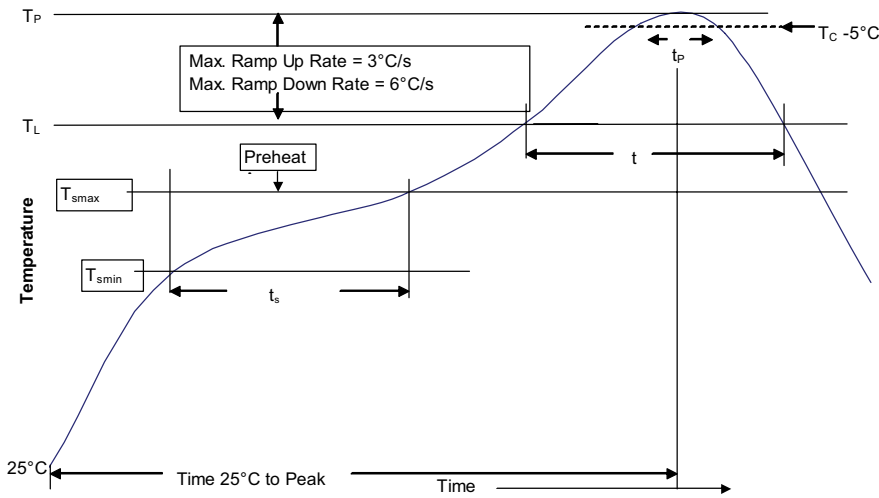

Table 1 - Standard SnPb solder (T_C)

Package thickness	Volume mm ³ <350	Volume mm ³ ≥350
<2.5 mm	235 °C	220 °C
≥2.5 mm	220 °C	220 °C

Table 2 - Lead (Pb) free solder (T_C)

Package thickness	Volume mm ³ <350	Volume mm ³ 350 - 2000	Volume mm ³ >2000
<1.6 mm	260 °C	260 °C	260 °C
1.6 – 2.5 mm	260 °C	250 °C	245 °C
>2.5 mm	250 °C	245 °C	245 °C

Reference J-STD-020

Profile feature	Standard SnPb solder	Lead (Pb) free solder
Preheat and soak		
• Temperature min. (T_{smin})	100 °C	150 °C
• Temperature max. (T_{smax})	150 °C	200 °C
• Time (T_{smin} to T_{smax}) (t_s)	60-120 seconds	60-180 seconds
Ramp up rate T_L to T_p	3 °C/ second max.	3 °C/ second max.
Liquidous temperature (T_L)	183 °C	217 °C
Time (t_L) maintained above T_L	60-150 seconds	60-150 seconds
Peak package body temperature (T_p)*	Table 1	Table 2
Time (t_p)* within 5 °C of the specified classification temperature (T_C)	20 seconds*	40 seconds*
Ramp-down rate (T_p to T_L)	6 °C/ second max.	6 °C/ second max.
Time 25 °C to peak temperature	6 minutes max.	8 minutes max.

* Tolerance for peak profile temperature (T_p) is defined as a supplier minimum and a user maximum.

Wave solder profile

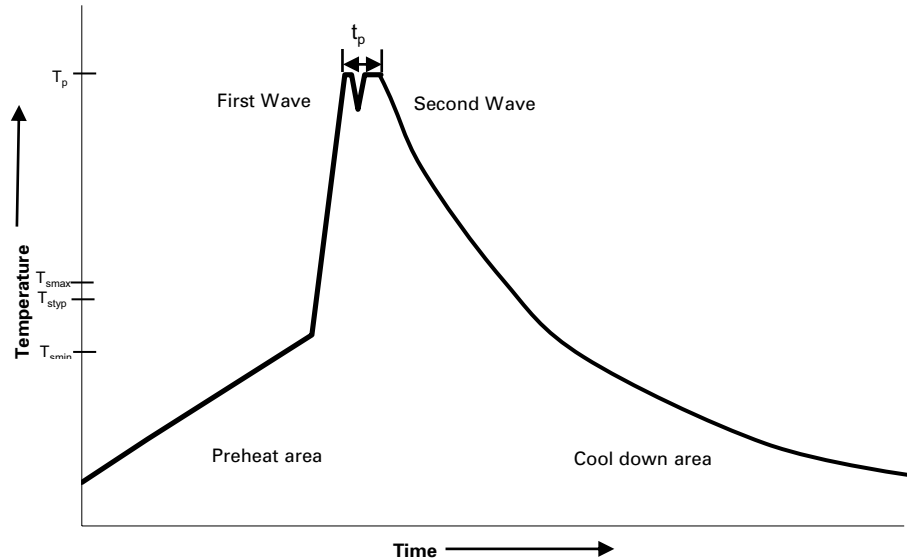

Reference EN 61760-1:2006

Profile feature	Standard SnPb solder	Lead (Pb) free solder
Preheat		
• Temperature min. (T_{smin})	100 °C	100 °C
• Temperature typ. (T_{styp})	120 °C	120 °C
• Temperature max. (T_{smax})	130 °C	130 °C
• Time (T_{smin} to T_{smax}) (t_s)	70 seconds	70 seconds
Δ preheat to max Temperature	150 °C max.	150 °C max.
Peak temperature (T_p)*	235 °C – 260 °C	250 °C – 265 °C
Time at peak temperature (t_p)	10 seconds max 5 seconds max each wave	10 seconds max 5 seconds max each wave
Ramp-down rate	~ 2 K/s min ~3.5 K/s typ ~5 K/s max	~ 2 K/s min ~3.5 K/s typ ~5 K/s max
Time 25 °C to 25 °C	4 minutes	4 minutes

Manual solder

+350 °C (4-5 seconds by soldering iron), generally manual/hand soldering is not recommended.

Life Support Policy: Eaton does not authorize the use of any of its products for use in life support devices or systems without the express written approval of an officer of the Company. Life support systems are devices which support or sustain life, and whose failure to perform, when properly used in accordance with instructions for use provided in the labeling, can be reasonably expected to result in significant injury to the user.

Eaton reserves the right, without notice, to change design or construction of any products and to discontinue or limit distribution of any products. Eaton also reserves the right to change or update, without notice, any technical information contained in this bulletin.

Eaton
Electronics Division
1000 Eaton Boulevard
Cleveland, OH 44122
United States
Eaton.com/electronics

© 2020 Eaton
All Rights Reserved
Printed in USA
Publication No. 11207 BU-MC20185
November 2020

Eaton is a registered trademark.

All other trademarks are property of their respective owners.

Follow us on social media to get the latest product and support information.

