

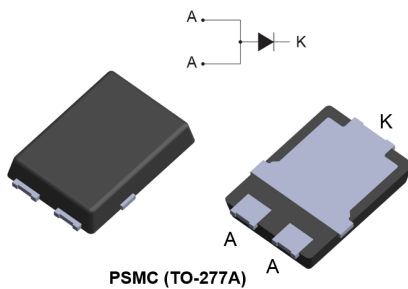

Automotive 100 V - 10 A power Schottky trench diode



Features

- AEC-Q101 qualified 
- PPAP capable
- ST trench process
- High junction temperature capability
- Low forward voltage drop
- Low recovery charges
- Reduces conduction, reverse and switching losses
- Flat package
- ECOPACK2 compliant

Applications

- DC/DC converter
- Auxiliary power supply
- High switching frequency converter
- Flyback topology
- Freewheeling function
- Secondary rectification

Description

This 10 A, 100 V rectifier is based on ST trench technology that achieves the best in class V_F/I_R trade-off for a given silicon surface.

Integrated in flat packages, this STPST10H100-Y trench device is intended to be used in high frequency miniature switched mode power supplies such as adaptors. It is also an ideal candidate for auxiliary power supply in telecom, server, lighting or smart metering and can be the perfect companion device to our VIPer products.



Product status link

[STPST10H100-Y](#)

Product summary

$I_{F(AV)}$	10 A
V_{RRM}	100 V
T_j (max.)	175 °C
V_F (typ.)	0.565 V

1 Characteristics

Table 1. Absolute ratings (limiting values at 25 °C, unless otherwise specified, with 2 anode terminals short-circuited)

Symbol	Parameter	Value	Unit	
V _{RRM}	Repetitive peak reverse voltage (T _j = -40°C to + 175°C)	100	V	
I _{F(AV)}	Average forward current, δ = 0.5 square wave	T _c = 155 °C ⁽¹⁾	10	A
I _{FSM}	Surge non repetitive forward current	t _p = 10 ms sinusoidal	235	A
T _{stg}	Storage temperature range	-65 to +175	°C	
T _j	Maximum operating junction temperature range ⁽²⁾	-40 to +175	°C	

1. Value based on R_{th(j-c)}(max.).

2. (dP_{tot}/dT_j) < (1/R_{th(j-a)}) condition to avoid thermal runaway for a diode on its own heatsink.

Table 2. Thermal resistance parameter

Symbol	Parameter	Typ. value	Unit
R _{th(j-c)}	Junction to case PSMC (TO-277)	1.25	°C/W

For more information, please refer to the following application note:

- AN5088: Rectifiers thermal management, handling and mounting recommendations

Table 3. Static electrical characteristics

Symbol	Parameter	Test conditions		Min.	Typ.	Max.	Unit
I _R ⁽¹⁾	Reverse leakage current	T _j = 125 °C	V _R = 70 V	-	2	6.4	mA
		T _j = 25 °C	V _R = 100 V	-		26	μA
		T _j = 125 °C		-	4	13.5	mA
V _F ⁽²⁾	Forward voltage drop	T _j = 25 °C	I _F = 5 A	-	0.535	0.590	V
		T _j = 125 °C		-	0.460	0.520	
		T _j = 25 °C	I _F = 10 A	-	0.635	0.700	
		T _j = 125 °C		-	0.565	0.620	

1. Pulse test: t_p = 5 ms, δ < 2%

2. Pulse test: t_p = 380 μs, δ < 2%

To evaluate the conduction losses, use the following equation:

$$P = 0.42 \times I_{F(AV)} + 0.020 \times I_{F(RMS)}^2$$

For more information, please refer to the following application notes related to the power losses :

- AN604: Calculation of conduction losses in a power rectifier
- AN4021: Calculation of reverse losses on a power diode

1.1 Characteristics (curves)

Figure 1. Average forward current versus case temperature ($\delta = 0.5$)

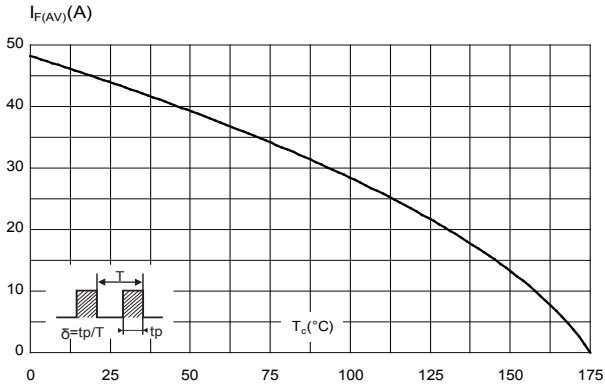

Figure 2. Relative variation of thermal impedance junction to case versus pulse duration

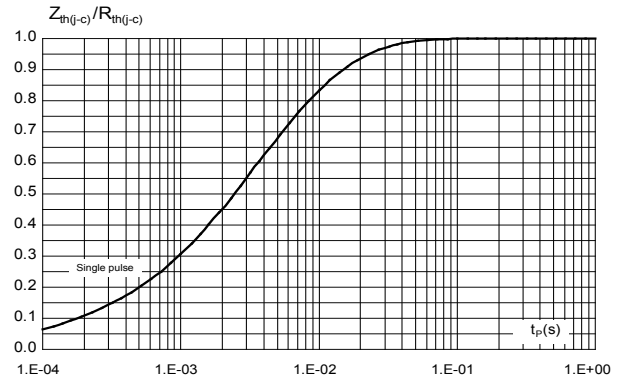

Figure 3. Reverse leakage current versus reverse voltage applied (typical values)

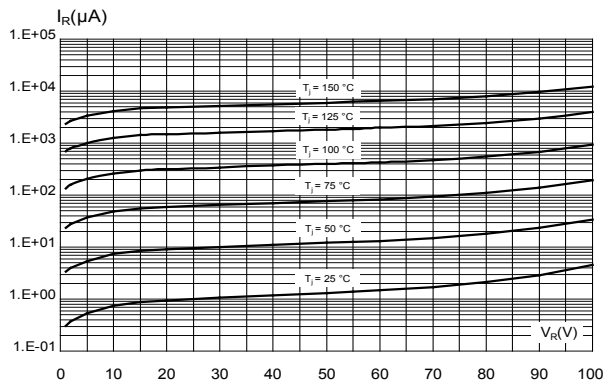

Figure 4. Junction capacitance versus reverse voltage applied (typical values)

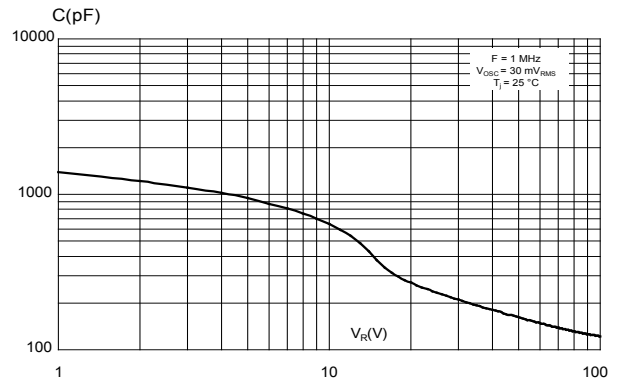

Figure 5. Forward voltage drop versus forward current (typical values)

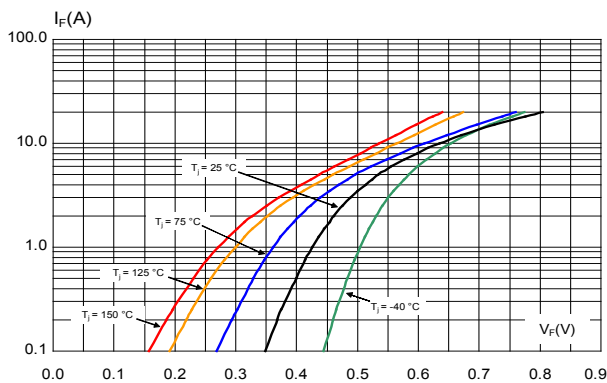
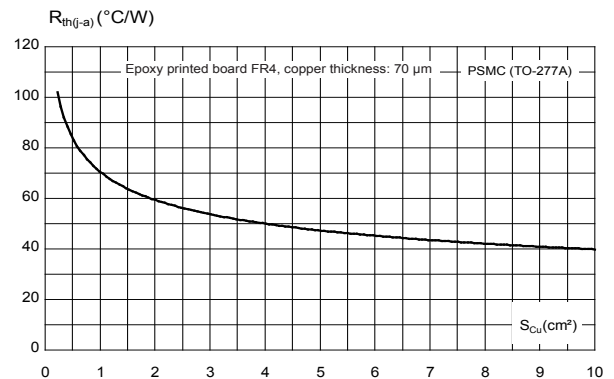

Figure 6. Thermal resistance junction to ambient versus copper surface under tab (typical values, epoxy printed board FR4, $e_{Cu} = 70 \mu m$)



2 Package information

In order to meet environmental requirements, ST offers these devices in different grades of **ECOPACK** packages, depending on their level of environmental compliance. ECOPACK specifications, grade definitions and product status are available at: www.st.com. ECOPACK is an ST trademark.

2.1 PSMC (TO-277A) package information

- Epoxy meets UL94,V0
- Cooling method : by conduction (C)

Figure 7. PSMC (TO-277A) package outline

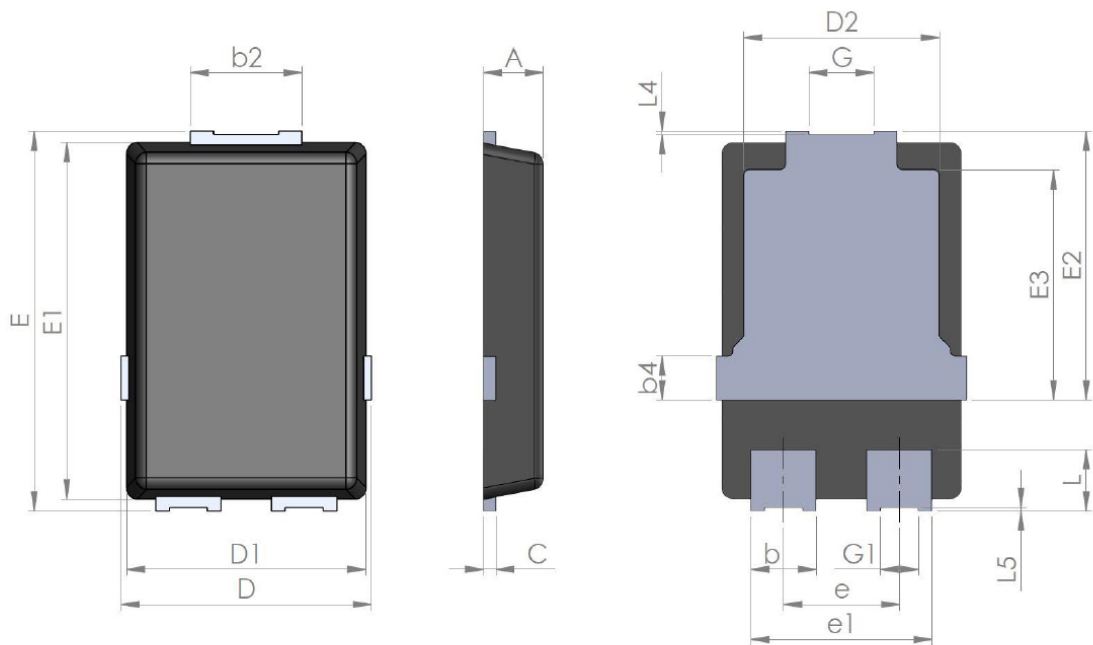
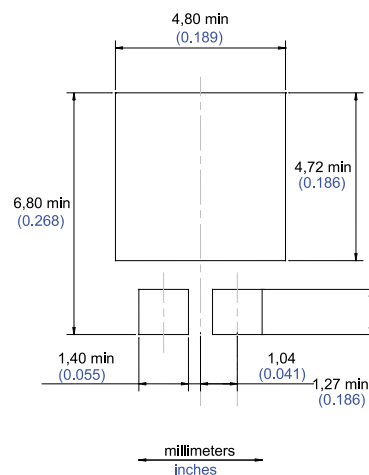

Table 4. PSMC (TO-277A) package mechanical data

Ref.	Dimensions					
	Millimeters			Inches (for reference only)		
	Min.	Typ.	Max.	Min.	Typ.	Max.
A	1.00	1.10	1.20	0.039	0.043	0.047
b	1.05	1.20	1.35	0.041	0.047	0.053
b2	1.90	2.05	2.20	0.075	0.081	0.087
b4		0.75			0.029	
C	0.15	0.23	0.40	0.006	0.009	0.016
D	4.45	4.60	4.75	0.175	0.181	0.187
D1	4.25	4.40	4.45	0.167	0.173	0.175
D2	3.40	3.60	3.70	0.134	0.142	0.146
E	6.35	6.50	6.65	0.250	0.256	0.262
E1	6.05	6.10	6.15	0.238	0.240	0.242
E2	4.50	4.60	4.70	0.177	0.181	0.185
E3		3.94			1.55	
e		2.13			0.084	
e1		3.33			0.131	
G		1.20			0.047	
G1		0.70			0.027	
L	0.90	1.05	1.24	0.035	0.041	0.049
L4	0.02			0.0008		
L5	0.02			0.0008		

Figure 8. PSMC (TO-277A) package footprint in mm (in inches)



Note: For package and tape orientation, reel and inner box dimensions and tape outline please check [TN1173](#)

3 Ordering information

Table 5. Ordering information

Order code	Marking	Package	Weight	Base qty.	Delivery mode
STPST10H100SFY	T10H1Y	PSMC (TO-277A)	90 mg	6000	Tape and reel

Revision history

Table 6. Document revision history

Date	Version	Changes
28-Jan-2021	1	Initial release.

IMPORTANT NOTICE – PLEASE READ CAREFULLY

STMicroelectronics NV and its subsidiaries (“ST”) reserve the right to make changes, corrections, enhancements, modifications, and improvements to ST products and/or to this document at any time without notice. Purchasers should obtain the latest relevant information on ST products before placing orders. ST products are sold pursuant to ST’s terms and conditions of sale in place at the time of order acknowledgement.

Purchasers are solely responsible for the choice, selection, and use of ST products and ST assumes no liability for application assistance or the design of Purchasers’ products.

No license, express or implied, to any intellectual property right is granted by ST herein.

Resale of ST products with provisions different from the information set forth herein shall void any warranty granted by ST for such product.

ST and the ST logo are trademarks of ST. For additional information about ST trademarks, please refer to www.st.com/trademarks. All other product or service names are the property of their respective owners.

Information in this document supersedes and replaces information previously supplied in any prior versions of this document.

© 2021 STMicroelectronics – All rights reserved