

# Printed-circuit board connector - MSTBA 2,5/ 4-G-5,08 - 1757268

Please be informed that the data shown in this PDF Document is generated from our Online Catalog. Please find the complete data in the user's documentation. Our General Terms of Use for Downloads are valid (<http://phoenixcontact.com/download>)

PCB headers, nominal current: 12 A, rated voltage (III/2): 320 V, number of positions: 4, pitch: 5.08 mm, color: green, contact surface: Tin, mounting: Wave soldering



The figure shows a 10-position version of the product

## Why buy this product

- Maximum flexibility when it comes to device design – one header for connectors with different connection technologies
- Well-known mounting principle allows worldwide use
- Plug-in direction parallel to the PCB
- Closed contour for optimum stability of the plug-in connection

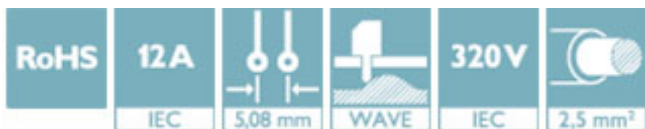

## Key Commercial Data

|                                      |   |
|--------------------------------------|---|
| Packing unit                         | 250 STK   |
| GTIN                                 | <br>4 017918 029791 |
| GTIN                                 | 4017918029791   |
| Weight per Piece (excluding packing) | 1.500 g   |
| Custom tariff number                 | 85366930  |
| Country of origin                    | Germany   |

## Technical data

### Dimensions

|                          |          |
|--------------------------|----------|
| Length [ l ]             | 12 mm    |
| Pitch                    | 5.08 mm  |
| Dimension a              | 15.24 mm |
| Width [ w ]              | 22.24 mm |
| Constructional height    | 8.6 mm   |
| Height [ h ]             | 12.1 mm  |
| Length of the solder pin | 3.5 mm   |
| Pin dimensions           | 1 x 1 mm |

# Printed-circuit board connector - MSTBA 2,5/ 4-G-5,08 - 1757268

## Technical data

### Dimensions

|               |        |
|---------------|--------|
| Hole diameter | 1.4 mm |
|---------------|--------|

### General

|  |                 |
|--|-----------------|
| Range of articles                      | MSTBA 2,5/...-G |
| Insulating material group              | I               |
| Rated surge voltage (III/3)            | 4 kV            |
| Rated surge voltage (III/2)            | 4 kV            |
| Rated surge voltage (II/2)             | 4 kV            |
| Rated voltage (III/3)                  | 250 V           |
| Rated voltage (III/2)                  | 320 V           |
| Rated voltage (II/2)                   | 400 V           |
| Connection in acc. with standard       | EN-VDE          |
| Nominal current $I_N$                  | 12 A            |
| Maximum load current                   | 12 A            |
| Insulating material                    | PA              |
| Flammability rating according to UL 94 | V0              |
| Color                                  | green           |
| Number of positions                    | 4               |

### Standards and Regulations

|  |        |
|--|--------|
| Connection in acc. with standard       | EN-VDE |
|  | CSA    |
| Flammability rating according to UL 94 | V0     |

### Environmental Product Compliance

|            |   |
|------------|---|
| China RoHS | Environmentally friendly use period: unlimited = EFUP-e |
|            | No hazardous substances above threshold values          |

## Drawings

Drilling diagram

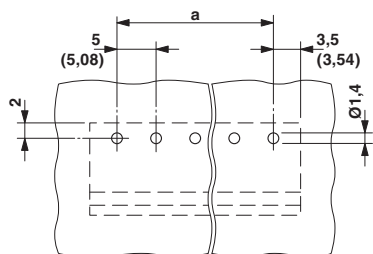

Diagram

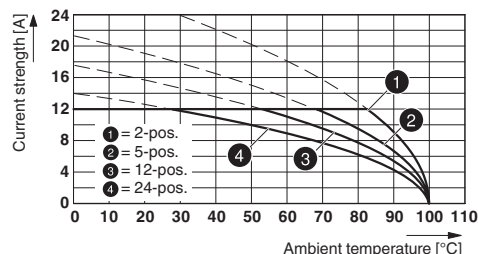

Type: ICV 2,5/...-G-5,08 with MSTBA 2,5/...-G-5,08

# Printed-circuit board connector - MSTBA 2,5/ 4-G-5,08 - 1757268

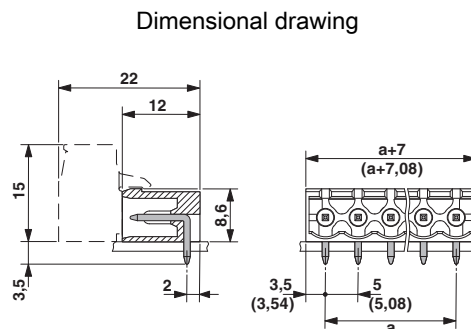
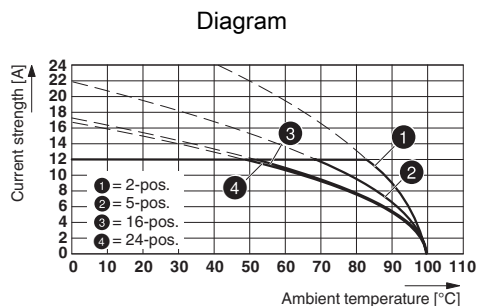

Type: IC 2,5/...-G-5,08 with MSTBA 2,5/...-G-5,08

## Classifications

eCl@ss

|            |          |
|------------|----------|
| eCl@ss 4.0 | 272607xx |
| eCl@ss 4.1 | 27260701 |
| eCl@ss 5.0 | 27260701 |
| eCl@ss 5.1 | 27260700 |
| eCl@ss 6.0 | 27260700 |
| eCl@ss 7.0 | 27440402 |
| eCl@ss 8.0 | 27440402 |
| eCl@ss 9.0 | 27440402 |

ETIM

|          |          |
|----------|----------|
| ETIM 3.0 | EC001121 |
| ETIM 4.0 | EC002637 |
| ETIM 5.0 | EC002637 |
| ETIM 6.0 | EC002637 |

UNSPSC

|               |          |
|---------------|----------|
| UNSPSC 6.01   | 30211810 |
| UNSPSC 7.0901 | 39121409 |
| UNSPSC 11     | 39121409 |
| UNSPSC 12.01  | 39121409 |
| UNSPSC 13.2   | 39121409 |

## Approvals

Approvals

Approvals

CSA / VDE Gutachten mit Fertigungsüberwachung / IECCE CB Scheme / cULus Recognized / EAC

Ex Approvals

# Printed-circuit board connector - MSTBA 2,5/ 4-G-5,08 - 1757268

## Approvals

### Approval details

|                    |       |   |                 |
|--------------------|-------|---|-----------------|
| CSA                |       | <a href="http://www.csagroup.org/services-industries/product-listing/">http://www.csagroup.org/services-industries/product-listing/</a> | LR13631-2585950 |
|                    | D     | B   |                 |
| Nominal voltage UN | 300 V | 300 V   |                 |
| Nominal current IN | 10 A  | 10 A  |                 |

|  |  |  |          |
|--|--|--|----------|
| VDE Gutachten mit<br>Fertigungsüberwachung |  | <a href="http://www2.vde.com/de/Institut/Online-Service/VDE-gepruefteProdukte/Seiten/Online-Suche.aspx">http://www2.vde.com/de/Institut/Online-Service/<br/>VDE-gepruefteProdukte/Seiten/Online-Suche.aspx</a> | 40004701 |
|  |  |  |          |
| Nominal voltage UN                         |  | 250 V  |          |
| Nominal current IN                         |  | 12 A   |          |

|                    |  |   |                |
|--------------------|--|---|----------------|
| IECEE CB Scheme    |  | <a href="http://www.iecee.org/">http://www.iecee.org/</a> | DE1-58978-B1B2 |
|                    |  |   |                |
| Nominal voltage UN |  | 250 V   |                |
| Nominal current IN |  | 12 A  |                |

|                    |       |   |                 |
|--------------------|-------|---|-----------------|
| cULus Recognized   |       | <a href="http://database.ul.com/cgi-bin/XYV/template/LISEXT/1FRAME/index.htm">http://database.ul.com/cgi-bin/XYV/template/LISEXT/1FRAME/index.htm</a> | E60425-19931011 |
|                    | D     | B   |                 |
| Nominal voltage UN | 300 V | 300 V   |                 |
| Nominal current IN | 10 A  | 15 A  |                 |

|     |  |  |         |
|-----|--|--|---------|
| EAC |  |  | B.01742 |
|-----|--|--|---------|

### Accessories

Accessories

Coding element

## Printed-circuit board connector - MSTBA 2,5/ 4-G-5,08 - 1757268

### Accessories

Coding star - CR-MSTB - 1734401



Coding section, inserted into the recess in the header or the inverted plug, red insulating material

---

### Filler plug

Accessories - MSTB-BL - 1755477



Keying cap, for forming sections, plugs onto header pin, green insulating material

---

### Labeled terminal marker

Marker card - SK 5,08/3,8:FORTL.ZAHLEN - 0804293



Marker card, Card, white, labeled, Horizontal: consecutive numbers 1 - 10, 11 - 20, etc. up to 91 - (99)100, mounting type: adhesive, for terminal block width: 5.08 mm, lettering field size: 5.08 x 3.8 mm

---

### Marker pen

Marker pen - B-STIFT - 1051993



Marker pen, for manual labeling of unprinted Zack strips, smear-proof and waterproof, line thickness 0.5 mm

---

### Terminal marking

Marker card - SK 5,08/3,8:UNBEDRUCKT - 0805412



Marker card, Card, white, unlabeled, can be labeled with: Marker pen, mounting type: adhesive, for terminal block width: 5.08 mm, lettering field size: 5.08 x 3.8 mm

## Printed-circuit board connector - MSTBA 2,5/ 4-G-5,08 - 1757268

### Accessories

#### Additional products

Printed-circuit board connector - TVMSTB 2,5/ 4-ST-5,08 - 1719024



PCB connector, nominal current: 12 A, rated voltage (III/2): 400 V, number of positions: 4, pitch: 5.08 mm, connection method: Screw connection with tension sleeve, color: green, contact surface: Tin

---

Printed-circuit board connector - FKCN 2,5/ 4-ST-5,08 - 1754584



PCB connector, nominal current: 12 A, rated voltage (III/2): 320 V, number of positions: 4, pitch: 5.08 mm, connection method: Push-in spring connection, color: green, contact surface: Tin

---

Printed-circuit board connector - MSTB 2,5/ 4-ST-5,08 - 1757035



PCB connector, nominal current: 12 A, rated voltage (III/2): 320 V, number of positions: 4, pitch: 5.08 mm, connection method: Screw connection with tension sleeve, color: green, contact surface: Tin

---

Printed-circuit board connector - MSTBP 2,5/ 4-ST-5,08 - 1769036



PCB connector, nominal current: 12 A, rated voltage (III/2): 320 V, number of positions: 4, pitch: 5.08 mm, connection method: Screw connection with tension sleeve, color: green, contact surface: Tin

---

Printed-circuit board connector - MSTB 2,5/ 4-STZ-5,08 - 1776155



PCB connector, nominal current: 12 A, rated voltage (III/2): 320 V, number of positions: 4, pitch: 5.08 mm, connection method: Screw connection with tension sleeve, color: green, contact surface: Tin

---

## Printed-circuit board connector - MSTBA 2,5/ 4-G-5,08 - 1757268

### Accessories

#### Printed-circuit board connector - FRONT-MSTB 2,5/ 4-ST-5,08 - 1777303

PCB connector, nominal current: 12 A, rated voltage (III/2): 320 V, number of positions: 4, pitch: 5.08 mm, connection method: Front screw connection, color: green, contact surface: Tin



#### Printed-circuit board connector - MSTBT 2,5/ 4-ST-5,08 - 1780002

PCB connector, nominal current: 12 A, rated voltage (III/2): 320 V, number of positions: 4, pitch: 5.08 mm, connection method: Screw connection with tension sleeve, color: green, contact surface: Tin



#### Printed-circuit board connector - MVSTBR 2,5/ 4-ST-5,08 - 1792265

PCB connector, nominal current: 12 A, rated voltage (III/2): 320 V, number of positions: 4, pitch: 5.08 mm, connection method: Screw connection with tension sleeve, color: green, contact surface: Tin



#### Printed-circuit board connector - MVSTBW 2,5/ 4-ST-5,08 - 1792773

PCB connector, nominal current: 12 A, rated voltage (III/2): 320 V, number of positions: 4, pitch: 5.08 mm, connection method: Screw connection with tension sleeve, color: green, contact surface: Tin



#### Printed-circuit board connector - MSTBC 2,5/ 4-ST-5,08 - 1808832

PCB connector, nominal current: 12 A, rated voltage (III/2): 320 V, number of positions: 4, pitch: 5.08 mm, connection method: Crimp connection, color: green, Corresponding female crimp contacts with current [A] and conductor cross section range [mm<sup>2</sup>] data: 10A/MSTBC-MT 0,5-1,0 (3190564); 10A/MSTBC-MT 0,5-1,0 BA (3190645); 12A/MSTBC-MT 1,5-2,5 (3190551); 12A/MSTBC-MT 1,5-2,5 BA (3190658). BA = Bandkontakte



## Printed-circuit board connector - MSTBA 2,5/ 4-G-5,08 - 1757268

### Accessories

#### Printed-circuit board connector - MSTBC 2,5/ 4-STZ-5,08 - 1809527



PCB connector, nominal current: 12 A, rated voltage (III/2): 320 V, number of positions: 4, pitch: 5.08 mm, connection method: Crimp connection, color: green, Corresponding female crimp contacts with current [A] and conductor cross section range [mm<sup>2</sup>] data: 10A/MSTBC-MT 0,5-1,0 (3190564); 10A/MSTBC-MT 0,5-1,0 BA (3190645); 12A/MSTBC-MT 1,5-2,5 (3190551); 12A/MSTBC-MT 1,5-2,5 BA (3190658). BA = Bandkontakte

#### Printed-circuit board connector - MSTBU 2,5/ 4-STD-5,08 - 1824146



Direct plug-in block, nominal current: 12 A, rated voltage (III/2): 320 V, number of positions: 4, pitch: 5.08 mm, connection method: Screw connection with tension sleeve, color: green, contact surface: Tin, mounting: Direct mounting

#### Printed-circuit board connector - MSTBU 2,5/ 4-ST-5,08-FL - 1824379



Direct plug-in block, nominal current: 12 A, rated voltage (III/2): 320 V, number of positions: 4, pitch: 5.08 mm, connection method: Screw connection with tension sleeve, color: green, contact surface: Tin, mounting: Direct mounting

#### Printed-circuit board connector - SMSTB 2,5/ 4-ST-5,08 - 1826306



PCB connector, nominal current: 12 A, rated voltage (III/2): 320 V, number of positions: 4, pitch: 5.08 mm, connection method: Screw connection with tension sleeve, color: green, contact surface: Tin

#### Printed-circuit board connector - TMSTBP 2,5/ 4-ST-5,08 - 1853036



PCB connector, nominal current: 12 A, rated voltage (III/2): 320 V, number of positions: 4, pitch: 5.08 mm, connection method: Screw connection with tension sleeve, color: green, contact surface: Tin, The plug allows conductors to be looped through from module to module.

## Printed-circuit board connector - MSTBA 2,5/ 4-G-5,08 - 1757268

### Accessories

#### Printed-circuit board connector - FKC 2,5/ 4-ST-5,08 - 1873074

PCB connector, nominal current: 12 A, rated voltage (III/2): 320 V, number of positions: 4, pitch: 5.08 mm, connection method: Push-in spring connection, color: green, contact surface: Tin



#### Printed-circuit board connector - FKCVW 2,5/ 4-ST-5,08 - 1873676

PCB connector, nominal current: 12 A, rated voltage (III/2): 320 V, number of positions: 4, pitch: 5.08 mm, connection method: Push-in spring connection, color: green, contact surface: Tin



#### Printed-circuit board connector - FKCVR 2,5/ 4-ST-5,08 - 1873977

PCB connector, nominal current: 12 A, rated voltage (III/2): 320 V, number of positions: 4, pitch: 5.08 mm, connection method: Push-in spring connection, color: green, contact surface: Tin



#### Printed-circuit board connector - QC 1/ 4-ST-5,08 - 1883271

PCB connector, nominal current: 10 A, rated voltage (III/2): 630 V, number of positions: 4, pitch: 5.08 mm, connection method: Displacement connection, color: green, contact surface: Tin

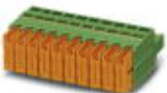

#### Printed-circuit board connector - FKCT 2,5/ 4-ST-5,08 - 1902136

PCB connector, nominal current: 12 A, rated voltage (III/2): 320 V, number of positions: 4, pitch: 5.08 mm, connection method: Push-in spring connection, color: green, contact surface: Tin



## Printed-circuit board connector - MSTBA 2,5/ 4-G-5,08 - 1757268

### Accessories

Printed-circuit board connector - TFKC 2,5/ 4-ST-5,08 - 1962626

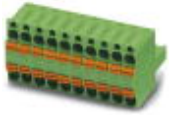

PCB connector, nominal current: 12 A, rated voltage (III/2): 320 V, number of positions: 4, pitch: 5.08 mm, connection method: Push-in spring connection, color: green, contact surface: Tin

---

Printed-circuit board connector - FKCS 2,5/ 4-ST-5,08 - 1975095



PCB connector, nominal current: 12 A, rated voltage (III/2): 320 V, number of positions: 4, pitch: 5.08 mm, connection method: Push-in spring connection, color: green, contact surface: Tin

---

---