

Base strip - MCV 1,5/ 5-G-3,5 - 1843635

Please be informed that the data shown in this PDF Document is generated from our Online Catalog. Please find the complete data in the user's documentation. Our General Terms of Use for Downloads are valid (<http://phoenixcontact.com/download>)

Header, Nominal current: 8 A, Rated voltage (III/2): 160 V, Number of positions: 5, Pitch: 3.5 mm, Color: green, Contact surface: Tin, Mounting: Wave soldering



The figure shows a 10-position version of the product

Why buy this product

- Well-known mounting principle allows worldwide use
- Vertical connection enables multi-row arrangement on the PCB
- Maximum flexibility when it comes to device design – one header for connectors with different connection technologies



Key Commercial Data

Packing unit	250 STK
GTIN	 4 017918 112783
GTIN	4017918112783
Weight per Piece (excluding packing)	1.360 g
Custom tariff number	85366990
Country of origin	Germany

Technical data

Dimensions

Length	7.25 mm
Pitch	3.5 mm
Dimension a	14 mm
Width	18.9 mm
Constructional height	9.2 mm
Height	12.6 mm
Length of the solder pin	3.4 mm
Pin dimensions	0,8 x 0,8 mm
Hole diameter	1.2 mm

Base strip - MCV 1,5/ 5-G-3,5 - 1843635

Technical data

General

Range of articles	MCV 1,5/...-G
Insulating material group	IIIa
Rated surge voltage (III/3)	2.5 kV
Rated surge voltage (III/2)	2.5 kV
Rated surge voltage (II/2)	2.5 kV
Rated voltage (III/3)	160 V
Rated voltage (III/2)	160 V
Rated voltage (II/2)	250 V
Connection in acc. with standard	EN-VDE
Nominal current I_N	8 A
Maximum load current	8 A
Insulating material	PBT
Flammability rating according to UL 94	V0
Color	green
Number of positions	5

Standards and Regulations

Connection in acc. with standard	EN-VDE
	CSA
Flammability rating according to UL 94	V0

Environmental Product Compliance

China RoHS	Environmentally friendly use period: unlimited = EFUP-e
	No hazardous substances above threshold values

Drawings

Drilling diagram

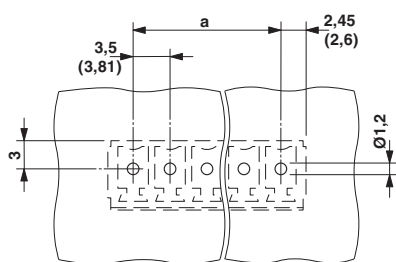

Diagram

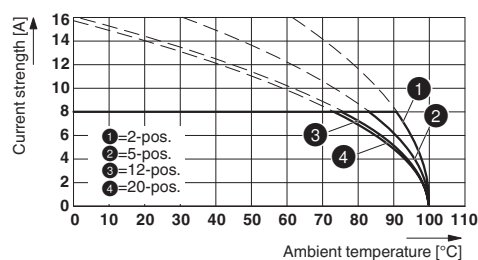

Type: MC 1,5/...-ST-3,5 with MCV 1,5/...-G-3,5

Base strip - MCV 1,5/ 5-G-3,5 - 1843635

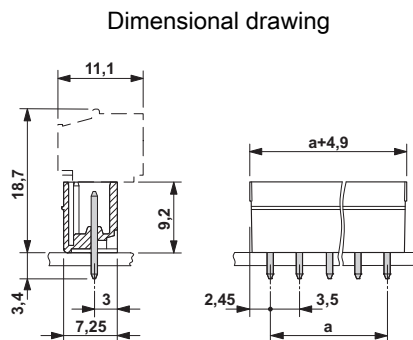
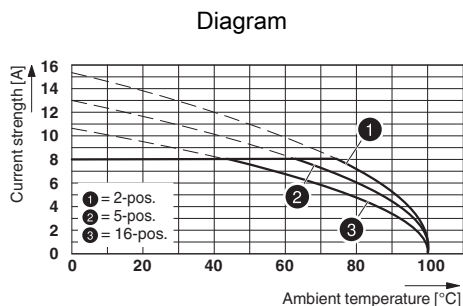

Type: MCVW 1,5/...-ST-3,5 with MCV 1,5/...-G-3,5

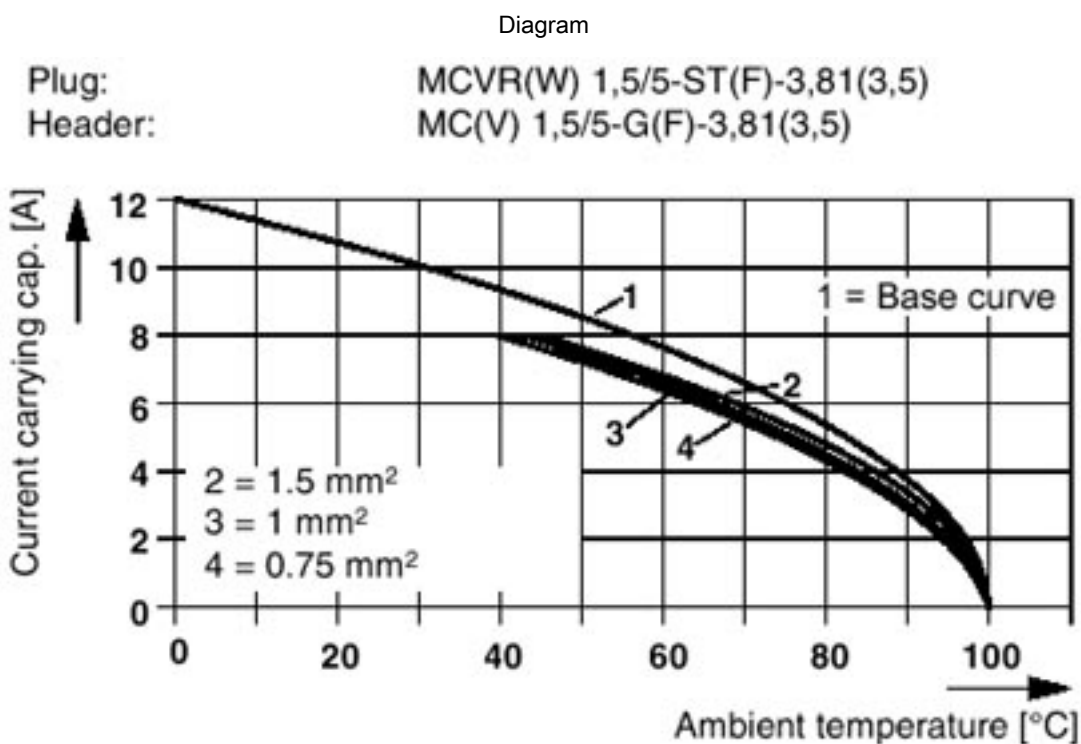

Base strip - MCV 1,5/ 5-G-3,5 - 1843635

Diagram

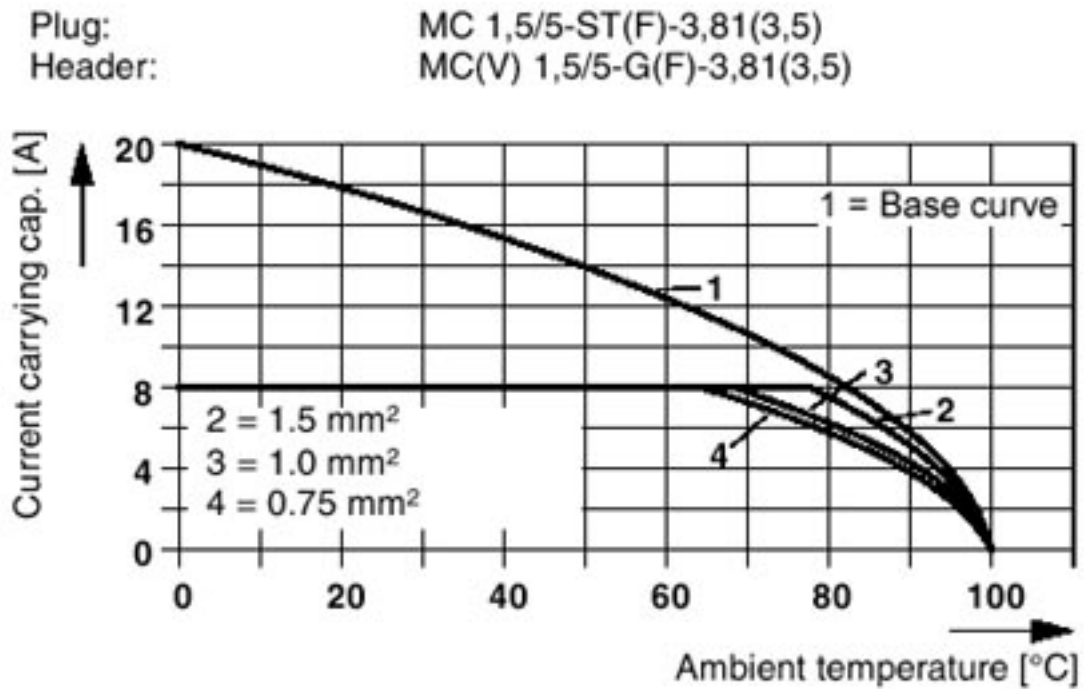

Classifications

eCl@ss

eCl@ss 4.0	272607xx
eCl@ss 4.1	27260701
eCl@ss 5.0	27260701
eCl@ss 5.1	27260701
eCl@ss 6.0	27260704
eCl@ss 7.0	27440402
eCl@ss 8.0	27440402
eCl@ss 9.0	27440402

ETIM

ETIM 3.0	EC001121
ETIM 4.0	EC002637
ETIM 5.0	EC002637
ETIM 6.0	EC002637

UNSPSC

UNSPSC 6.01	30211810
UNSPSC 7.0901	39121409
UNSPSC 11	39121409
UNSPSC 12.01	39121409
UNSPSC 13.2	39121409

Base strip - MCV 1,5/ 5-G-3,5 - 1843635

Approvals

Approvals

Approvals

CSA / VDE Gutachten mit Fertigungsüberwachung / IECCEB Scheme / CCA / cULus Recognized / EAC

Ex Approvals

Approval details

CSA		http://www.csagroup.org/services/testing-and-certification/certified-product-listing/	13631
		B	D
Nominal current IN		8 A	8 A
Nominal voltage UN		300 V	300 V

VDE Gutachten mit Fertigungsüberwachung		http://www.vde.com/en/Institute/OnlineService/VDE-approved-products/Pages/Online-Search.aspx	40011723
Nominal current IN		8 A	
Nominal voltage UN		160 V	

IECEE CB Scheme		http://www.iecee.org/	DE1-56063-B1B2
Nominal current IN		8 A	
Nominal voltage UN		160 V	

CCA			CCA/ DE1 34219
Nominal current IN		8 A	
Nominal voltage UN		160 V	

cULus Recognized		http://database.ul.com/cgi-bin/XYV/template/LISEXT/1FRAME/index.htm	E60425-20110128
		B	D
Nominal current IN		8 A	8 A

Base strip - MCV 1,5/ 5-G-3,5 - 1843635

Approvals

	B	D
Nominal voltage UN	300 V	300 V

EAC		B.01742
-----	--	---------

Accessories

Accessories

Coding element

Coding profile - CP-MSTB - 1734634

Coding profile, is inserted into the slot on the plug or inverted header, red insulating material



Labeled terminal marker

Marker card - SK 3,5/2,8:FORTL.ZAHLEN - 0804073



Marker card, Card, white, labeled, Horizontal: Consecutive numbers 1 - 10, 11 - 20, etc. up to 91 - 99, Mounting type: Adhesive, for terminal block width: 3.5 mm, Lettering field: 3.5 x 2.8 mm

Marker pen

Marker pen - B-STIFT - 1051993



Marker pen, for manual labeling of unprinted Zack strips, smear-proof and waterproof, line thickness 0.5 mm

Terminal marking

Base strip - MCV 1,5/ 5-G-3,5 - 1843635

Accessories

Marker card - SK U/2,8 WH:UNBEDRUCKT - 0803883



Marker card, Sheet, white, unlabeled, can be labeled with: Plotter, Office printing systems, Mounting type: Adhesive, Lettering field: 186 x 2.8 mm

Additional products

Printed-circuit board connector - MC 1,5/ 5-ST-3,5 GY7035 - 1769087



Plug component, Nominal current: 8 A, Rated voltage (III/2): 160 V, Number of positions: 5, Pitch: 3.5 mm, Connection method: Screw connection with tension sleeve, Color: light gray, Contact surface: Tin

Printed-circuit board connector - TFMC 1,5/ 5-ST-3,5 - 1772647



Plug component, Nominal current: 8 A, Rated voltage (III/2): 160 V, Number of positions: 5, Pitch: 3.5 mm, Connection method: Push-in spring connection, Color: green, Contact surface: Tin

Printed-circuit board connector - MC 1,5/ 5-ST-3,5 - 1840395



Plug component, Nominal current: 8 A, Rated voltage (III/2): 160 V, Number of positions: 5, Pitch: 3.5 mm, Connection method: Screw connection with tension sleeve, Color: green, Contact surface: Tin

Printed-circuit board connector - MCVW 1,5/ 5-ST-3,5 - 1862881



Plug component, Nominal current: 8 A, Rated voltage (III/2): 160 V, Number of positions: 5, Pitch: 3.5 mm, Connection method: Screw connection with tension sleeve, Color: green, Contact surface: Tin

Base strip - MCV 1,5/ 5-G-3,5 - 1843635

Accessories

Printed-circuit board connector - MCVR 1,5/ 5-ST-3,5 - 1863181



Plug component, Nominal current: 8 A, Rated voltage (III/2): 160 V, Number of positions: 5, Pitch: 3.5 mm, Connection method: Screw connection with tension sleeve, Color: green, Contact surface: Tin

Printed-circuit board connector - FK-MCP 1,5/ 5-ST-3,5 - 1939947

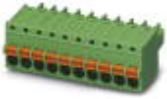

Plug component, Nominal current: 8 A, Rated voltage (III/2): 160 V, Number of positions: 5, Pitch: 3.5 mm, Connection method: Push-in spring connection, Color: green, Contact surface: Tin

Printed-circuit board connector - FMC 1,5/ 5-ST-3,5 - 1952296



Plug component, Nominal current: 8 A, Rated voltage (III/2): 160 V, Number of positions: 5, Pitch: 3.5 mm, Connection method: Push-in spring connection, Color: green, Contact surface: Tin
