

SPECIFICATION

Part No. : **WPC.25A.07.0150C**

Product Name : 2.4GHz Ceramic Patch Antenna on integral ground with cable and connector

Feature : High antenna RF efficiency
150mm 1.13 IPEX MHFI
RoHS compliant



1. Introduction

The WPC.25A 2.4GHz Ceramic Patch Antenna with cable works on Wi-Fi, Zigbee, Bluetooth and ISM band at 2.4GHz. This antenna comprises of a 2.4GHz 25*25*4mm embedded patch with mini-coax cable and connector for connectivity and a PCB carrier to mount the antenna. The antenna has its own ground PCB carrier and is therefore ground independent.

Many module manufacturers specify peak gain limits for any antennas that are to be connected to that module. Those peak gain limits are based on free-space conditions. In practice, the peak gain of an antenna tested in free-space can degrade by at least 1 or 2dBi when put inside a device. So ideally you should go for a slightly higher peak gain antenna than mentioned on the module specification to compensate for this effect, giving you better performance.

Upon testing of any of our antennas with your device and a selection of appropriate layout, integration technique, or cable, Taoglas can make sure any of our antennas' peak gain will be below the peak gain limits. Taoglas can then issue a specification and/or report for the selected antenna in your device that will clearly show it complying with the peak gain limits, so you can be assured you are meeting regulatory requirements for that module.

For example, a module manufacturer may state that the antenna must have less than 2dBi peak gain, but you don't need to select an embedded antenna that has a peak gain of less than 2dBi in free-space. This will give you a less optimized solution. It is better to go for a slightly higher free-space peak gain of 3dBi or more if available. Once that antenna gets integrated into your device, performance will degrade below this 2dBi peak gain due to the effects of GND

plane, surrounding components, and device housing. If you want to be absolutely sure, contact Taoglas and we will test. Choosing a Taoglas antenna with a higher peak gain than what is specified by the module manufacturer and enlisting our help will ensure you are getting the best performance possible without exceeding the peak gain limits.

2. Specification

Wi-Fi	
Frequency (MHz)	2400~2500
Peak Gain (dBi)	> 0.5
Average Gain (dBi)	>-2.5
Efficiency (%)	> 50
Impedance	50Ω
Polarization	Broadly Linear
Input Power	10 W
MECHANICAL	
Dimensions	25*25*5.5mm
Cable type	1.37 mini coaxial cable
Cable length	150mm
Connector	IPEX MHF1
ENVIRONMENTAL	
Temperature Range	-40°C to 85°C
Humidity	Non-condensing 65°C 95% RH

3. Antenna Characteristics

3.1 Return loss

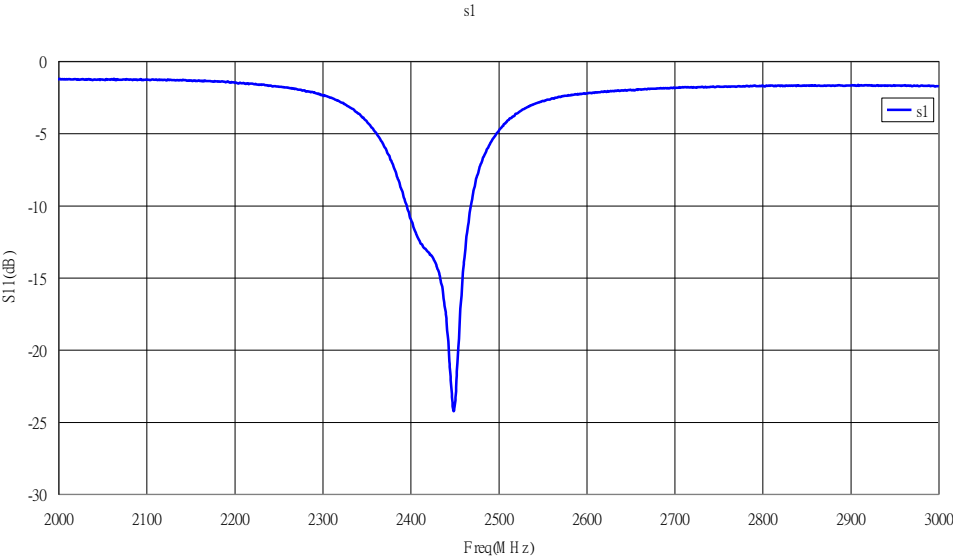

3.2 Antenna Efficiency

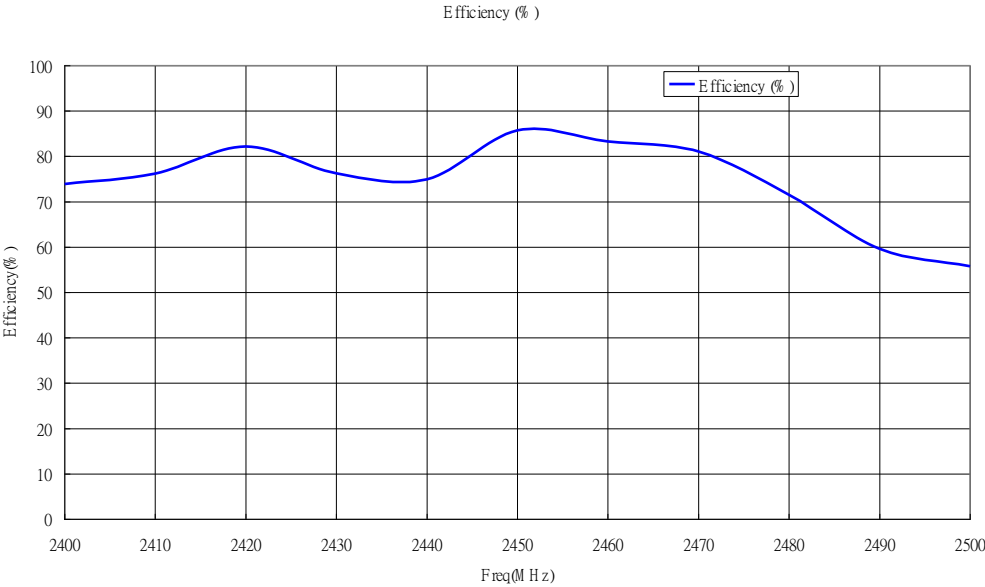

3.3 Peak Gain

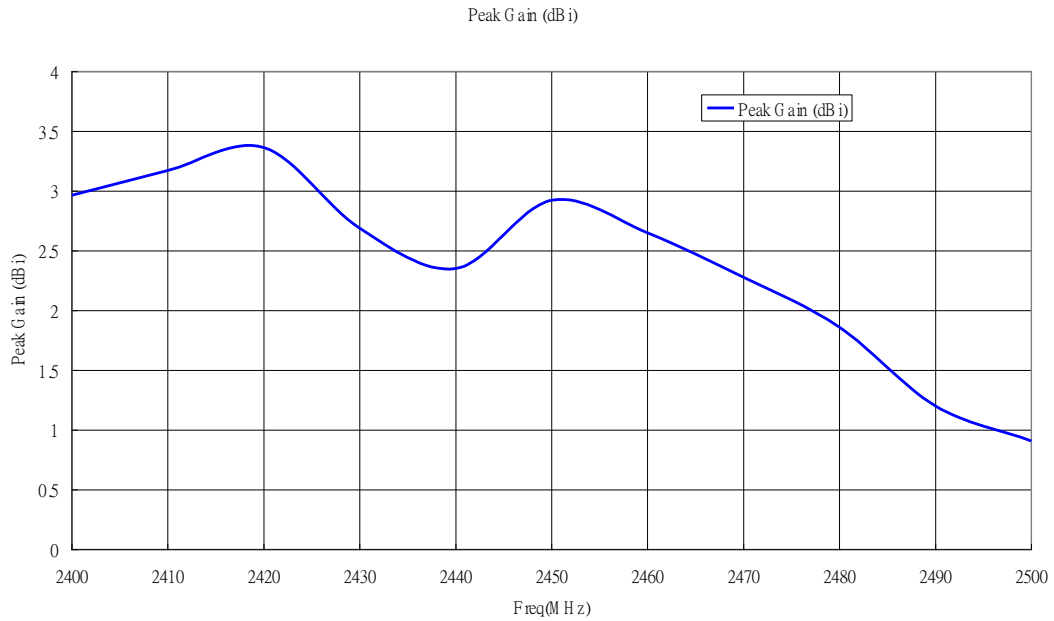

4. Antenna Radiation Pattern

4.1 Antenna Stand Alone

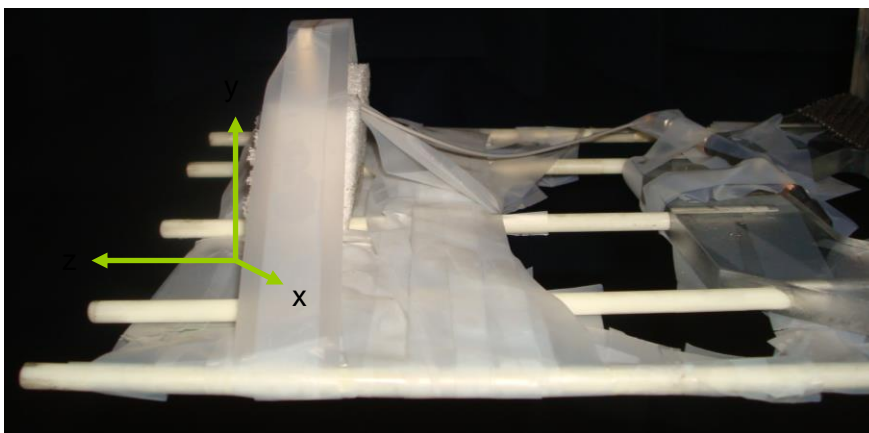



4.2 XZ plane

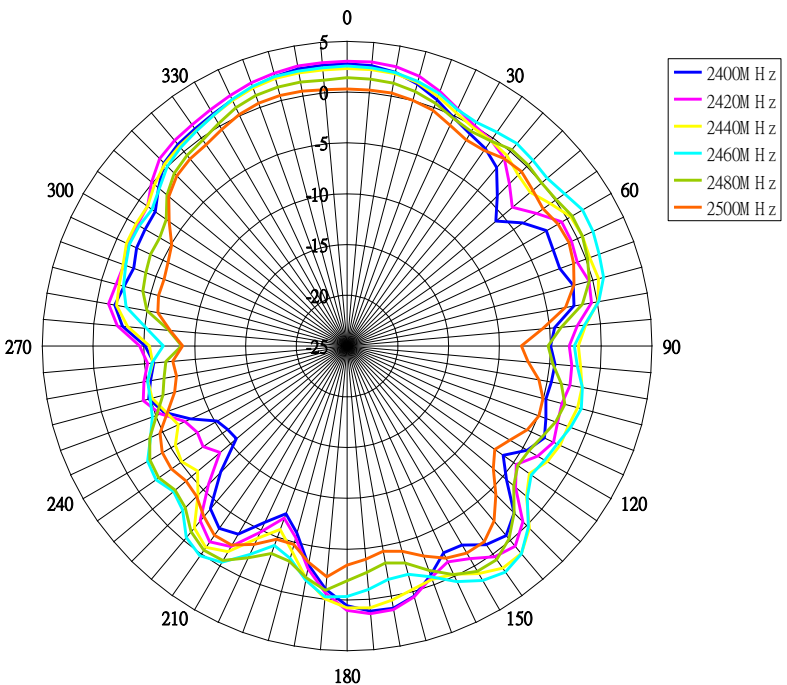

4.3 YZ plane

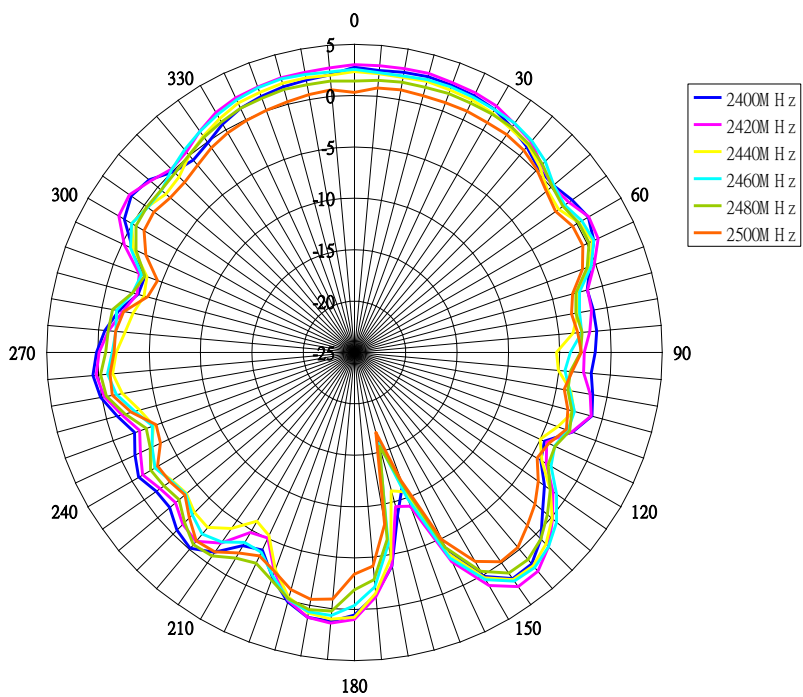



4.4 XY plane

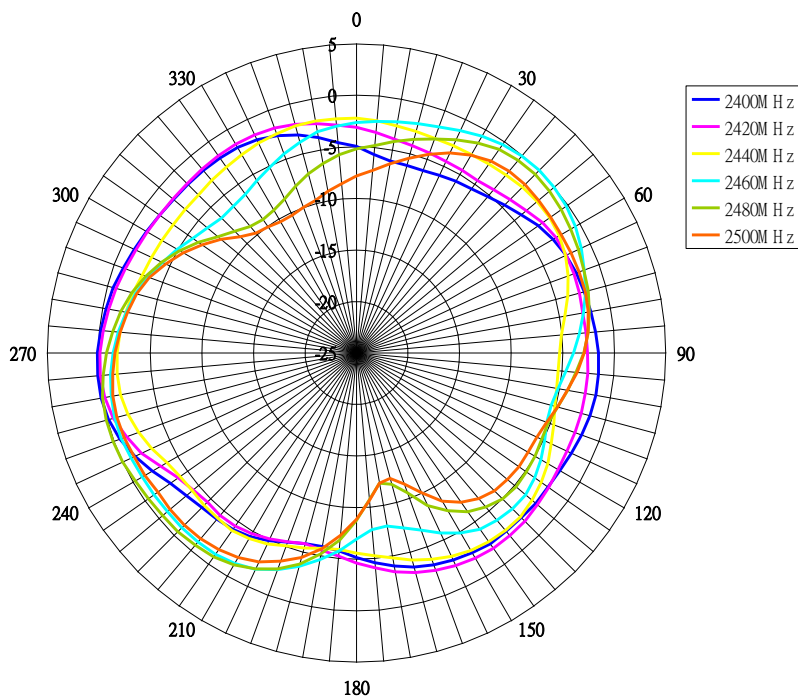

5. Mechanical Drawing

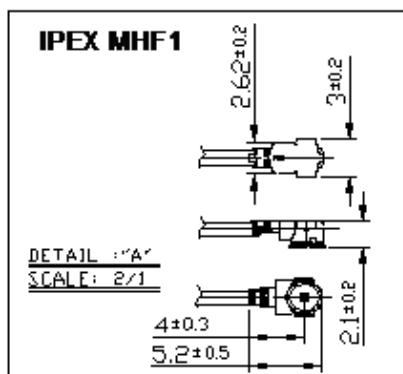
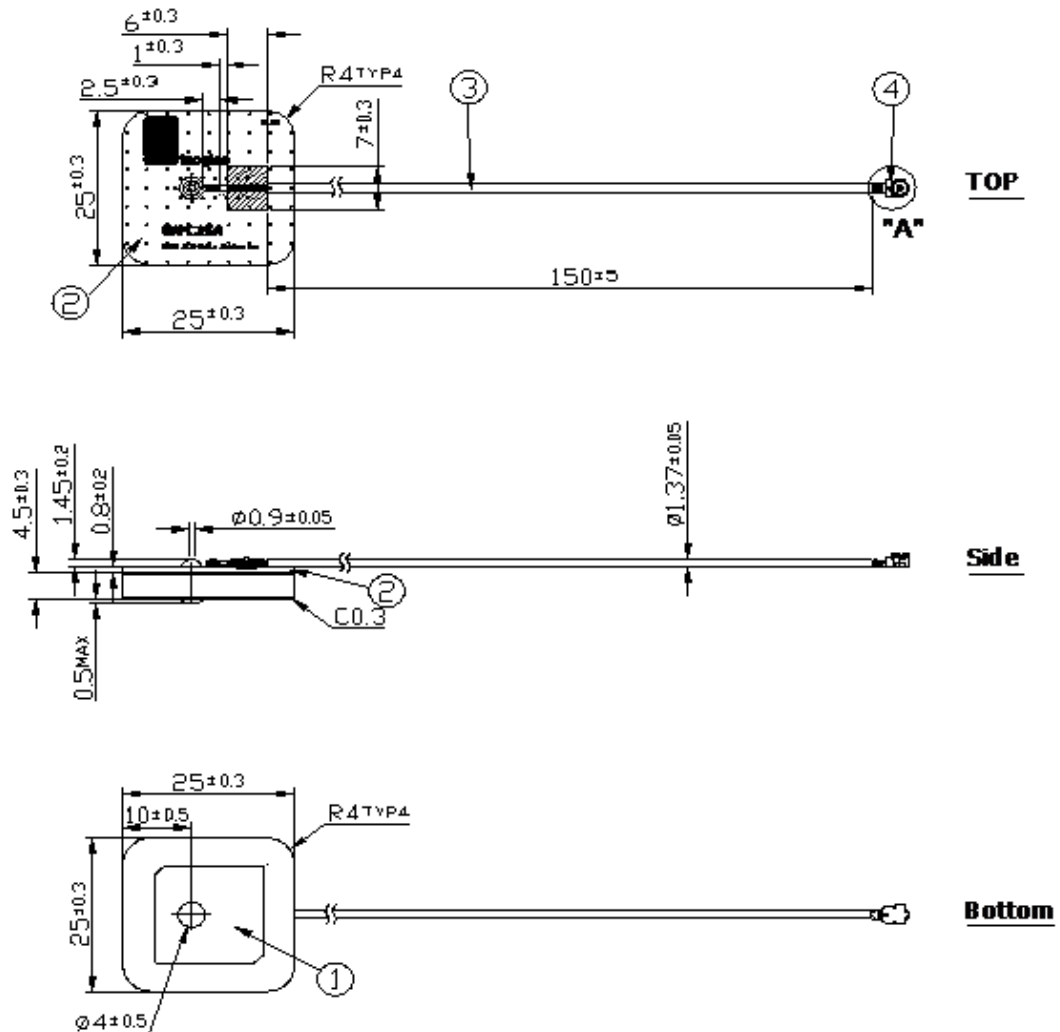

	Name	Material	Finish	QTY
1	WLP.2450 Patch 25x25x4	Ceramic	Clear	1
2	WPC.25A PCB	FR4 D.28	Black	1
3	1.37 Coaxial Cable	FEP	Black/Gray	1
4	IPEX MHF1	Brass	Gold	1

6. Packaging

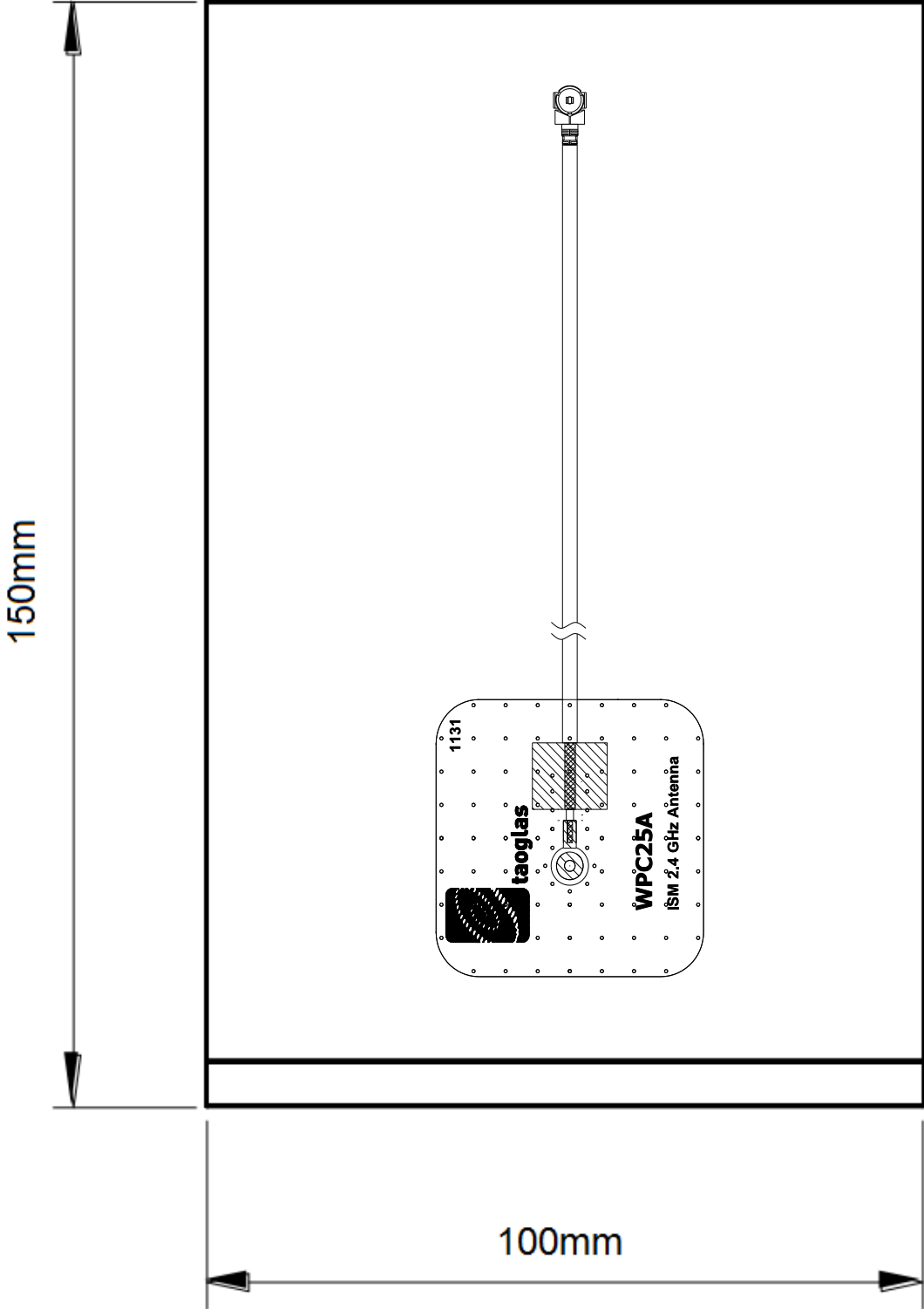

Each Antenna is packaged in a PE Bag 100mm*150mm



TAOGLAS®

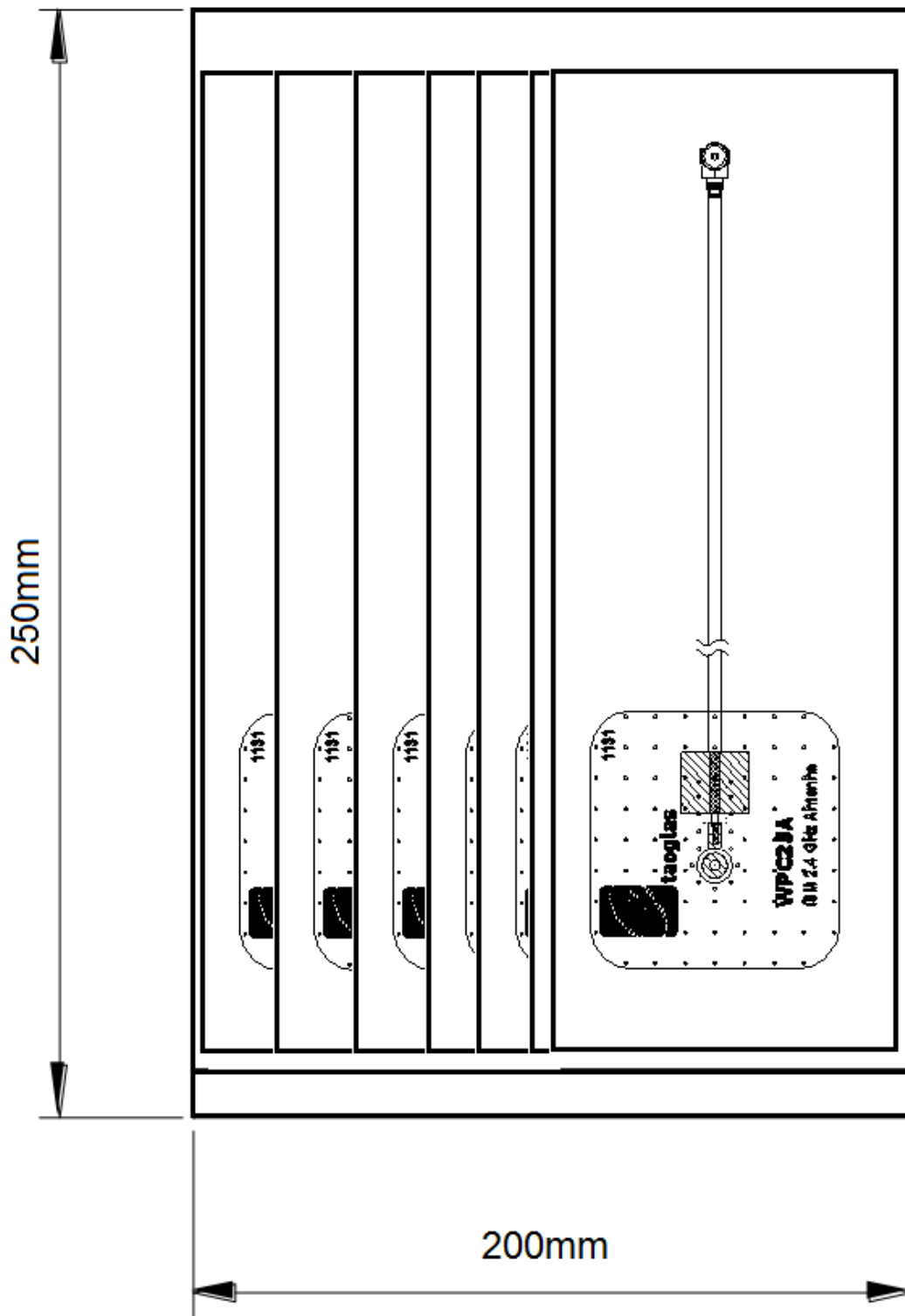

10 Antennas are then packaged in an Outer PE Bag: 250mm*200mm