



TAOGLAS®



Datasheet

Multiband GNSS, Stacked Terrablast Patch Antenna

Part No:
HP5010A

Description:

50x50x10.5mm Terrablast GPS L1/L2/L5 Patch Antenna, 1176.45-1227.6MHz, 1561-1610MHz

Features:

- GPS L1, GPS L2 and GPS L5 band, GLONASS, Galileo and BeiDou Operation
- Right-Hand Circularly Polarized Patch
- Single Feed Patch Assembly
- Ultra-Impact Resistant Terrablast Material
- Dimensions: 50*50*10.5mm
- Tuned for Centre Positioning on a 70*70mm Ground-plane
- Patent Pending Design
- RoHS & REACH Compliant

1. Introduction	3
2. Specifications	4
3. Antenna Characteristics	6
4. Radiation Patterns	12
5. Mechanical Drawing	18
6. Soldering Recommendations	19
7. Packaging	20
<hr/>	
Changelog	21

Taoglas makes no warranties based on the accuracy or completeness of the contents of this document and reserves the right to make changes to specifications and product descriptions at any time without notice. Taoglas reserves all rights to this document and the information contained herein.

Reproduction, use or disclosure to third parties without express permission is strictly prohibited.



1. Introduction



The Taoglas HP5010A is a triple stacked 50*50*10.5mm Terrablast GPS L1, GPS L2 and GPS L5, GLONASS, BeiDou embedded passive patch antenna with 10.5mm thickness. This patch is made from Terrablast, a revolutionary new material developed to meet the unique needs of the UAV and automotive industries. It uses a patent pending antenna technology which results in much lighter weight and built to withstand greater impacts.

Typical applications include:

- :: Transportation
- :: Defence
- :: E-Mobility
- :: Agriculture
- :: UAV navigation

The antenna has been tuned and tested on a 70*70mm ground plane, working at GPS L1: 1575.42MHz, L2: 1227.6MHz and L5: 1176.45MHz. This Terrablast patch also operates at other worldwide Navigation systems such as GLONASS, Galileo and BeiDou.

The HP5010A is mounted via a pin and double-sided adhesive. This antenna works well without modifications in most environment but can be tuned and further optimized to different ground planes and enclosures if this is required. Custom antenna modifications are subject to possible NRE and minimum order quantity.

Terrablast antennas are not suitable for SMD reflow. The correct method is manual soldering at a soldering temperature of 380°C +/- 20°C for a duration of 3 to 5 seconds. All Terrablast antennas undergo rigorous temperature, vibration and impact tests and exceed the highest ISO16750 standards.

For further information, or support to test and integrate Taoglas Terrablast technology please contact your regional Taoglas customer support team.

2. Specifications

GNSS Frequency Bands Covered						
GPS	L1	L2	L5			
	■	■	■			
GLONASS	G1	G2	G3			
	■	■	■			
Galileo	E1	E5a	E5b	E6		
	■	■	■	□		
BeiDou	B1	B2a	B2b	B3		
	■	■	■	■		
QZSS (Regional)	L1	L2C	L5	L6		
	■	■	■	□		
IRNSS (Regional)	L5					
	■					
SBAS	L1/E1/B1	L5/B2a/E5a	G1	G2	G3	
	■	■	■	■	■	

*SBAS systems: WASS(L1/L5), EGNOS(E1/E5a), SDCM(G1/G2/G3), SNAS(B1,B2a), GAGAN(L1/L5), QZSS(L1/L5), KAZZ(L1/L5).

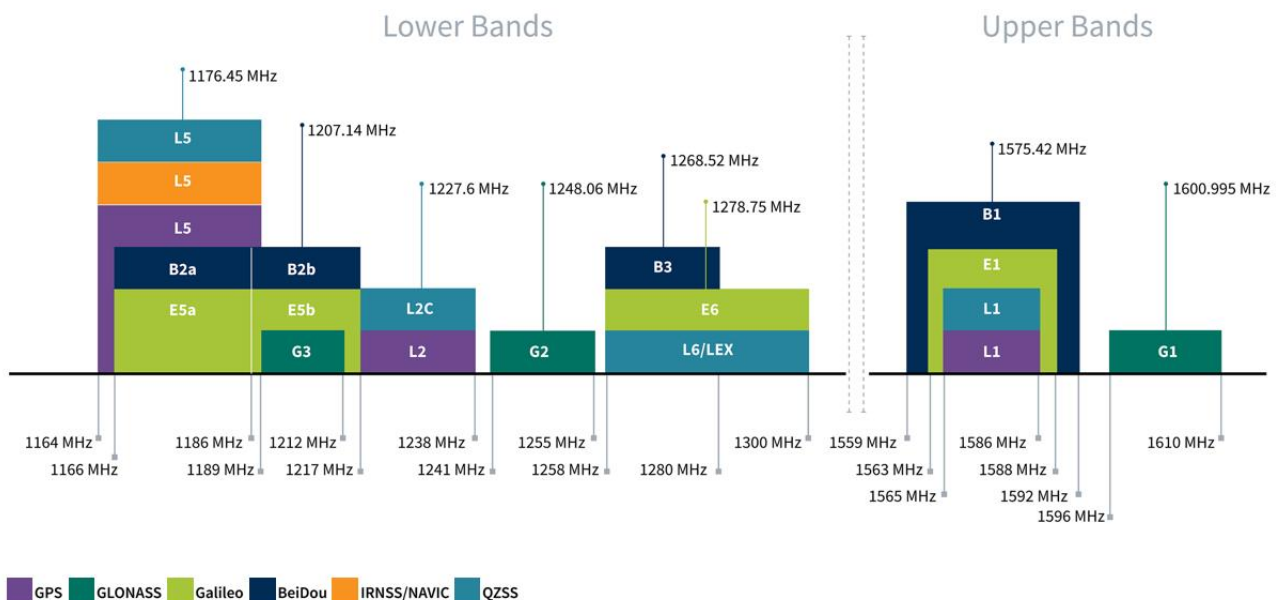

GNSS Bands and Constellations

GNSS Electrical					
Frequency (MHz)	1176.45	1227.6	1561	1575.42	1602
VSWR (max.)	2.0:1	2.0:1	2.0:1	2.0:1	2.0:1
Passive Antenna Efficiency (%)	58.4	78.5	62.6	64.7	68.2
Passive Antenna Gain at Zenith (dBi)	3.0	3.7	3.6	3.7	4.0
Average Gain (dB)	10.8	17.1	10.4	4.98	7.3
Polarization	RHCP				
Impedance	50Ω				
Mechanical					
Height	10.5 ±2 mm				
Planner Dimension	50*50*10 mm				
Weight	59.5 g				
Environmental					
Temperature Range	-40°C to 85°C				
Humidity	Non-condensing 65°C 95% RH				

Field Test Result

Frequency	GPS L1	GPS L2	Galileo E1	Galileo E5b	GLONASS G1	GLONASS G2	BeiDou B1I	BeiDou B2I
	1563-1587	1215-1239.6	1559-1591	1189-1214	1598-1605	1242-1249	1559-1563	1200-1214
Tracking Number without RTK (dB-Hz)	39	32.3	37.4	37.5	36.8	33.5	38.4	33.5
2*DRMS Positioning Accuracy (cm) without RTK	95	95	95	95	95	95	95	95
TTF(s) without RTK	23	23	23	23	23	23	23	23
Tracking Number with RTK (dB-Hz)	39	32.3	37.4	37.5	36.8	33.5	38.4	33.5
2*DRMS Positioning Accuracy (cm) with RTK	20	20	20	20	20	20	20	20
TTF(s) with RTK	23	23	23	23	23	23	23	23
Group Delay @ Zenith Variation Across Single Constellation(ns)	2	6	2	6	2	6	2	6
Phase Centre Offset PCO (cm)	0.03	0.57	0.03	0.57	0.03	0.57	0.03	0.57
Phase Centre Variation PCV (mm) including Active Circuitry	8	10	8	10	8	10	8	10
Axial Ratio Phase Centre Variation	6	15	6	15	6	15	6	15

*All outdoor measurements performed on the roof top of the Taoglas R&D Labs facility in Dublin Ireland.

** Recommended Minimum C/No for Standard Precision Acquisition/ Tracking (dB-Hz): 26-30/ 12-15.

***Data Measured Free Space.

****Group Delay, PCO, PCV and Axial Ratio values includes Active Circuitry.

*****Ublox C099-F9P application board is used for Field test Measurements.

■ NO RTK ■ FLOAT ■ FIXED

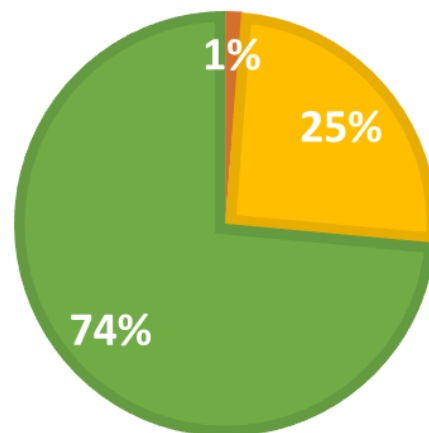

3. Antenna Characteristics

3.1 Measurement environment

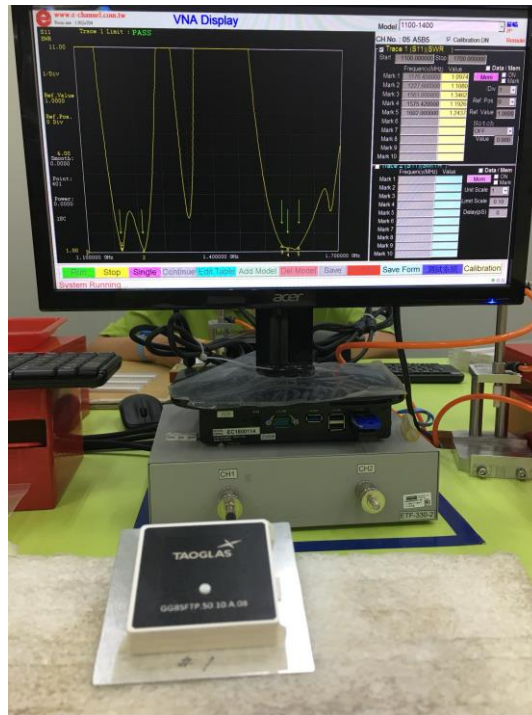

3.2 Return Loss

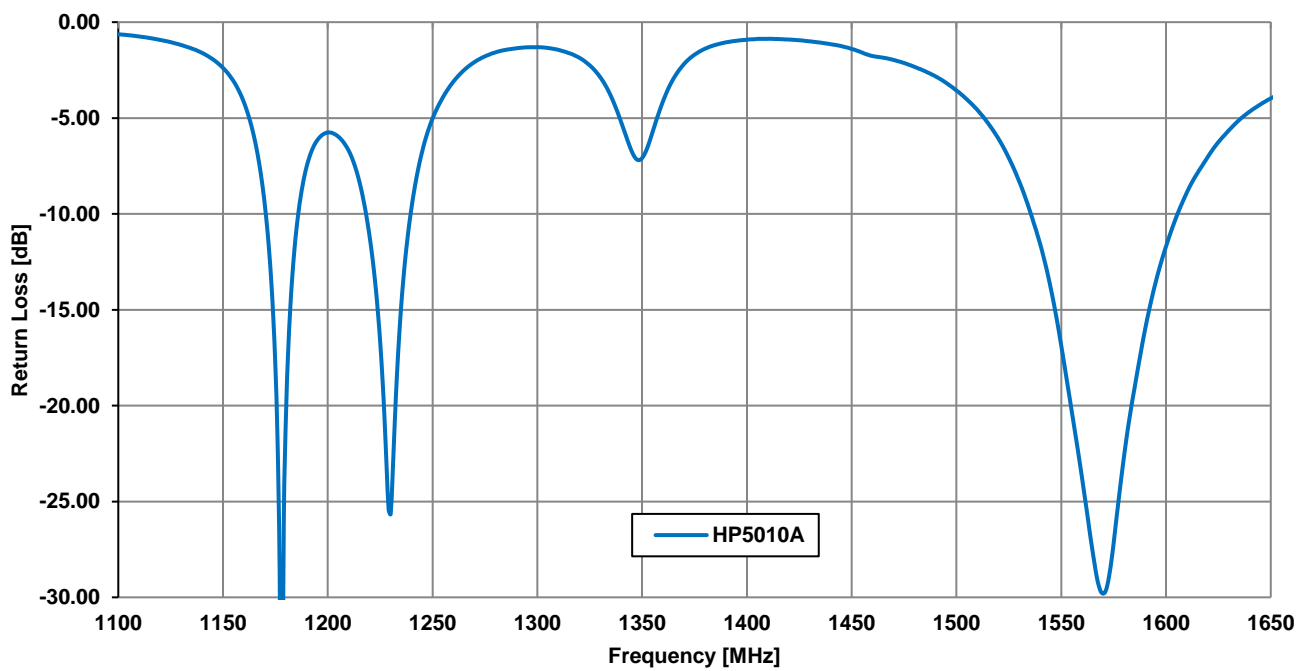

3.3 VSWR

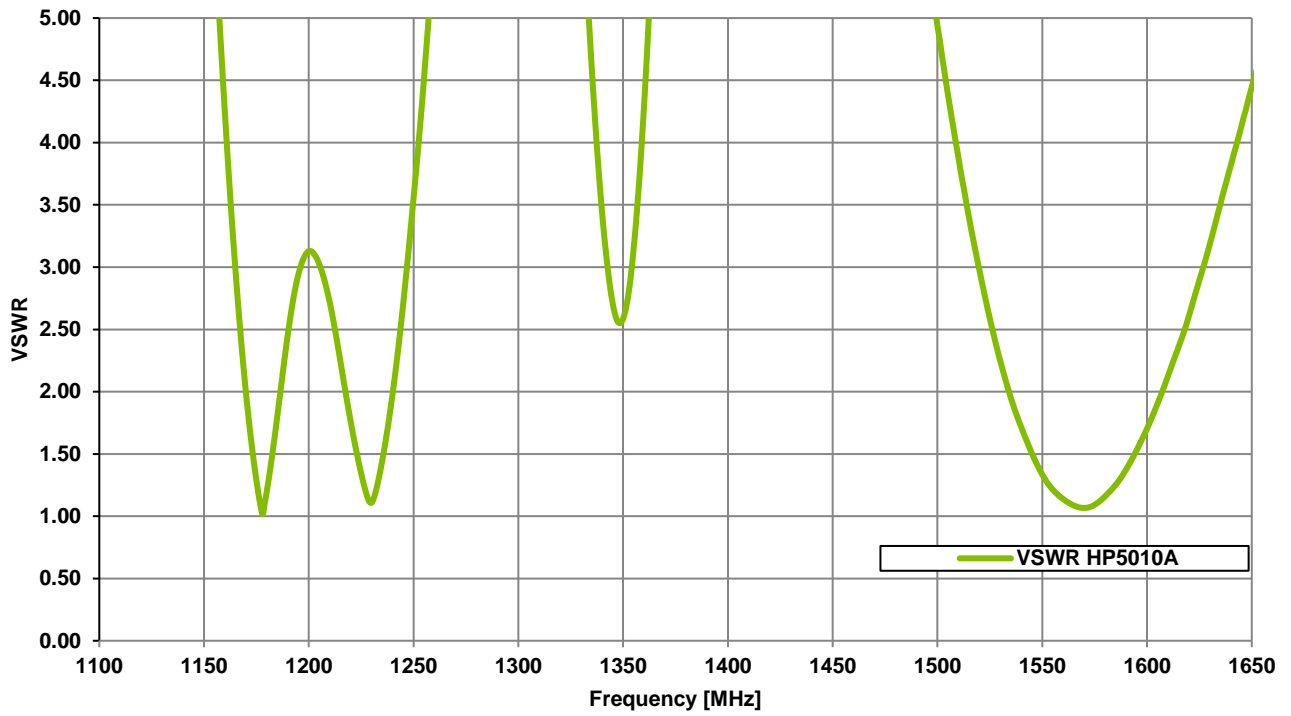

3.4 Efficiency

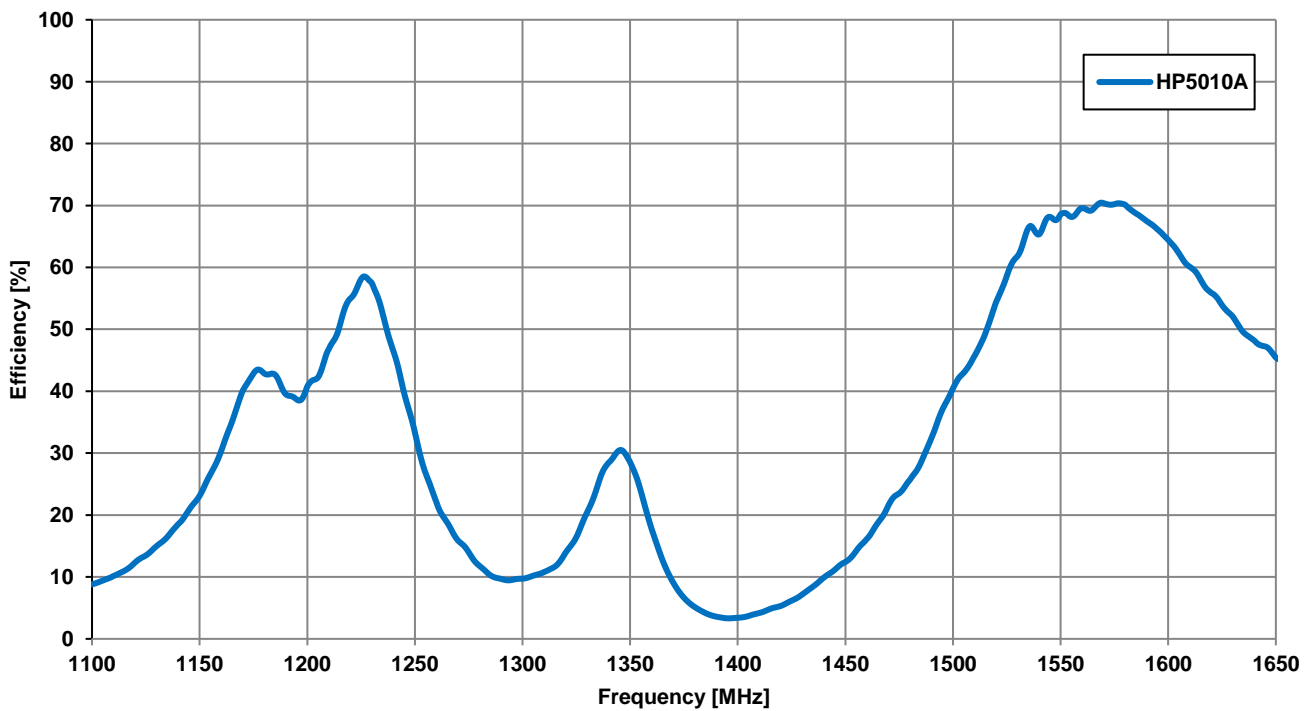

3.5 Peak Gain

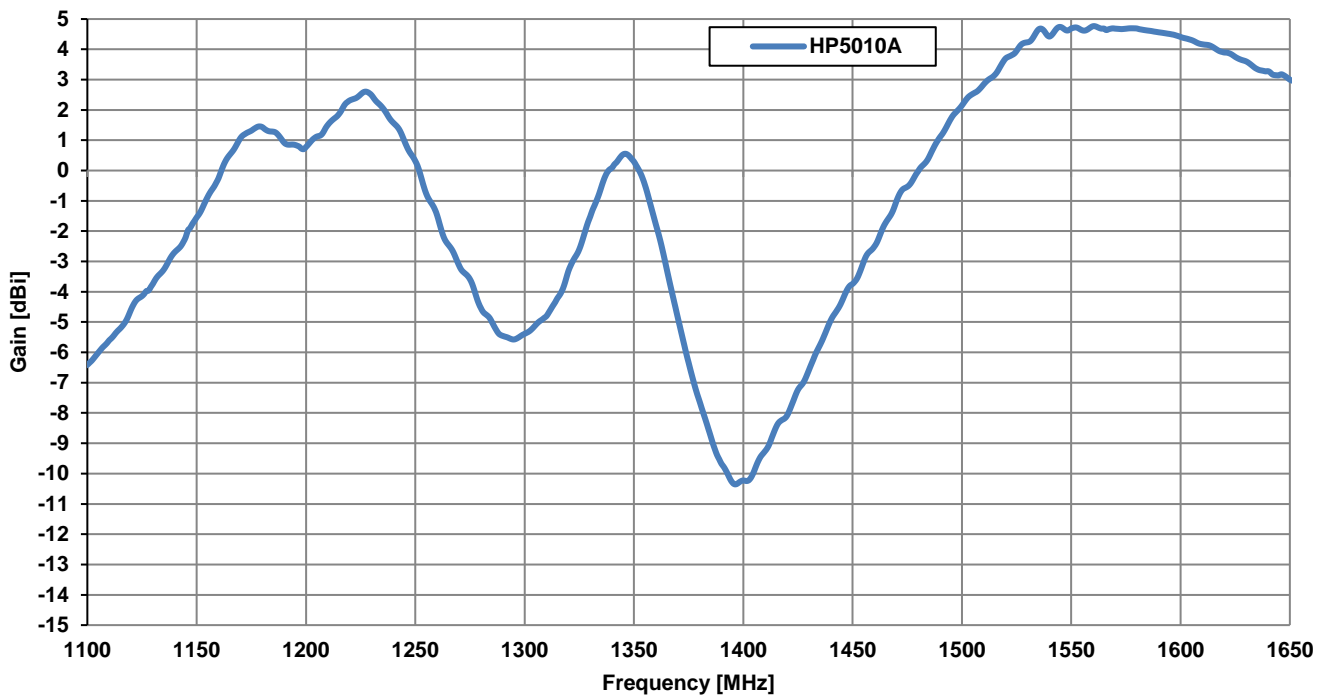

3.6 Average Gain

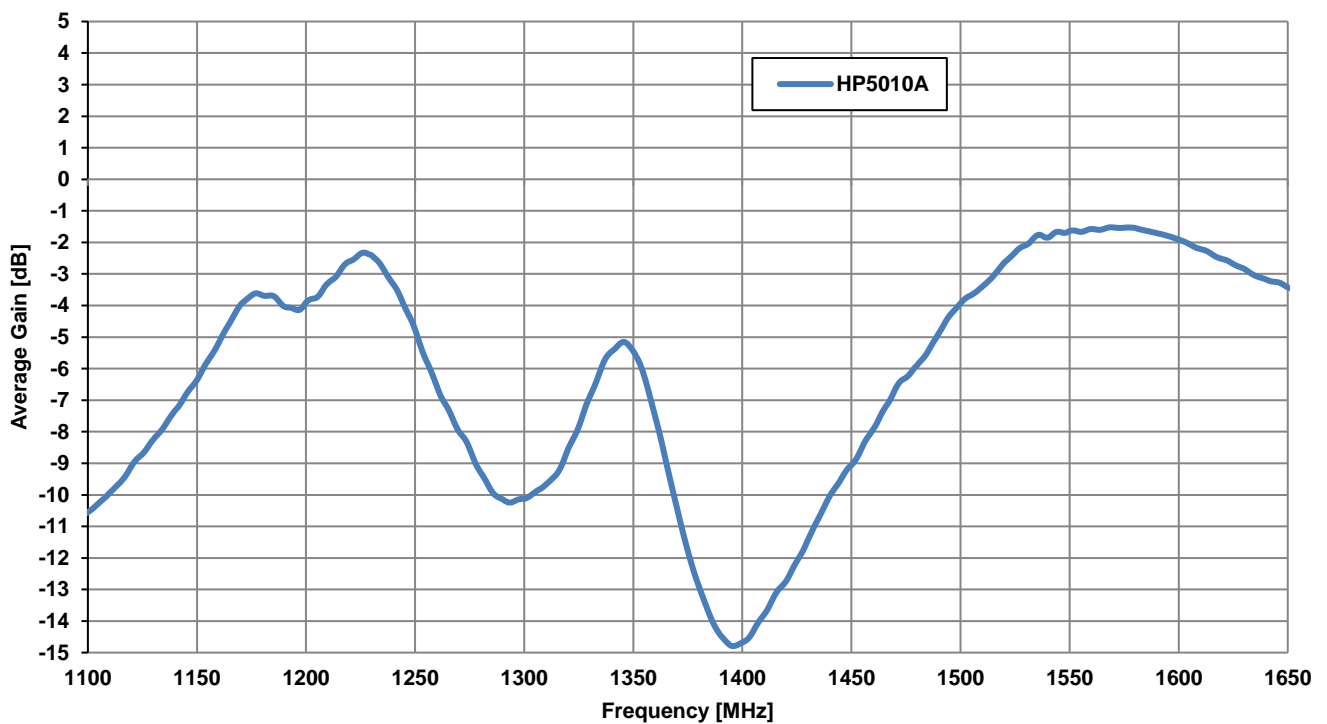

3.7 Axial Ratio @zenith vs Frequency

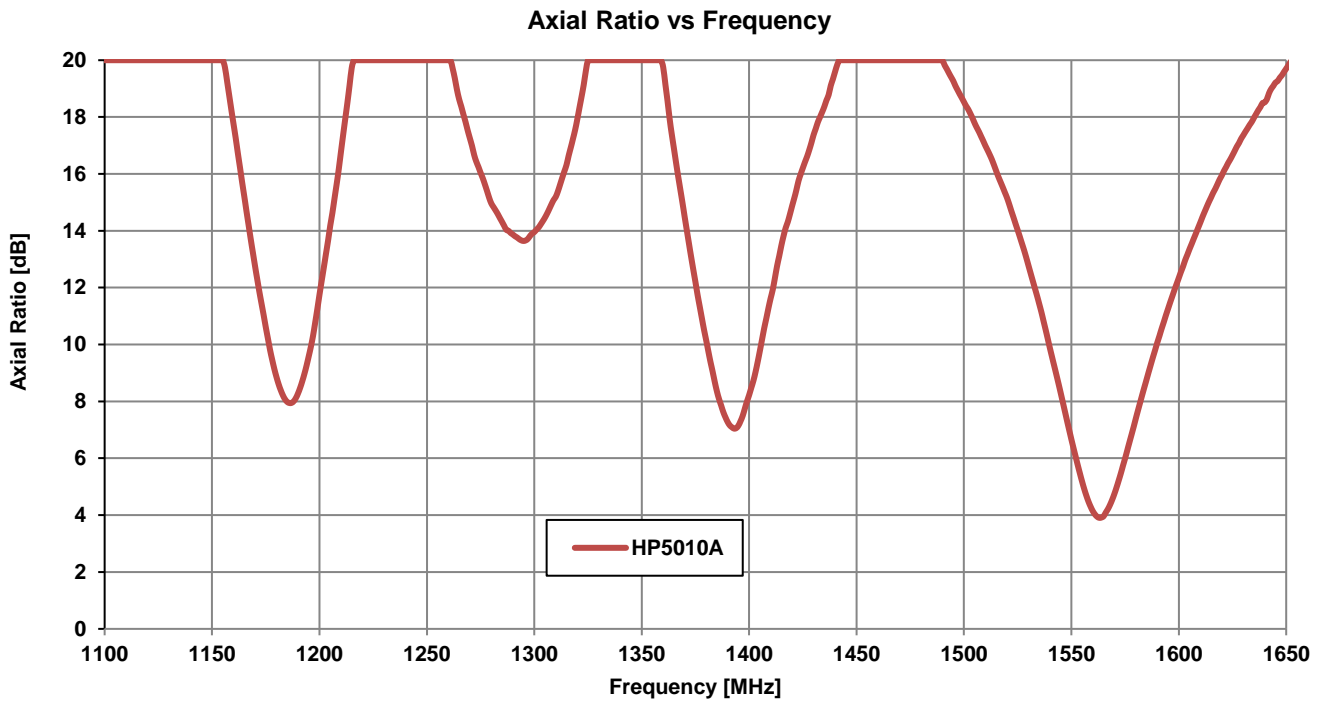

3.8 Axial Ratio @18deg vs Frequency

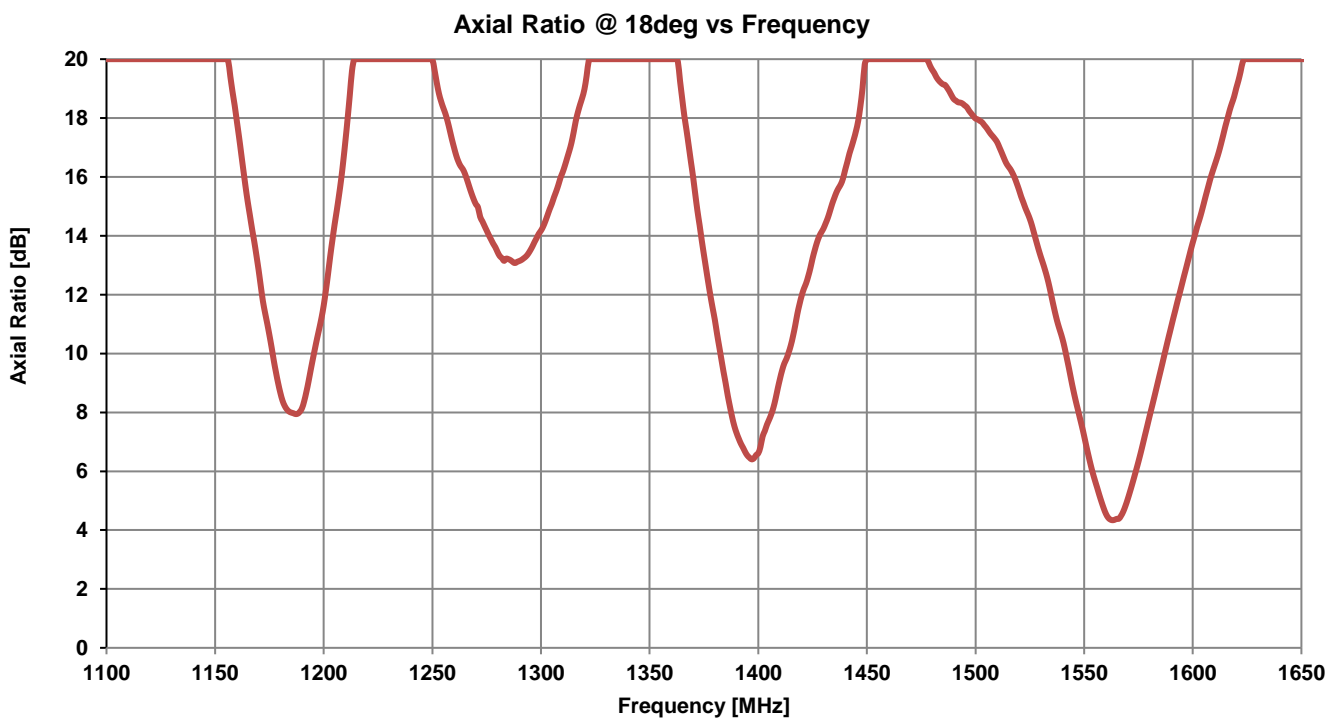

3.9 Axial Ratio vs Degrees

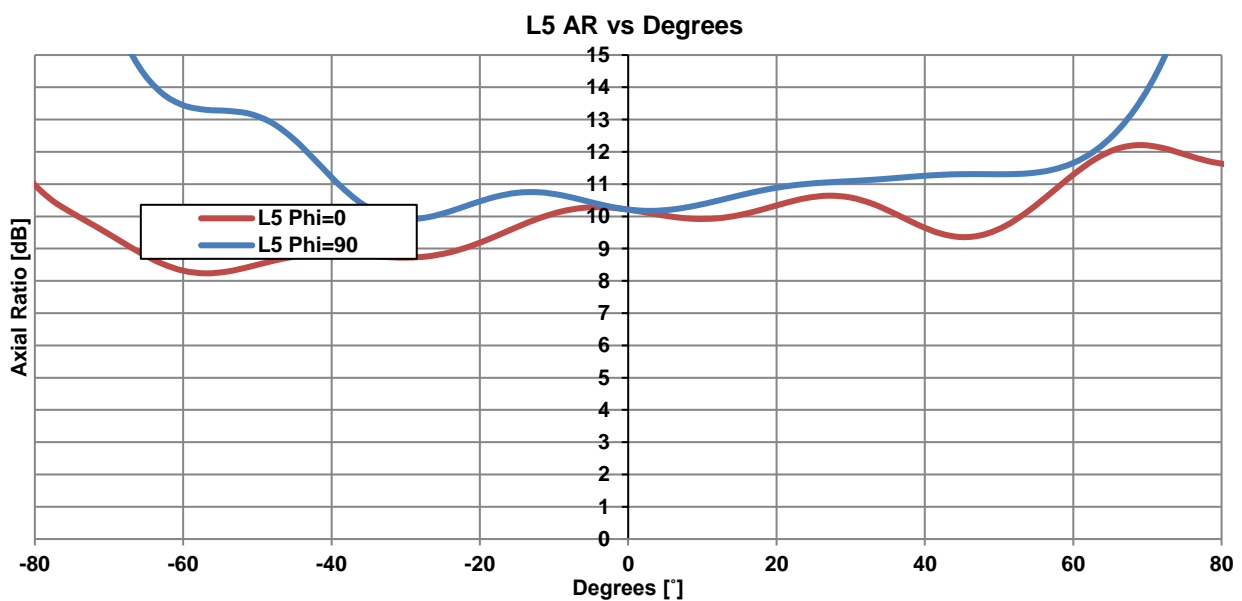
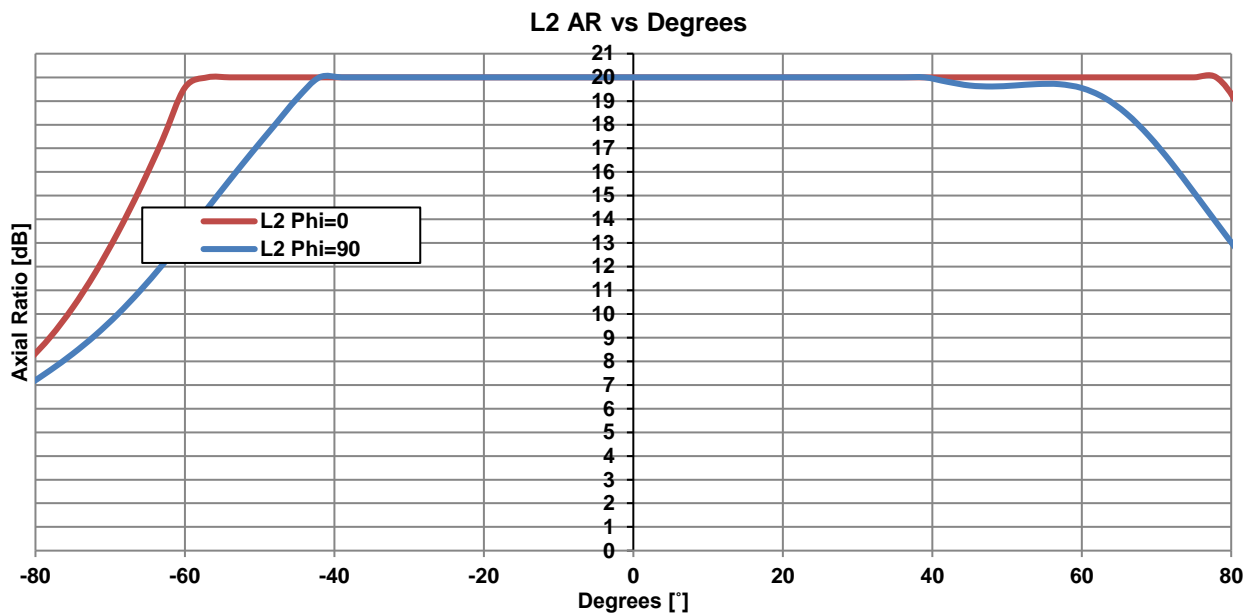
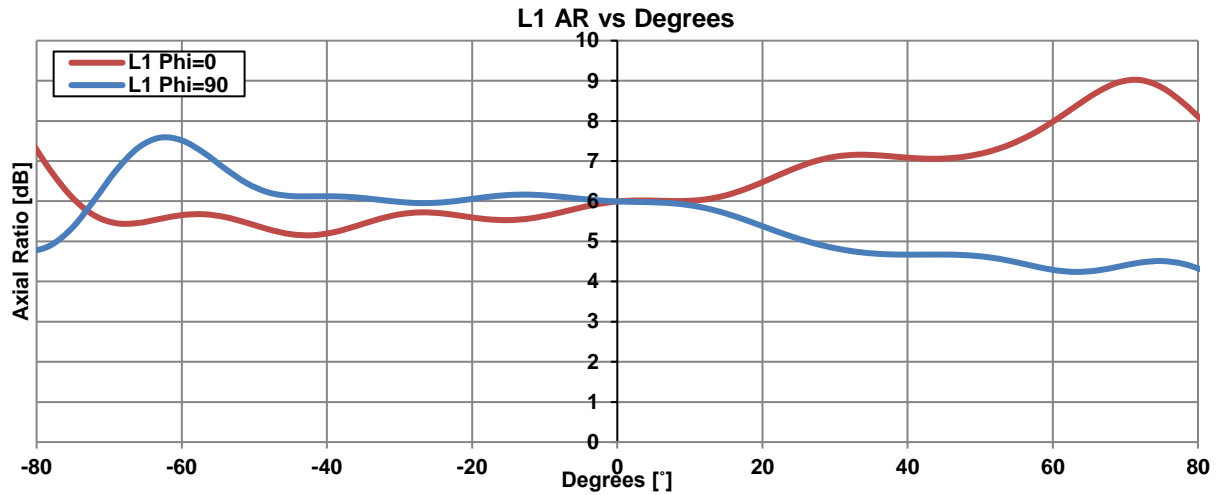

4. Radiation Patterns

4.1 Test Setup

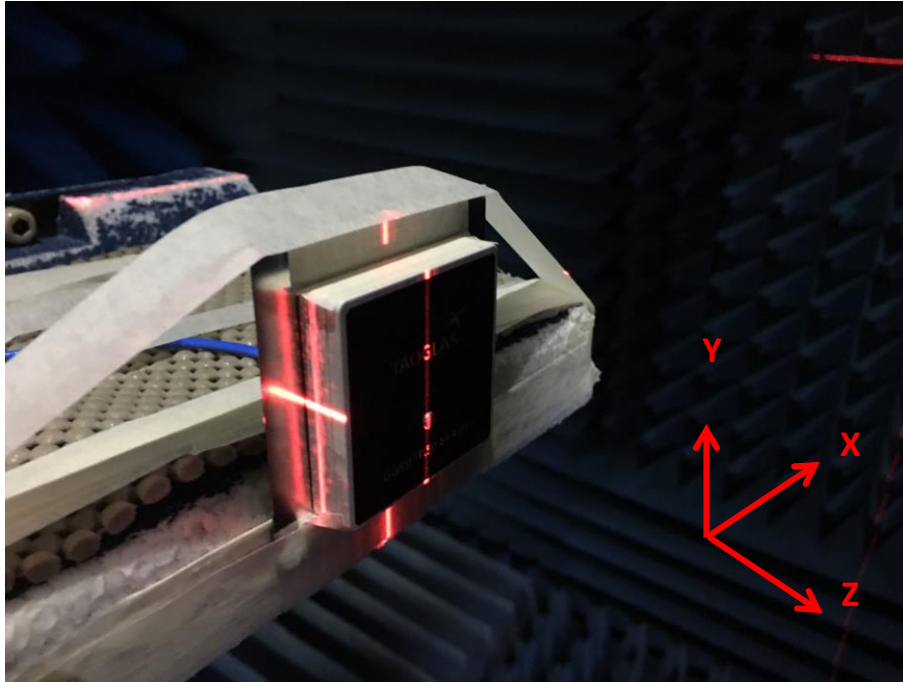

70*70mm Ground Plane

4.2 Radiation Patterns

1176.45MHz

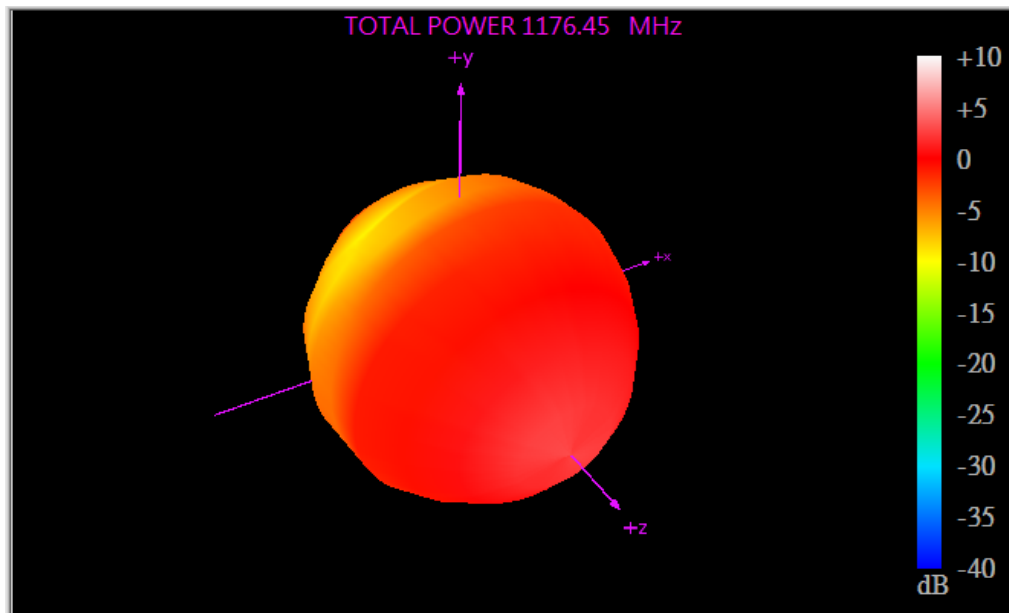

XY Plane XZ Plane YZ Plane

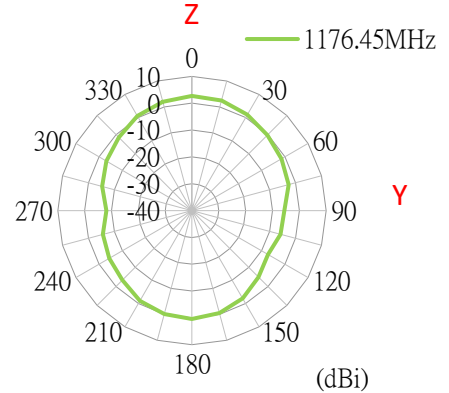
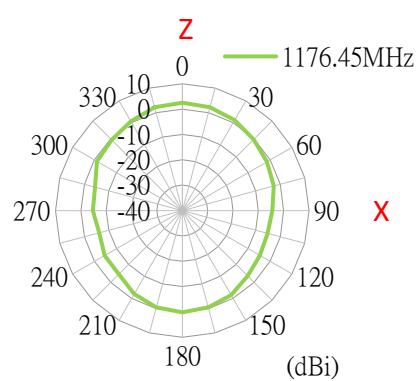
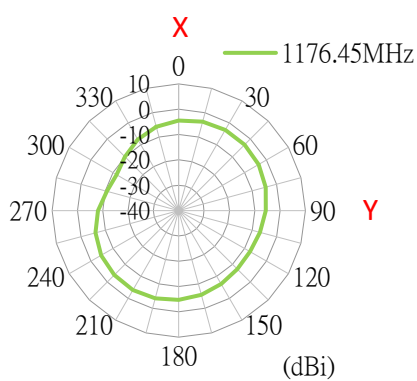

1227.6MHz

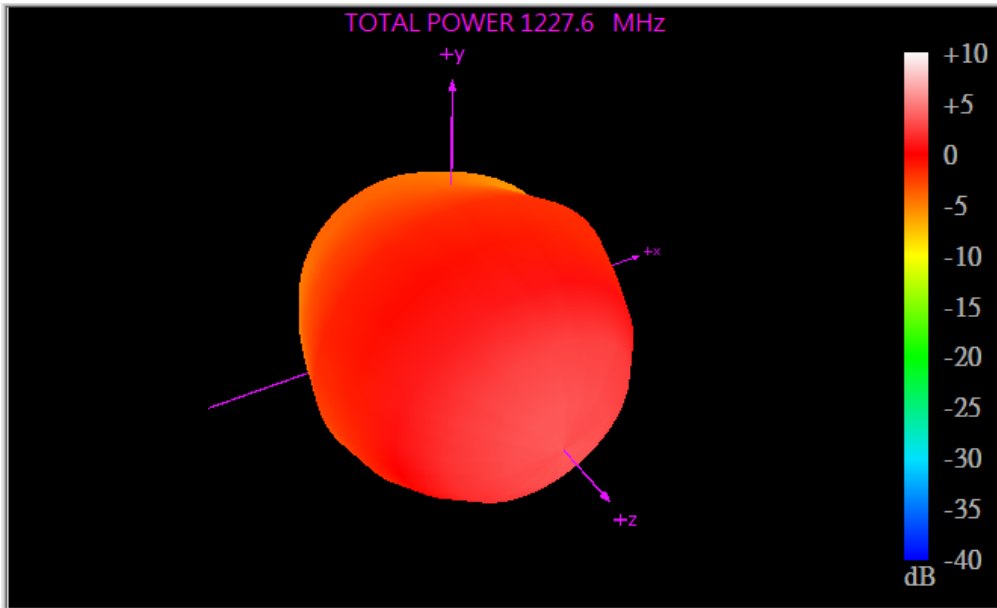

XY Plane

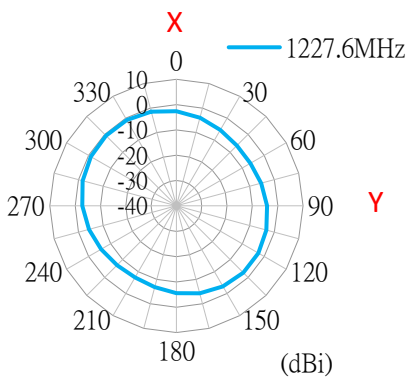

XZ Plane

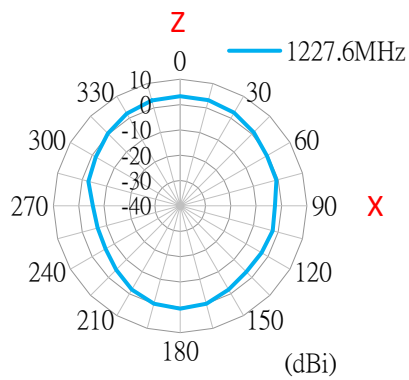

YZ Plane

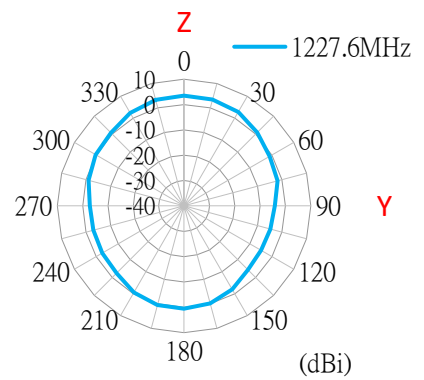

1561MHz

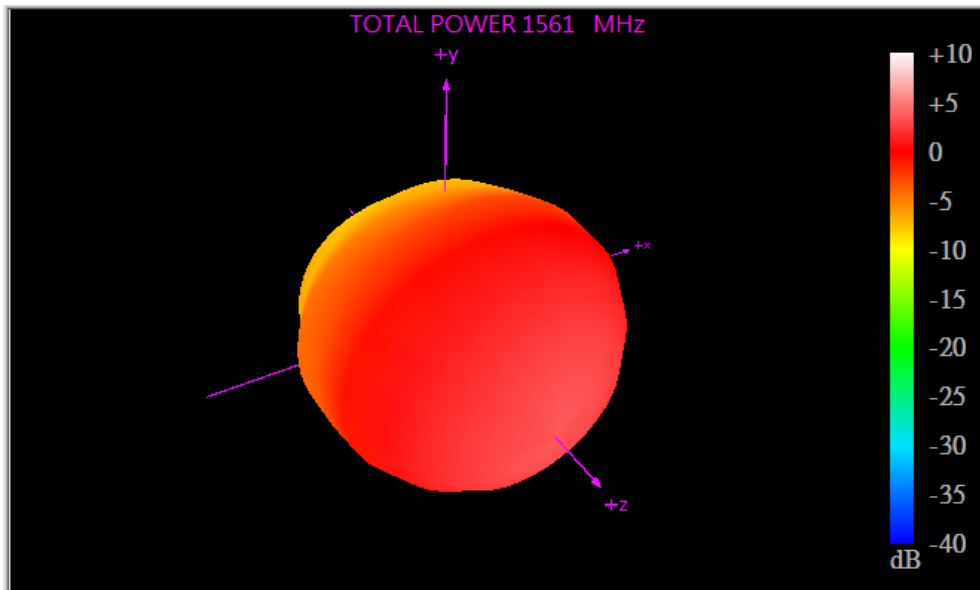

XY Plane

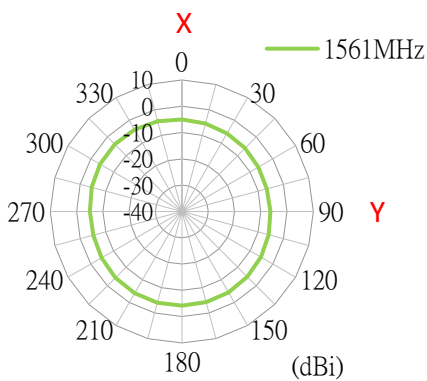

XZ Plane

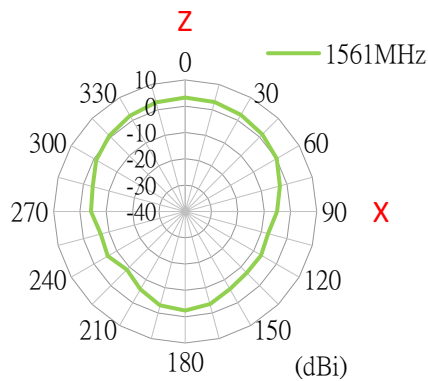

YZ Plane

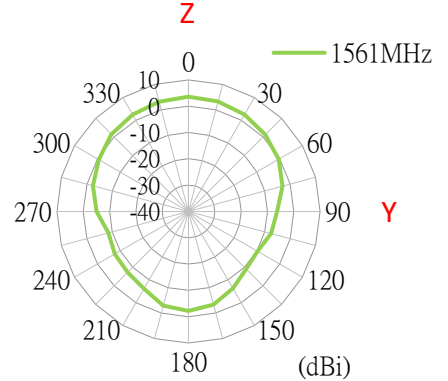

1575.42MHz

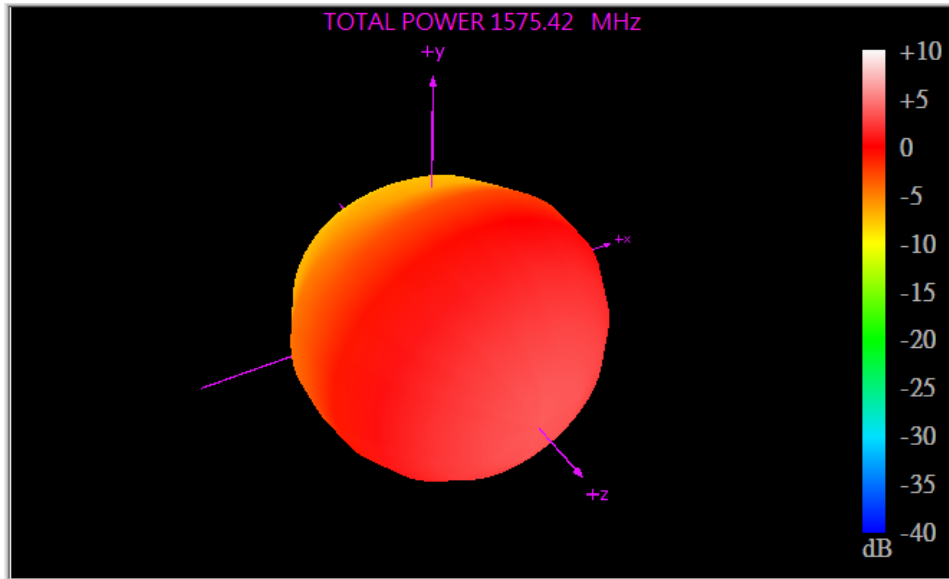

XY Plane XZ Plane YZ Plane

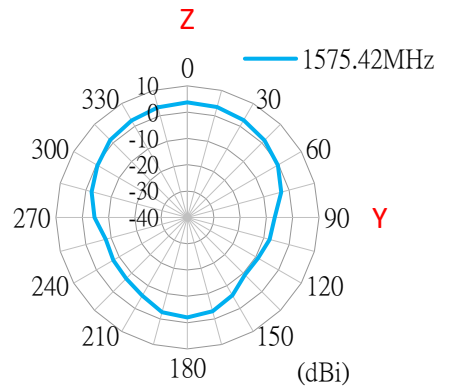
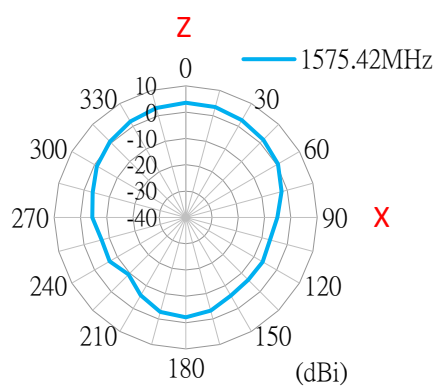
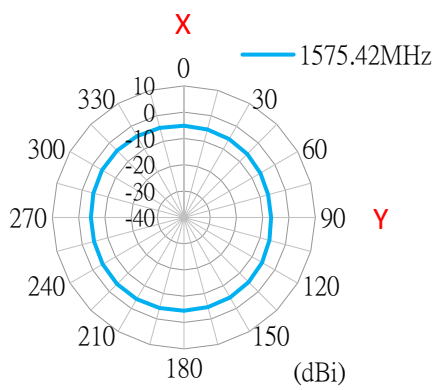

1602MHz

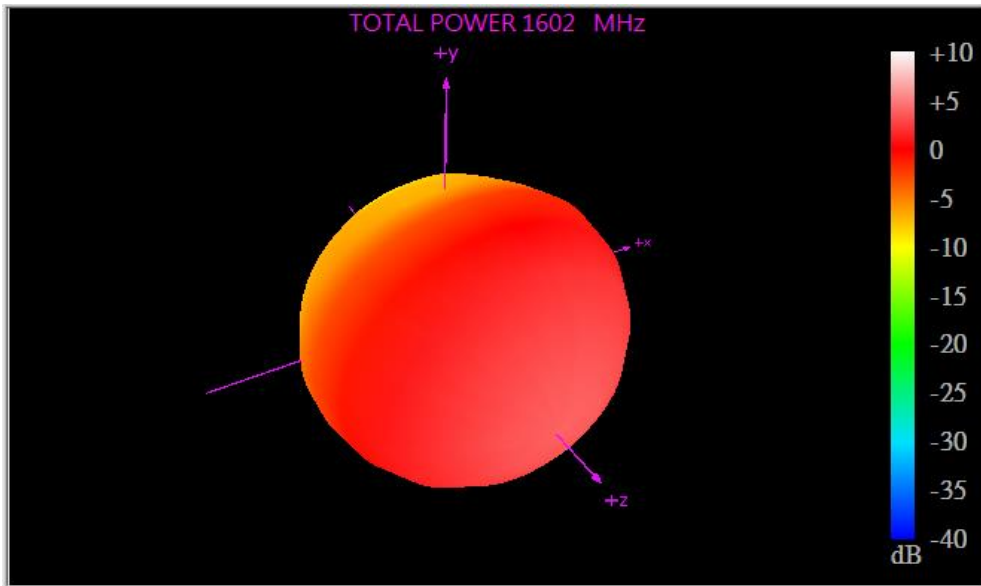

XY Plane XZ Plane YZ Plane

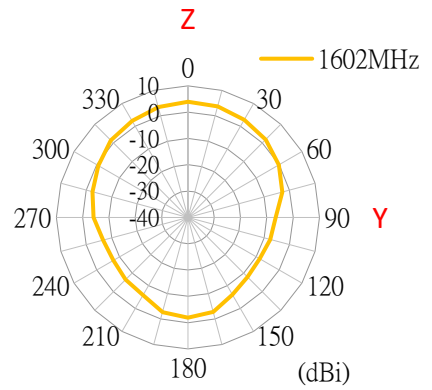
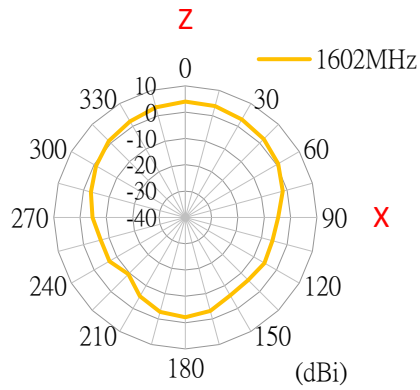
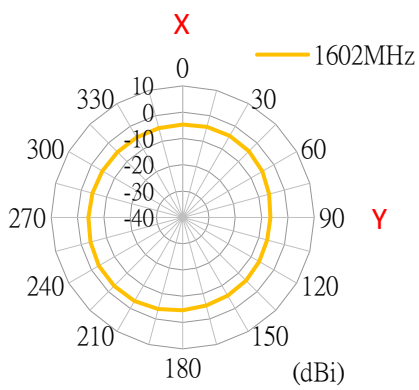

5. Mechanical Drawing (Units: mm)

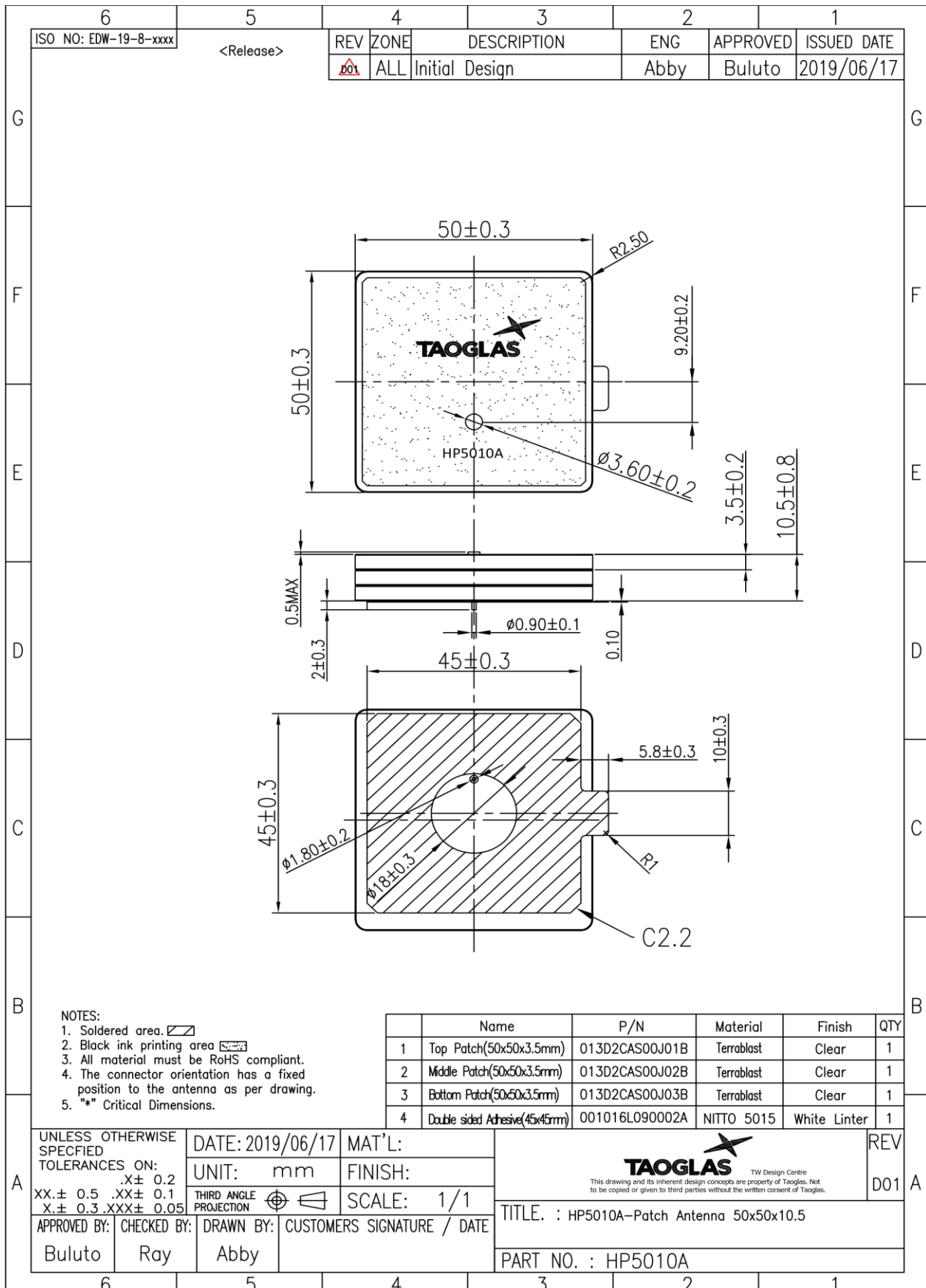

6. Soldering Recommendations

6.1 Automated Ferrochrome Soldering Machine

Soldering Temperature: 360-380°C

Soldering Duration: 3~4 seconds

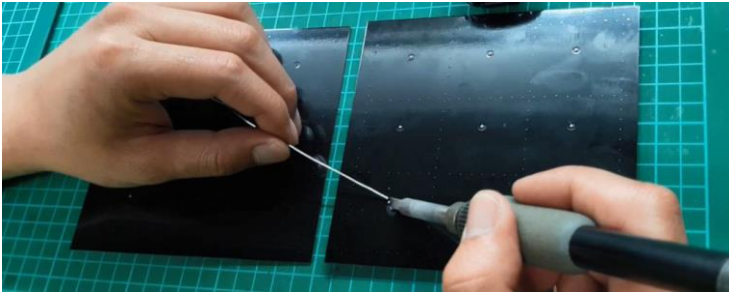

6.2 Automated Ferrochrome Soldering Machine

Soldering Temperature: 360-380°C

Soldering Duration: 3~4 seconds

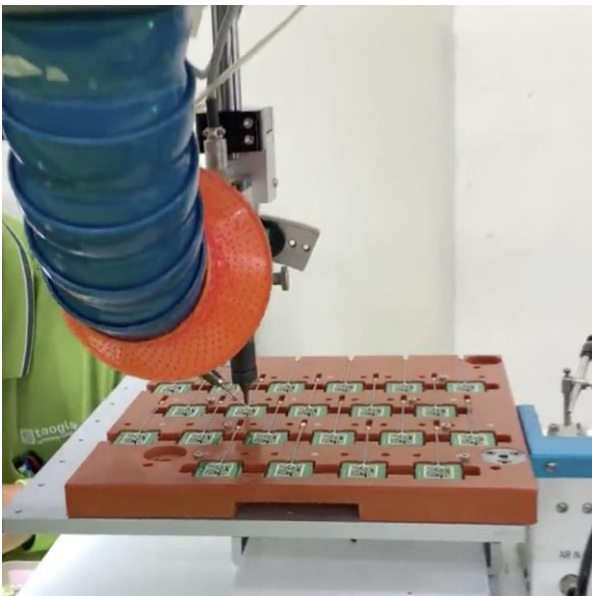

Please note that this process will require a one-time fixture to be made for each PCB design.

7. Packaging

8pcs HP5010A per Tray
Weight – 480g

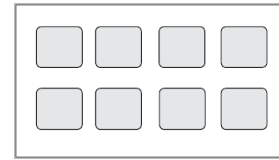

32pcs HP5010A per Small Box
Dimensions - 300*200*150mm
Weight – 2.1Kg

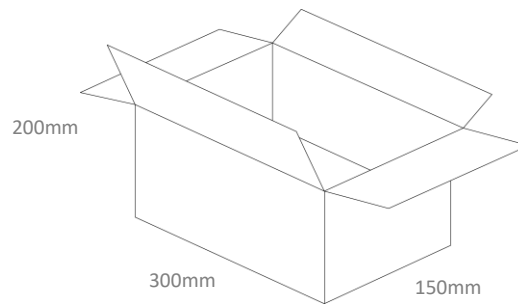

128pcs HP5010A per Carton
Dimensions - 410*320*320mm
Weight – 8.6Kg

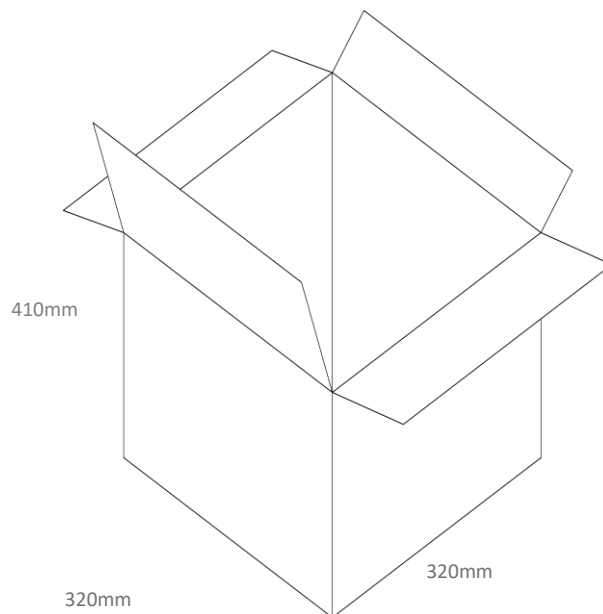

Changelog for the datasheet

SPE-19-8-090 – HP5010A

Revision: D (Current Version)

Date:	2020-12-07
Notes:	Updated Soldering Recommendations
Author:	Gary West

Previous Revisions

Revision: C

Date:	2020-03-20
Notes:	Updated RTK Table
Author:	Yu Kai Yeung

Revision: B

Date:	2020-01-09
Notes:	Updated Test data
Author:	Jack Conroy

Revision: A (Original First Release)

Date:	2019-06-25
Notes:	
Author:	Jack Conroy



TAOGLAS®

www.taoglas.com

