

Features

Regulated Converter

- Up to 1000 Watt fan-less power / 1200W boost
- Designed and made in Europe
- Efficiency exceeding 90% from 15% load
- Wide Operating temperature range -40...+80°C
- Certified to Industrial, and medical standards
- Analogue control & monitor function



RACM1200-V

1200 Watt
9" x 3.8"
Enclosed
Single Output



IEC/EN62368-1 certified
 UL62368-1 certified
 CAN/GSA-C22.2 No. 62368-1 certified
 IEC/EN60601-1 certified
 ANSI/AAMI ES60601-1 (pending)
 IEC/EN61558-1/2 compliant ⁽⁹⁾
 IEC61010-1/-2-201 compliant ⁽¹⁰⁾
 IEC/EN60601-1-2 compliant
 EN55032 compliant
 EN55035 compliant
 EN55024 compliant
 CB Report

Description

The RACM1200-V series is setting a new benchmark for compactness in the class of AC power supplies for reliable fan-less operation supporting long term system availability. A special baseplate cooled design supports heat transfer to allow up to 1000W continuous output power. Up to 1200 Watt output power is available for up to 10 seconds and in boost mode operation or for extended time with sufficient system airflow through the unit. A wide output voltage adjustment range and a combination of constant current limitation and hiccup mode settings makes the product multipurpose. The various analogue control and monitoring functions are accessible via connector. Optional firmware settings available on project base. The RACM1200-V Series can be limited to inherently fail-safe settings on request, using smart, controlled, fault-limiting functions. An adjustable 12V system fan output and a 1.5kVAC isolated auxiliary stand by output of 5VSB/1A are available to power the application's housekeeping functions. Peak efficiency reaches up to 95% and in standby mode, the unit is compliant to redesign requirements. The product holds worldwide safety files to medical, industrial and ITE standards along with electromagnetic compatibility compliance with class A immunity and class B emissions. All these features make the product one of the easiest to integrate modular power solutions in the industry.

Selection Guide

Part Number	Input Voltage Range [VAC]	Output Voltage Factory Set [VDC]	Output Voltage Range [VDC]	Max. Output Current [A]	Efficiency typ. ⁽¹⁾ [%]
RACM1200-24SAV/ENC	85-264	24	24-28	50A	95
RACM1200-48SAV/ENC	85-264	48	48-56	25A	95

Notes:

Note1: Efficiency is tested at nominal input and 40-60% load at +25°C ambient temperature

Model Numbering



Specifications (measured @ Ta= 25°C, nom. Vin, full load and after warm-up unless otherwise stated)

BASIC CHARACTERISTICS

Parameter	Condition	Min.	Typ.	Max.
Nominal Input Voltage	60/50Hz	100VAC		240VAC
Operating Range	47-63Hz	85VAC		264VAC
Input Current	according to CB report		11.5A	14A
Inrush Current	cold start at +25°C, 230VAC			25A
No load Power Consumption	main output REMOTE ON			2W
Standby Power	main output REMOTE OFF			1W
Minimum Load		0%		
Power Factor			refer to "Power Factor"	
Start-up Time	refer to "SIGNALS"	5VSB Aux.		900ms
		FAN		750ms
		main, 800W, 85-264VAC (-25°C to +70°C)		750ms
Hold-up Time	800W	20ms		
Output Ripple and Noise ⁽²⁾	20MHz BW, valid for MAIN, 5VSB, FAN			1% of nom. Vout

Notes:

Note2: Measurements are made with a 0.1µF MLCC & 10µF E-cap in parallel across output. (low ESR)

RACM1200-24SAV/ENC and RACM1200-48SAV/ENC

Efficiency vs. Load

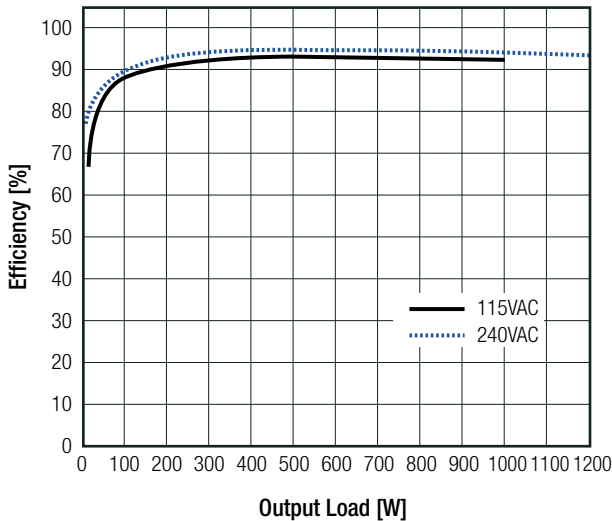

Power Factor

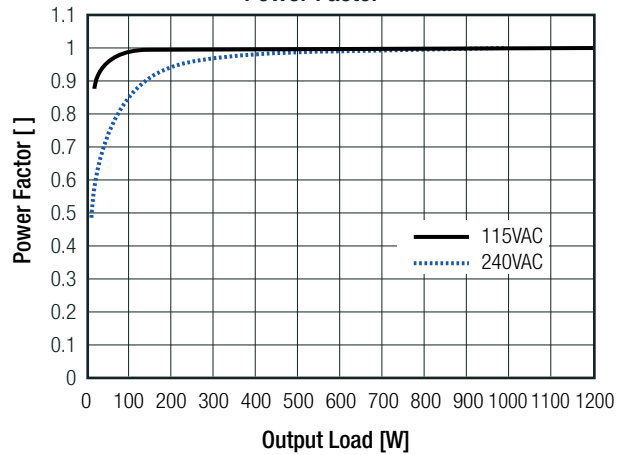

Power Dissipation

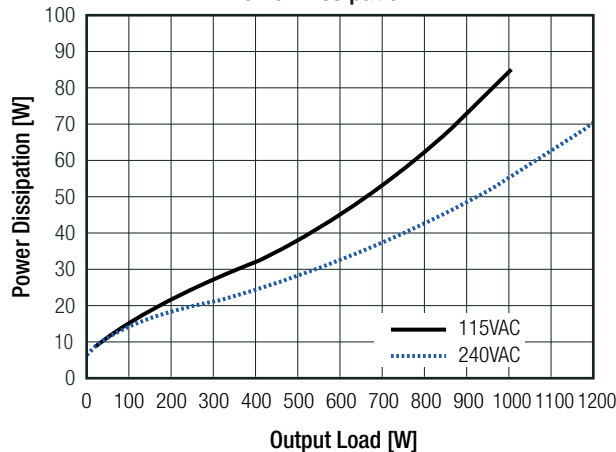

Specifications (measured @ Ta= 25°C, nom. Vin, full load and after warm-up unless otherwise stated)

REGULATIONS			
Parameter	Condition		Value
Set Point Accuracy	MAIN		±1.0% max.
	5VSB / FAN		±5.0% max.
Total Regulation	line, load and temperature drift	MAIN & FAN	±2.0% max.
		5VSB Aux.	±5.0% max.

ADDITIONAL FEATURES					
Parameter	Condition		Min.	Typ.	Max.
5VSB Stand By Output Voltage	always on				5VDC
5VSB Stand By Output Current					
Output Voltage Adjustability	tactile button push up/down	24Vout type (100mV steps) 48Vout type (200mV steps)	24VDC 48VDC		28VDC 56VDC
Remote ON/OFF	maximum allowed voltage referenced to SIGNAL RTN				5VDC
FAN Output Voltage adjustment via FAN ADJ Pin #6 @ TTL levels	CTRL= 2.5VDC CTRL= 2.2VDC...0VDC or open		5VDC	OFF	12VDC
FAN Output Current	ON/OFF with main channel	24Vout 48Vout			1A 0.9A
"Remote Sense"	differential mode, cable loss compensation				500mV
LED Signals (Single RGB LED)	Green continuously Blue intermittent (30% on) Green intermittent (50% on) Green / Red alternatively (50%:50%) Red intermittent (50% on) Red / Blue alternatively (50%:50%) Red continuously		PSU-Good: PSU in standard operation mode STBY: Standby mode; Main Output OFF via REMOTE signal DC-LOW: Signal: {75%<V _{OUT} <95%} drives nonlinear loads OTW: Over temperature warning; Output normal operation OTP: Over temperature, Output OFF, self-recovering after cooling OLP: Over load protection: Output OFF, auto-recovery DC-Fail: Output latch-OFF, permanent fault until AC-reset		

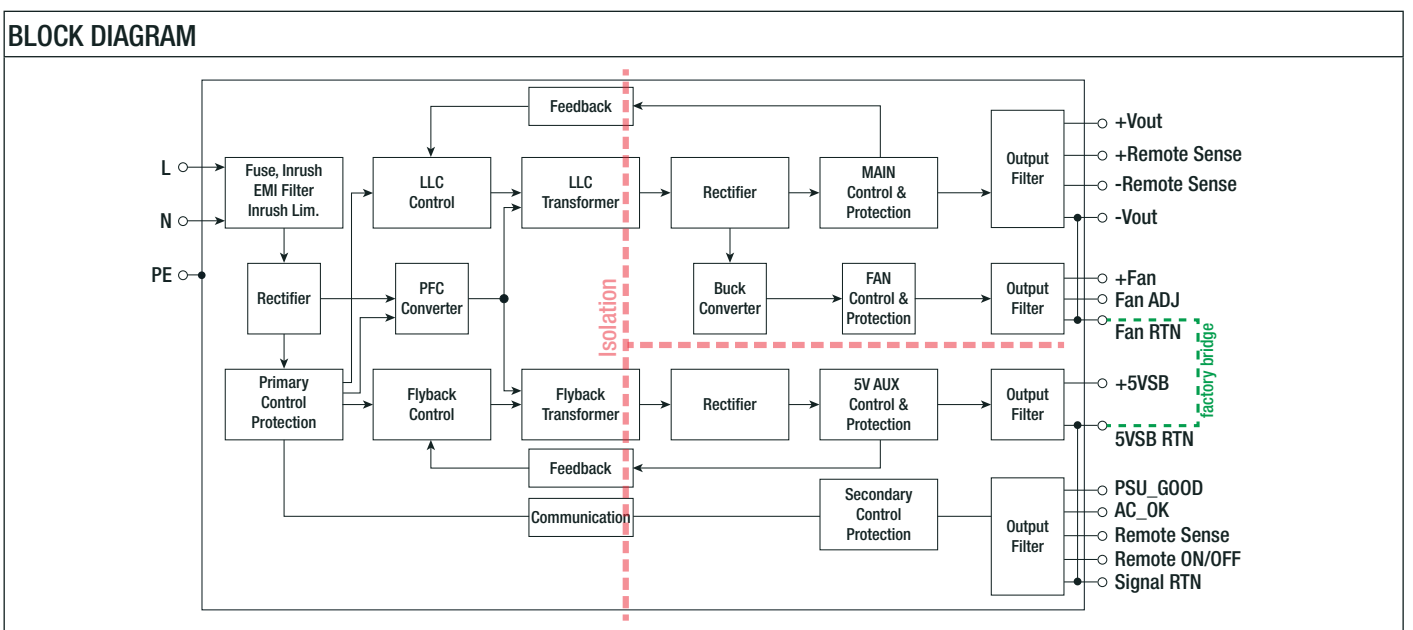
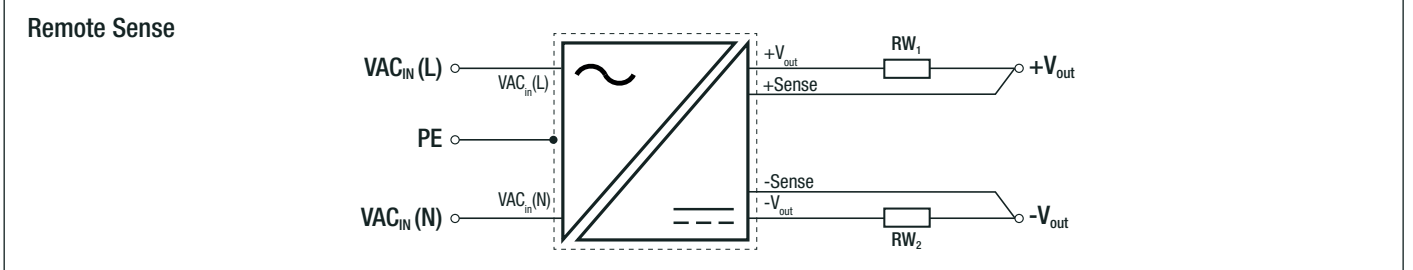

Specifications (measured @ Ta= 25°C, nom. Vin, full load and after warm-up unless otherwise stated)

SIGNALS

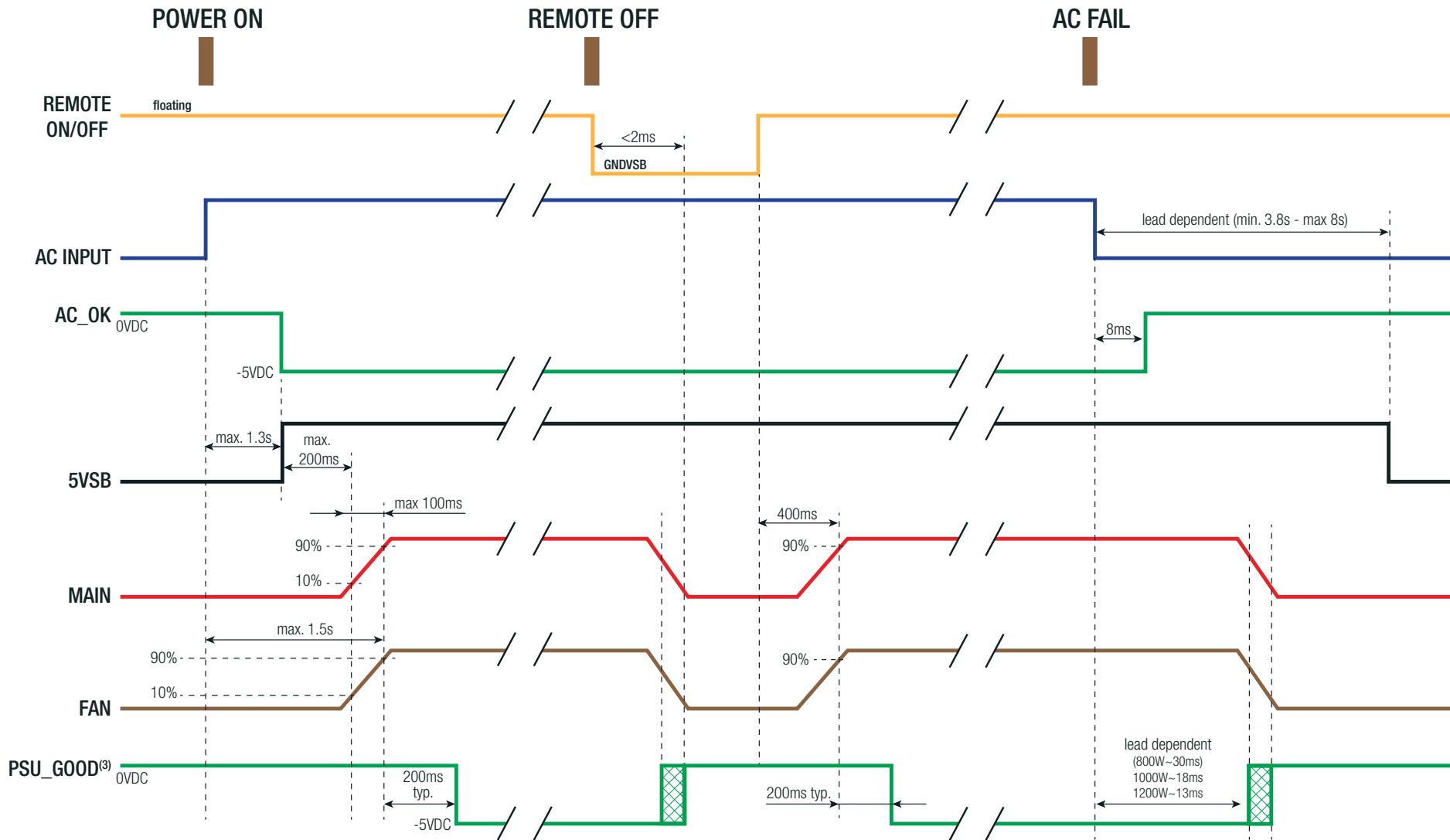

Notes:

Note3: The outputs are open-drain and require an external pull-up resistor to keep the output in a defined logic state

Specifications (measured @ Ta= 25°C, nom. Vin, full load and after warm-up unless otherwise stated)

Signal Description

Remote ON/OFF

Pin position - #17 (CON3 connector). Pin type – input pin, referenced to ‘SIGNAL RTN’ ground. Max. allowed voltage level: 5VDC. Leave this signal ‘open’ (not connected) for always-ON operation. Connect to ‘SIGNAL RTN’ for ‘always-OFF’ operation.
NOTE: Typically, use external mechanical switch between pins #17 and #18 of CON3 connector to control the unit’s on/off functionality.

Remote Sense Activation

Pin position - #15 (CON3 connector). Pin type – input pin, referenced to ‘SIGNAL RTN’ ground. Max. allowed voltage level: 5VDC. Leave this signal ‘open’ (not connected) for internal output sensing functionality. Connect to ‘SIGNAL RTN’ for activating the remote main-output voltage sensing. When this functionality is set active, the pins ‘Remote Sense +’ (pin #10) and ‘Remote Sense RTN’ (pin #9) must be connected to the load points where customer wants to remotely monitor the main output amplitude. When this functionality shall be left inactive (default state), the remote sensing lines ‘Remote Sense+’ and ‘Remote Sense RTN’ must stay unconnected.
NOTE: Typically, activating this feature comes together with an external wired sense line connections to the load point, which is expected to be done at process of installing the unit within a system.

AC_OK

Pin position - #13 (CON3 connector). Pin type – open-collector output pin, referenced to ‘SIGNAL RTN’ ground. Minimal pull-up resistor: 5kOhm. Maximal pull-up rail voltage: 5VDC. Maximal output current (+25°C): 1mA. Active status: low. Output voltage at active-low state (+25°C): max. 0.4V. Recommended usage: use pull-up resistor of 10kOhm to +5VSB voltage rail. The ‘AC_OK’ signal is set active-low state, when input AC line is more than typ.80VACrms. The ‘AC_OK’ signal is set inactive-high state, when input AC line is less than typ.70VACrms.

PSU_GOOD

Pin position - #14 (CON3 connector). Pin type – open-collector output pin, referenced to ‘SIGNAL RTN’ ground. Minimal pull-up resistor: 5kOhm. Maximal pull-up rail voltage: 5VDC. Maximal output current (+25°C): 1mA. Active status: low. Output voltage at active-low state (+25°C): max. 0.4V. Recommended usage: use pull-up resistor of 10kOhm to +5VSB voltage. The ‘PSU_OK’ signal is set active-low state, when 3 conditions are met: outputs are present, temperature is within limits (less than warning temperature) and no internal failure is activated (e.g. OTP, OCP, OLP, etc.) The ‘PSU_OK’ signal is set inactive-high state, when at least one of the above 3 conditions is not met.

PROTECTIONS			
Parameter	Type	Value	
Internal Input Fuse	L and N (dual fusing)	2x T12A/250VAC	
Over Voltage Category (OVC)	IEC62368-1; IEC61010-1 ⁽¹⁰⁾	OVCII	
	IEC62477-1; up to 2000m	OVCIII	
Over Temperature Protection (OTP)	detected on internal sensors	auto recovery after cooling down to 70°C (±5°C)	
Over Temperature Warning		LED= green/red alternatively , DC low	
Class of Equipment	with PE	Class I	
Isolation Voltage ⁽⁴⁾	1 minute	I/P to O/P (unit)	4kVAC
		I/P and O/P to chassis	1.5kVAC
		O/P to 5VSB & signals; 5VSB & signals to chassis (when factory bridge #7 to #16 is removed)	1.5kVAC
Insulation Grade	I/P to O/P	reinforced	
Earth Leakage Current		NC: 300µA max.; SFC: 1mA	
Patient Leakage		NC: 100µA max.; SFC: 500µA	
Means of Protection		2MOPP	
Medical Device Classification		built-in, suitable for Type BF rated medical applications	
<p>Notes:</p> <p>Note4: For repeat Hi-Pot testing, reduce the time and/or the test voltage</p>			

continued on next page

Specifications (measured @ Ta= 25°C, nom. Vin, full load and after warm-up unless otherwise stated)

PROTECTIONS MAIN OUTPUT			
Parameter	Type		Value
Short Circuit Protection (SCP)			auto recovery, hiccup mode
Over Voltage Protection (OVP)	no reverse overvoltage protection	24Vout 48Vout	29.5VDC typ., Latch OFF 59VDC typ., Latch OFF
Over Current Protection (OCP)	refer to "Over Current Protection"		power limiting (>75% Vout), Hiccup Mode

Over Current Protection

The graph plots output voltage (Vout) against output current (Iout). The y-axis has markers for max. Vout, nom. Vout, and 75% Vout. The x-axis has markers for 85% and 100% of the nominal current. The operating region is divided into a 'constant power' region (0% to 85% Iout) and a 'constant current' region (85% to 100% Iout). A shaded area below the 75% Vout line is labeled 'Over Current Protection (Hiccup Mode)'.

PROTECTIONS FAN			
Parameter	Type		Value
Short Circuit Protection (SCP)			auto recovery
Over Voltage Protection (OVP)	if OVP is activated, all outputs will shut off		auto recovery, hiccup mode
Over Current Protection (OCP)			auto recovery, power limitation

PROTECTIONS 5VSB			
Parameter	Type		Value
Short Circuit Protection (SCP)			auto recovery, hiccup mode
Over Voltage Protection (OVP)	if any protection is activated, all outputs will shut off		auto recovery, hiccup mode
Over Current Protection (OCP)			auto recovery, hiccup mode

ENVIRONMENTAL			
Parameter	Condition		Value
Operating Temperature Range	refer to "Main Output Nominal Power Rating vs. Ambient Temperature"	T _{AMB} and T _{BASE} temperature max. start-up temperature	-40°C to +80°C +70°C typ.
Operating Altitude ⁽⁵⁾	IEC/EN62368-1 ANSI/AAMI/EN60601-1 (pending)		5000m 4000m
Operating Humidity	non-condensing		95% RH max.
IP Rating			IP20
Pollution Degree			PD2
Design Lifetime	+40°C (reference point)		88 x 10 ³ hours

Notes:

Note5: Recognized by safety agency for safe operation up to 5000m. High altitude operation above 2000m may impact the performance and lifetime. Please contact RECOM tech support for advice.

continued on next page

Specifications (measured @ $T_a = 25^\circ\text{C}$, nom. V_{in} , full load and after warm-up unless otherwise stated)

Suggested Power Rating for main Output

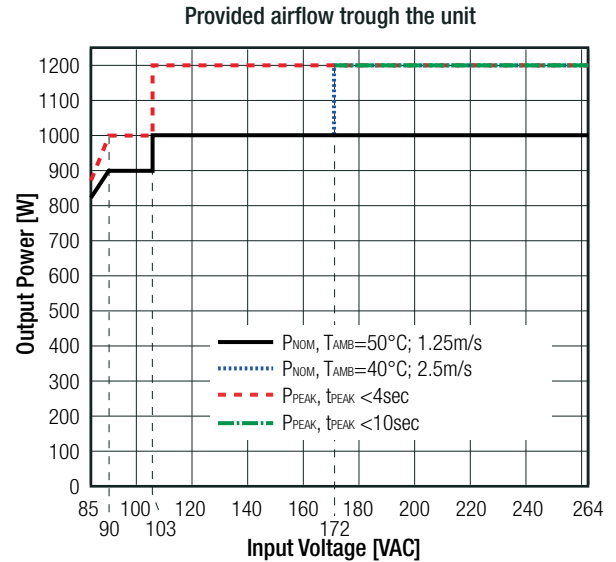
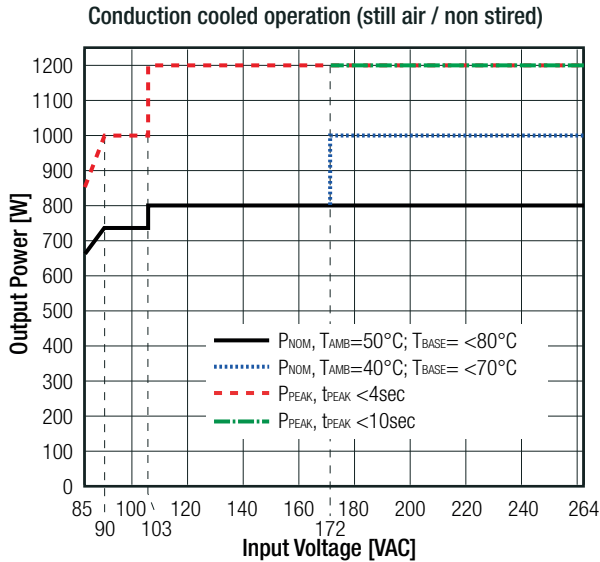

The units were evaluated to safety files for nominal input voltages 100-240VAC; including a tolerance band of $\pm 10\%$, with a specified maximum T_{BASE} of 80°C for full load rating with 50°C T_{AMB} and up to 80°C T_{AMB} at reduced output power. T_{BASE} at reference point (see "thermal reference point") shall not exceed 70°C , 80°C or 90°C depending on the condition as per derating graph.

Peak power was evaluated at 60s duty cycle period for safety files. Without externally provided forced airflow, continuous output power needs to be limited to 1000W at high input voltage range and $T_{AMB} < 40^\circ\text{C}$ with a $T_{BASE} < 70^\circ\text{C}$. With forced airflow of 2.5m/s 1200W continuous boost power at high input voltage range ($> 172\text{V}$) is available.

Main Output Nominal Power Rating vs. Ambient Temperature

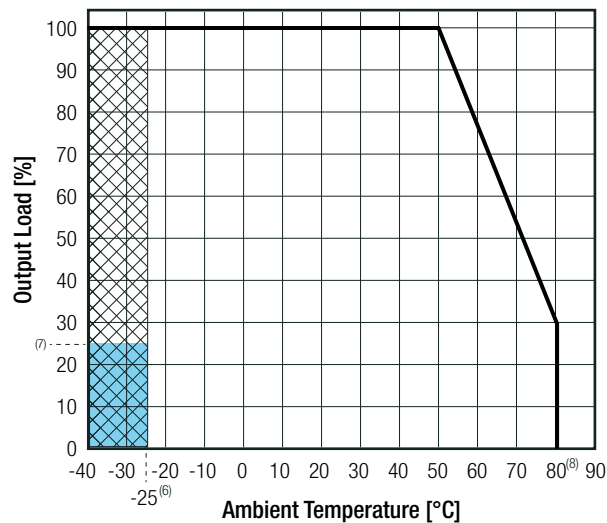

Notes:

Note6: Below $T_{AMB} - 25^\circ\text{C}$ some specifications may not be met

Note7: Output Power at $T_{AMB} = -40^\circ\text{C}$ cold start $\leq 250\text{W}$.

Note8: At $T_{AMB} + 80^\circ\text{C}$ and 30% load, the maximum allowed baseplate temperature $T_{BASE} \leq 90^\circ\text{C}$ measured on thermal reference point. Refer to "thermal reference point"

Specifications (measured @ Ta= 25°C, nom. Vin, full load and after warm-up unless otherwise stated)

PEAK LOAD CAPABILITY

PEAK POWER IS NOT AVAILABLE DURING START UP PHASE!

Exceeding power ratings, may reduce the lifetime and lead to OLP power limitation or OTP temperature shut off. Inherently safe unit set up for more strict automatic power limitation is available on request per firmware setting option. Peak Power duty cycle plus recovery period shall not exceed 90% of the average nominal power for repetitive load conditions.

Peak Load Calculation

$$P_{nom} * 0.9 * (t_{rec} + t_{peak}) \geq P_{peak} * t_{peak} + P_{rec} * t_{rec}; [t_{rec} + t_{peak} \geq 60s]$$

P_{nom}	... nominal power output (as per derating graph)	[W]
P_r	... applied recovery power	[W]
P_p	... applied peak power	[W]
t_r	... recovery time	[s]
t_p	... peak time	[s]
	$V_{IN} < 172VAC = 4s$	[s]
	$V_{IN} \geq 172VAC-264VAC = 10s$	[s]

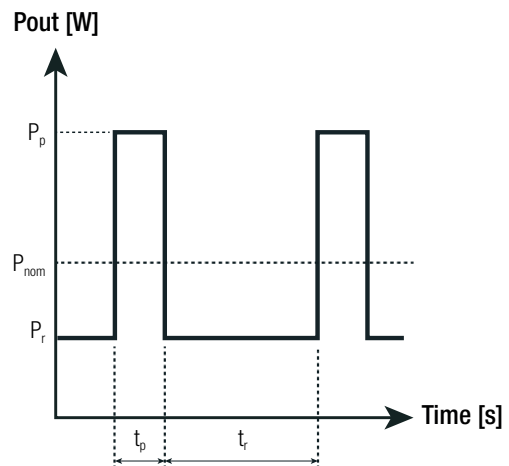

SAFETY AND CERTIFICATIONS

Certificate Type (Safety)	Report Number	Standard
Audio/video, information and communication technology equipment- Safety requirements (CB)	T223-0765/20	IEC62368-1:2014 2nd Edition
Audio/video, information and communication technology equipment - Safety requirements		EN62368-1:2014 + A11:2017
Audio/video, information and communication technology equipment- Safety requirements (CB)	E224736-A6006-UL	UL62368-1:2014
Audio/video, information and communication technology equipment - Safety requirements		CAN/CSA-C22.2 No. 62368-1:2014
Medical Electric Equipment, General Requirements for Safety and Essential Performance	pending	ANSI/AAMI ES60601-1:2005 CAN/CSA-C22.2 No. 60601:14
Medical Electric Equipment, General Requirements for Safety and Essential Performance (CB)	T223-0766/20	IEC60601-1:2005, 3rd Edition + AM1:2012
Medical Electric Equipment, General Requirements for Safety and Essential Performance		EN60601-1:2006 + A1:2013
Safety of transformers, reactors, power supply units and combinations thereof - Part 1: General requirements and tests	compliant ⁽⁹⁾	IEC61558-1:2005, 2nd Edition + A1:2009 EN61558-1:2005 + A1:2009
Electrical Equipment For Measurement, Control, and Laboratory Use; Part 1: General Requirements	compliant ⁽¹⁰⁾	IEC61010-1/-2-201
RoHS2		RoHS 2011/65/EU + AM2015/863

Notes:

Note9: Insulation inside transformer meets requirements for insulation and overload per IEC61558-1 (tested in T223-0765/20)

Note10: Creepage and clearance according to IEC61010-1/-2-201 (tested in T223-0766/20)

continued on next page

Specifications (measured @ Ta= 25°C, nom. Vin, full load and after warm-up unless otherwise stated)

EMC Compliance (Medical)		
Medical electrical equipment - Part 1-2: General requirements for basic safety and essential performance - Collateral standard: Electromagnetic compatibility - Requirements and tests		IEC60601-1-2:2014, Class B EN60601-1-2:2015, Class B
Industrial, scientific and medical equipment - Radio frequency disturbance characteristics - Limits and methods of measurement		EN55011, Class B
Industrial, scientific and medical equipment - Radio-frequency disturbance characteristics - Limits and methods of measurement ⁽¹²⁾		CISPR 11, Group 1, Class B
ESD Electrostatic discharge immunity test	Contact: ±8kV	IEC61000-4-2:2008 EN61000-4-2:2009
Radiated, radio-frequency, electromagnetic field immunity test	10V/m (80-1000MHz, 1.0-2.7GHz) 27V/m (385MHz) 28V/m (450, 810, 870, 930, 1720, 1845, 1970, 2450MHz) 9V/m (710, 745, 780, 5240, 5500, 5785MHz)	IEC61000-4-3:2006+A2:2010 EN61000-4-3:2006+A2:2010
Fast Transient and Burst Immunity	AC Power Port: ±2kV	IEC/EN61000-4-4:2012
Surge Immunity	AC Power Port: L-N ±1kV L-PE, N-PE: ±2kV	IEC/EN61000-4-5:2014
Immunity to conducted disturbances, induced by radio-frequency fields	3Vrms (0.15-80MHz) 6Vrms (ISM, amateur radio bands)	IEC61000-4-6:2013 EN61000-4-6:2014
Power Magnetic Field Immunity	30A/m, 50 Hz	IEC61000-4-8:2009 EN61000-4-8:2010
Voltage Dips and Interruptions	Voltage Dip 100% (0.5P) Voltage Dip 100% (1.0P) Voltage Dip 30% Voltage Interruption 100%	IEC/EN61000-4-11:2004
Limits of Harmonic Current Emissions	Class A	EN61000-3-2
Limits of Voltage Fluctuations & Flicker	Clause 5	EN61000-3-3

EMC Compliance (Industrial)		
Electromagnetic compatibility of multimedia equipment - Emission requirements ⁽⁹⁾		EN55032:2015, Class B
Electromagnetic compatibility of multimedia equipment - Immunity requirements		EN55035:2017
Information technology equipment - Immunity characteristics - Limits and methods of measurement		EN55024:2010 + A1:2015
Limitations on the amount of electromagnetic interference allowed from digital and electronic devices		FCC 47 CFR Part 15 Subpart B, ANSI C63.4:2014, Class B

Notes:

- Note11: The emission performance was tested with snap-on ferrite Wurth 742 712 21. The 48V versions with 2-turns of AC-line cable; the 24V version with 2-turns of N (neutral) line only. The output cables were used twisted pair lines, with the typical configuration of grounded return lines.
- Note12: Performance criteria A indicates operation within ±10% tolerance band of nominal settings

DIMENSION AND PHYSICAL CHARACTERISTICS		
Parameter	Type	Value
Material	case/baseplate PCB	aluminum FR4 (UL94 V-0)
Dimension (LxWxH)		228.0 x 96.2 x 40.0mm
Weight		1000g. typ.

continued on next page

Specifications (measured @ Ta= 25°C, nom. Vin, full load and after warm-up unless otherwise stated)

Dimension Drawing (mm)

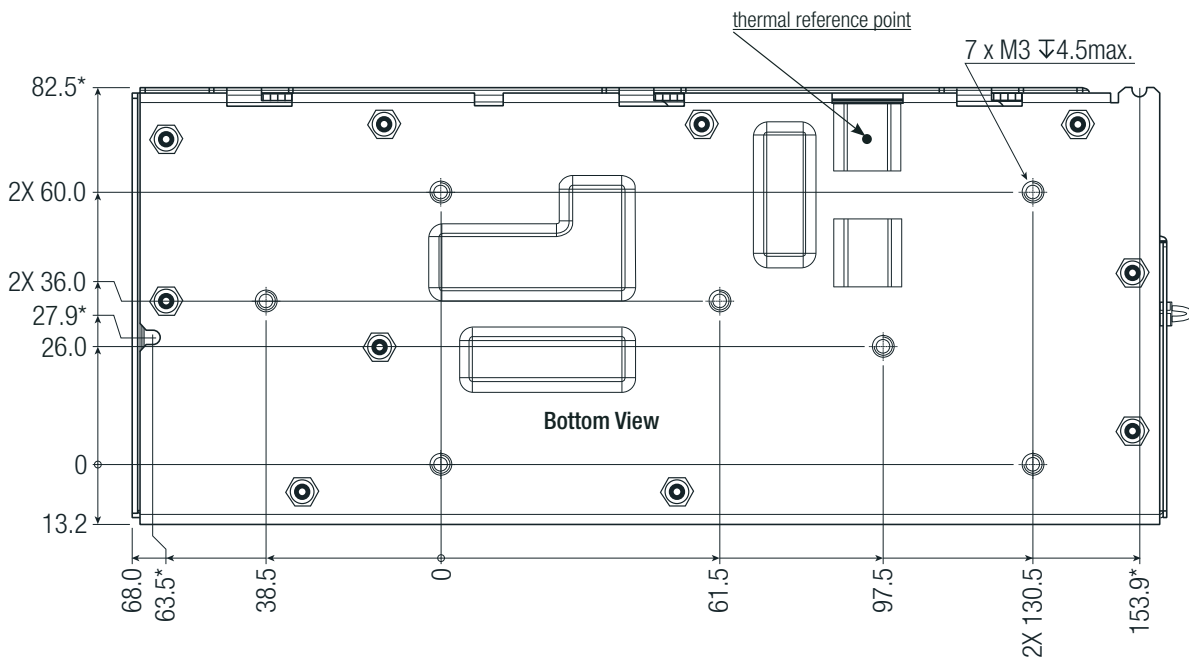
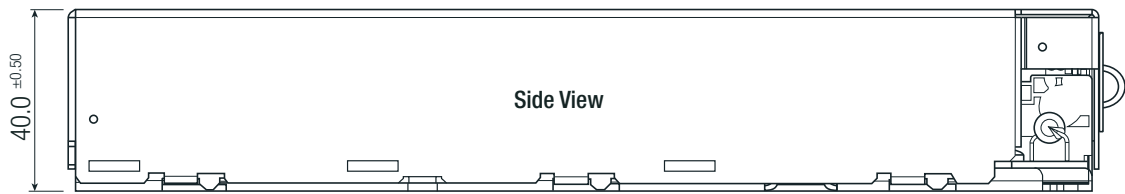
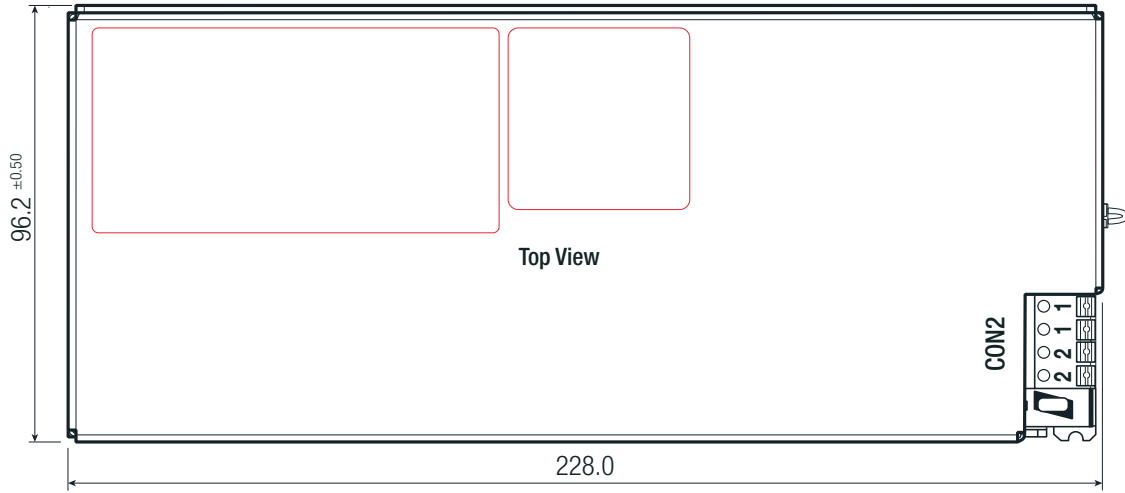

General tolerances according to ISO 2768-m (table for reference only)	
Dimension range	Tolerances
0.5 - 6 mm	±0.1 mm
6 - 30 mm	±0.2 mm
30 - 120 mm	±0.3 mm
120 - 400 mm	±0.5 mm

continued on next page

Specifications (measured @ Ta= 25°C, nom. Vin, full load and after warm-up unless otherwise stated)

Dimension Drawing (mm)

Front View (Input)

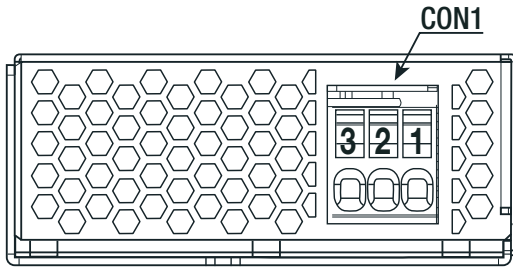

Back View (Output/Signal)

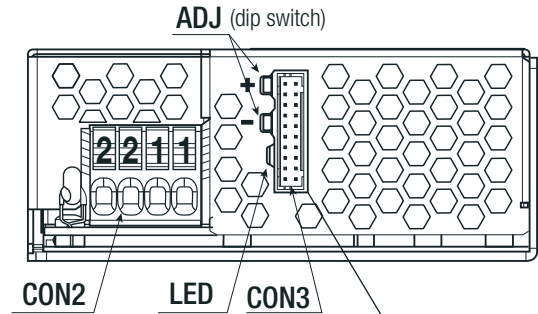

Connector information

AC Input CON1

#	Function	Terminal
1	AC/L	Phoenix
3	AC/N	TDPT 4-SP-6.35

DC Output Connector CON2

#	Function	Terminal
1,1	+Vout	Phoenix
2,2	-Vout	TDPT 2.5-SP-5.w08

General tolerances according to ISO 2768-m (table for reference only)

Dimension range	Tolerances
0.5 - 6 mm	±0.1 mm
6 - 30 mm	±0.2 mm
30 - 120 mm	±0.3 mm
120 - 400 mm	±0.5 mm

Connector information CON3

Cvilinear CI0120P1HD0.NH Type Pin Header

#	Function	#	Function
2	Reserved for factory config.	1	reserved for factory config.
4	Reserved for factory config.	3	NC
6	FAN ADJ	5	FAN+
8	NC	7	FAN RTN *
10	Remote Sense+	9	Remote Sense RTN
12	NC	11	NC
14	PSU_GOOD	13	AC_OK
16	Signal RTN *	15	Remote Sense Activation
18	Signal RTN	17	Remote ON/OFF
20	5VSB RTN	19	5VSB+

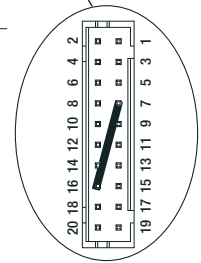

*Factory bridge from Pin7 (FAN RTN) to Pin16 (Signal RTN)

Mating connector CON3

Housing= Cvilinear CI0120SD000
Contact= Cvilinear CI01TD21PE0

Connection wire cross sections: during building in the product, installer needs to take care to use wires with appropriate cross-section for the rated voltage/currents

INSTALLATION AND APPLICATION

Mounting suggestions

horizontal

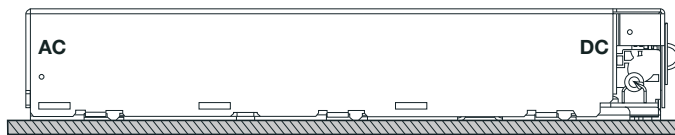

side

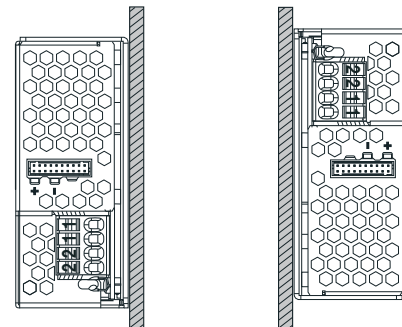

upside down

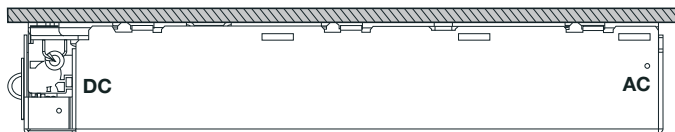

If the PSU is horizontal, upside down or side mounted, no derating is required.

With forced air cooling, mounting orientation has no impact on output power. Device should be fan cooled from AC side.

If thermal conduction cooling is suggested, use of heat sink compound is recommended for improved heat transfer via baseplate.

Specifications (measured @ Ta= 25°C, nom. Vin, full load and after warm-up unless otherwise stated)

PACKAGING INFORMATION

Parameter	Type	Value
Packaging Dimension (LxWxH)	cardboard box	303.0 x164.0 x 45.0mm
Packaging Quantity		1pcs
Storage Temperature Range		-40°C to +85°C
Storage Humidity	non-condensing	90% RH max.

The product information and specifications may be subject to changes even without prior written notice. The product has been designed for various applications; its suitability lies in the responsibility of each customer. The products are not authorized for use in safety-critical applications without RECOM's explicit written consent. A safety-critical application is an application where a failure may reasonably be expected to endanger or cause loss of life, inflict bodily harm or damage property. The applicant shall indemnify and hold harmless RECOM, its affiliated companies and its representatives against any damage claims in connection with the unauthorized use of RECOM products in such safety-critical applications.