



Is Now Part of



**ON Semiconductor®**

To learn more about ON Semiconductor, please visit our website at  
[www.onsemi.com](http://www.onsemi.com)

Please note: As part of the Fairchild Semiconductor integration, some of the Fairchild orderable part numbers will need to change in order to meet ON Semiconductor's system requirements. Since the ON Semiconductor product management systems do not have the ability to manage part nomenclature that utilizes an underscore (\_), the underscore (\_) in the Fairchild part numbers will be changed to a dash (-). This document may contain device numbers with an underscore (\_). Please check the ON Semiconductor website to verify the updated device numbers. The most current and up-to-date ordering information can be found at [www.onsemi.com](http://www.onsemi.com). Please email any questions regarding the system integration to [Fairchild\\_questions@onsemi.com](mailto:Fairchild_questions@onsemi.com).

ON Semiconductor and the ON Semiconductor logo are trademarks of Semiconductor Components Industries, LLC dba ON Semiconductor or its subsidiaries in the United States and/or other countries. ON Semiconductor owns the rights to a number of patents, trademarks, copyrights, trade secrets, and other intellectual property. A listing of ON Semiconductor's product/patent coverage may be accessed at [www.onsemi.com/site/pdf/Patent-Marking.pdf](http://www.onsemi.com/site/pdf/Patent-Marking.pdf). ON Semiconductor reserves the right to make changes without further notice to any products herein. ON Semiconductor makes no warranty, representation or guarantee regarding the suitability of its products for any particular purpose, nor does ON Semiconductor assume any liability arising out of the application or use of any product or circuit, and specifically disclaims any and all liability, including without limitation special, consequential or incidental damages. Buyer is responsible for its products and applications using ON Semiconductor products, including compliance with all laws, regulations and safety requirements or standards, regardless of any support or applications information provided by ON Semiconductor. "Typical" parameters which may be provided in ON Semiconductor data sheets and/or specifications can and do vary in different applications and actual performance may vary over time. All operating parameters, including "Typicals" must be validated for each customer application by customer's technical experts. ON Semiconductor does not convey any license under its patent rights nor the rights of others. ON Semiconductor products are not designed, intended, or authorized for use as a critical component in life support systems or any FDA Class 3 medical devices or medical devices with a same or similar classification in a foreign jurisdiction or any devices intended for implantation in the human body. Should Buyer purchase or use ON Semiconductor products for any such unintended or unauthorized application, Buyer shall indemnify and hold ON Semiconductor and its officers, employees, subsidiaries, affiliates, and distributors harmless against all claims, costs, damages, and expenses, and reasonable attorney fees arising out of, directly or indirectly, any claim of personal injury or death associated with such unintended or unauthorized use, even if such claim alleges that ON Semiconductor was negligent regarding the design or manufacture of the part. ON Semiconductor is an Equal Opportunity/Affirmative Action Employer. This literature is subject to all applicable copyright laws and is not for resale in any manner.

# FGP10N60UNDF

## 600 V, 10 A Short Circuit Rated IGBT

### Features

- Short Circuit Rated 10 us
- High Current Capability
- High Input Impedance
- Fast Switching
- RoHS Compliant

### General Description

Using advanced NPT IGBT technology, Fairchild's the NPT IGBTs offer the optimum performance for low-power inverter-driven applications where low-losses and short-circuit ruggedness features are essential, such as sewing machine, CNC, motor control and home appliances.

### Applications

- Sewing Machine, CNC, Home Appliances, Motor Control

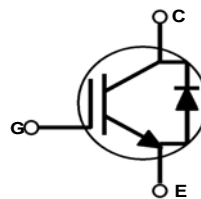
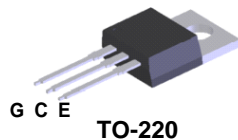

### Absolute Maximum Ratings

| Symbol      | Description   | Ratings     | Unit             |
|-------------|---|-------------|------------------|
| $V_{CES}$   | Collector to Emitter Voltage                          | 600         | V                |
| $V_{GES}$   | Gate to Emitter Voltage                               | $\pm 20$    | V                |
| $I_C$       | Collector Current @ $T_C = 25^\circ\text{C}$          | 20          | A                |
|             | Collector Current @ $T_C = 100^\circ\text{C}$         | 10          | A                |
| $I_{CM(1)}$ | Pulsed Collector Current @ $T_C = 25^\circ\text{C}$   | 30          | A                |
| $I_F$       | Diode Forward Current @ $T_C = 25^\circ\text{C}$      | 10          | A                |
|             | Diode Forward Current @ $T_C = 100^\circ\text{C}$     | 5           | A                |
| PD          | Maximum Power Dissipation @ $T_C = 25^\circ\text{C}$  | 139         | W                |
|             | Maximum Power Dissipation @ $T_C = 100^\circ\text{C}$ | 56          | W                |
| $T_J$       | Operating Junction Temperature                        | -55 to +150 | $^\circ\text{C}$ |
| $T_{stg}$   | Storage Temperature Range                             | -55 to +150 | $^\circ\text{C}$ |

**Notes:**

1: Repetitive rating: Pulse width limited by max. junction temperature

### Thermal Characteristics

| Symbol                        | Parameter  | Typ. | Max. | Unit                      |
|-------------------------------|--|------|------|---------------------------|
| $R_{\theta JC}(\text{IGBT})$  | Thermal Resistance, Junction to Case                   | -    | 0.9  | $^\circ\text{C}/\text{W}$ |
| $R_{\theta JC}(\text{Diode})$ | Thermal Resistance, Junction to Case                   | -    | 3.5  | $^\circ\text{C}/\text{W}$ |
| $R_{\theta JA}$               | Thermal Resistance, Junction to Ambient (PCB Mount)(2) | -    | 62.5 | $^\circ\text{C}/\text{W}$ |

**Notes:**

2: Mounted on 1" square PCB (FR4 or G-10 material)

### Package Marking and Ordering Information

| Device Marking | Device       | Package | Reel Size | Tape Width | Quantity |
|----------------|--------------|---------|-----------|------------|----------|
| FGP10N60UNDF   | FGP10N60UNDF | TO-220  | -         | -          | 50ea     |

### Electrical Characteristics of the IGBT T<sub>C</sub> = 25°C unless otherwise noted

| Symbol                           | Parameter                               | Test Conditions   | Min. | Typ. | Max. | Unit |
|----------------------------------|---|---|------|------|------|------|
| <b>Off Characteristics</b>       |   |   |      |      |      |      |
| BV <sub>CES</sub>                | Collector to Emitter Breakdown Voltage  | V <sub>GE</sub> = 0 V, I <sub>C</sub> = 250 μA  | 600  | -    | -    | V    |
| I <sub>CES</sub>                 | Collector Cut-Off Current               | V <sub>CE</sub> = V <sub>CES</sub> , V <sub>GE</sub> = 0 V  | -    | -    | 1    | mA   |
| I <sub>GES</sub>                 | G-E Leakage Current                     | V <sub>GE</sub> = V <sub>GES</sub> , V <sub>CE</sub> = 0 V  | -    | -    | ±10  | μA   |
| <b>On Characteristics</b>        |   |   |      |      |      |      |
| V <sub>GE(th)</sub>              | G-E Threshold Voltage                   | I <sub>C</sub> = 10 mA, V <sub>CE</sub> = V <sub>GE</sub>   | 5.5  | 6.8  | 8.5  | V    |
| V <sub>CE(sat)</sub>             | Collector to Emitter Saturation Voltage | I <sub>C</sub> = 10 A, V <sub>GE</sub> = 15 V   | -    | 2    | 2.45 | V    |
|                                  |   | I <sub>C</sub> = 10 A, V <sub>GE</sub> = 15 V, T <sub>C</sub> = 125°C   | -    | 2.3  | -    | V    |
| <b>Dynamic Characteristics</b>   |   |   |      |      |      |      |
| C <sub>ies</sub>                 | Input Capacitance                       | V <sub>CE</sub> = 30 V, V <sub>GE</sub> = 0 V, f = 1 MHz  | -    | 517  |      | pF   |
| C <sub>oes</sub>                 | Output Capacitance                      |   | -    | 65   |      | pF   |
| C <sub>res</sub>                 | Reverse Transfer Capacitance            |   | -    | 20   |      | pF   |
| <b>Switching Characteristics</b> |   |   |      |      |      |      |
| t <sub>d(on)</sub>               | Turn-On Delay Time                      | V <sub>CC</sub> = 400 V, I <sub>C</sub> = 10 A, R <sub>G</sub> = 10 Ω, V <sub>GE</sub> = 15 V, Inductive Load, T <sub>C</sub> = 25°C  | -    | 8.0  |      | ns   |
| t <sub>r</sub>                   | Rise Time                               |   | -    | 6.3  |      | ns   |
| t <sub>d(off)</sub>              | Turn-Off Delay Time                     |   | -    | 52.2 |      | ns   |
| t <sub>f</sub>                   | Fall Time                               |   | -    | 19.1 | 24.8 | ns   |
| E <sub>on</sub>                  | Turn-On Switching Loss                  |   | -    | 0.15 |      | mJ   |
| E <sub>off</sub>                 | Turn-Off Switching Loss                 |   | -    | 0.05 |      | mJ   |
| E <sub>ts</sub>                  | Total Switching Loss                    |   | -    | 0.2  |      | mJ   |
| t <sub>d(on)</sub>               | Turn-On Delay Time                      | V <sub>CC</sub> = 400 V, I <sub>C</sub> = 10 A, R <sub>G</sub> = 10 Ω, V <sub>GE</sub> = 15 V, Inductive Load, T <sub>C</sub> = 125°C | -    | 8.1  |      | ns   |
| t <sub>r</sub>                   | Rise Time                               |   | -    | 7.3  |      | ns   |
| t <sub>d(off)</sub>              | Turn-Off Delay Time                     |   | -    | 55.1 |      | ns   |
| t <sub>f</sub>                   | Fall Time                               |   | -    | 34.2 |      | ns   |
| E <sub>on</sub>                  | Turn-On Switching Loss                  |   | -    | 0.22 |      | mJ   |
| E <sub>off</sub>                 | Turn-Off Switching Loss                 |   | -    | 0.08 |      | mJ   |
| E <sub>ts</sub>                  | Total Switching Loss                    |   | -    | 0.3  |      | mJ   |
| T <sub>sc</sub>                  | Short Circuit Withstand Time            | V <sub>CC</sub> = 350 V, R <sub>G</sub> = 100 Ω, V <sub>GE</sub> = 15 V, T <sub>C</sub> = 150°C                                       | 10   | -    | -    | μs   |

**Electrical Characteristics of the IGBT**  $T_C = 25^\circ\text{C}$  unless otherwise noted

| Symbol   | Parameter                | Test Conditions  | Min. | Typ. | Max | Unit |
|----------|--------------------------|--|------|------|-----|------|
| $Q_g$    | Total Gate Charge        | $V_{CE} = 400\text{ V}, I_C = 10\text{ A},$<br>$V_{GE} = 1\text{ V}$ | -    | 37   |     | nC   |
| $Q_{ge}$ | Gate to Emitter Charge   |  | -    | 5    |     | nC   |
| $Q_{gc}$ | Gate to Collector Charge |  | -    | 21   |     | nC   |

**Electrical Characteristics of the Diode**  $T_C = 25^\circ\text{C}$  unless otherwise noted

| Symbol   | Parameter                     | Test Conditions   | Min.                      | Typ. | Max  | Unit |    |
|----------|-------------------------------|---|---------------------------|------|------|------|----|
| $V_{FM}$ | Diode Forward Voltage         | $I_F = 10\text{ A}$                                     | $T_C = 25^\circ\text{C}$  | -    | 1.8  | 2.2  | V  |
|          |                               |   | $T_C = 125^\circ\text{C}$ | -    | 1.7  |      |    |
| $t_{rr}$ | Diode Reverse Recovery Time   | $I_F = 10\text{ A}, dI_F/dt = 200\text{ A}/\mu\text{s}$ | $T_C = 25^\circ\text{C}$  | -    | 37.7 |      | ns |
|          |                               |   | $T_C = 125^\circ\text{C}$ | -    | 78.9 |      |    |
| $Q_{rr}$ | Diode Reverse Recovery Charge | $I_F = 10\text{ A}, dI_F/dt = 200\text{ A}/\mu\text{s}$ | $T_C = 25^\circ\text{C}$  | -    | 75   |      | nC |
|          |                               |   | $T_C = 125^\circ\text{C}$ | -    | 221  |      |    |



## Typical Performance Characteristics

Figure 1. Typical Output Characteristics

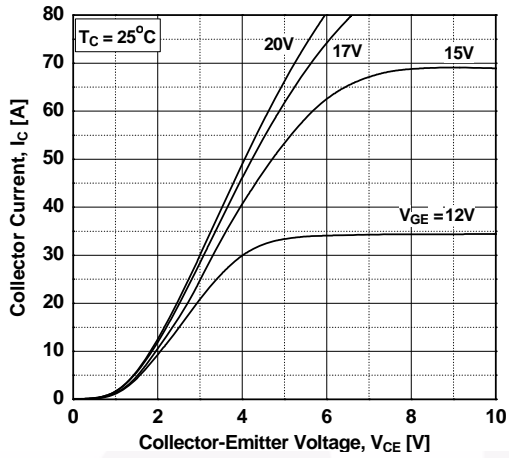

Figure 2. Typical Output Characteristics

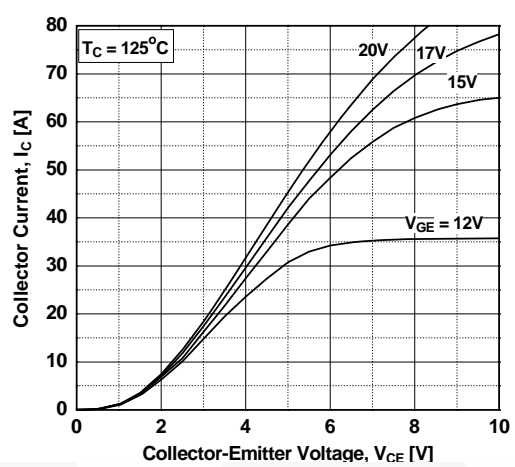

Figure 3. Typical Saturation Voltage Characteristics

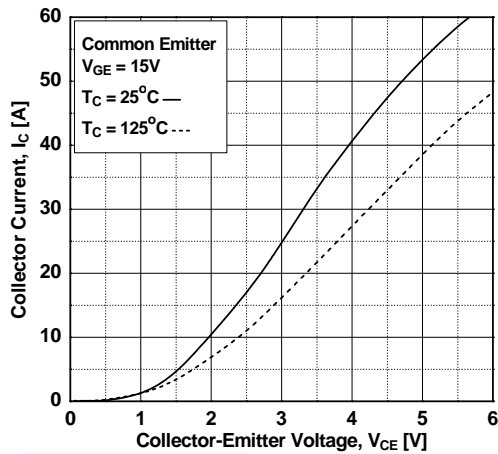

Figure 4. Transfer Characteristics

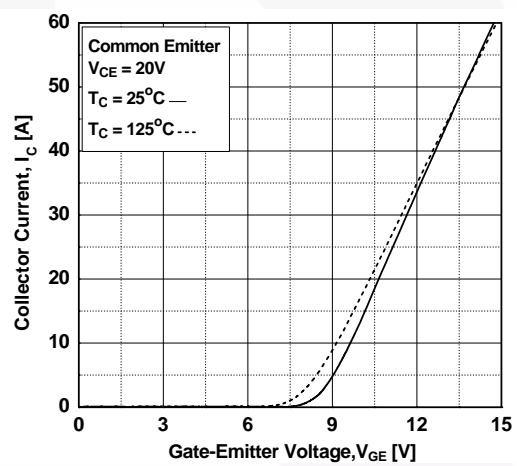

Figure 5. Saturation Voltage vs. Case Temperature at Variant Current Level

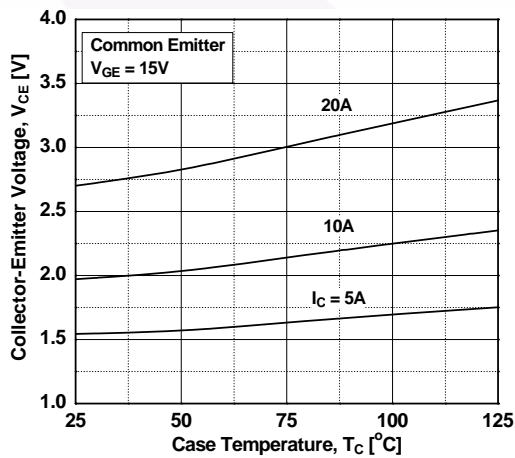
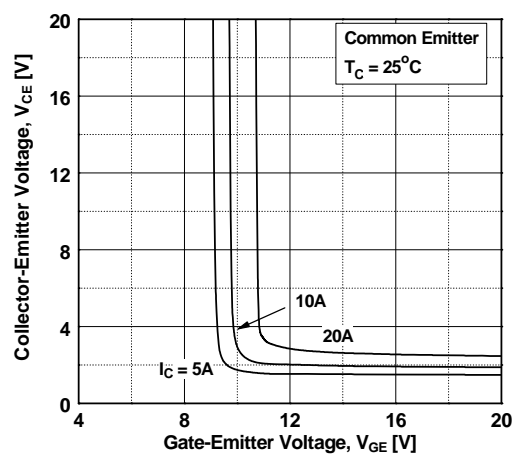

Figure 6. Saturation Voltage vs. Vge



## Typical Performance Characteristics

Figure 7. Saturation Voltage vs.  $V_{GE}$

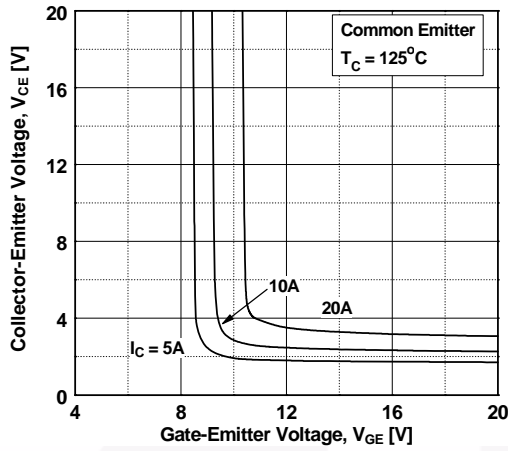

Figure 8. Capacitance Characteristics

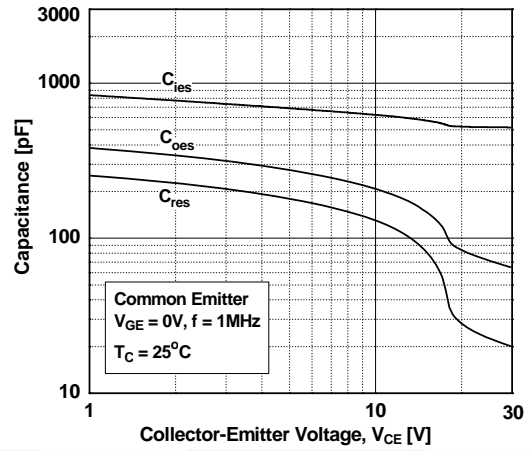

Figure 9. Gate charge Characteristics

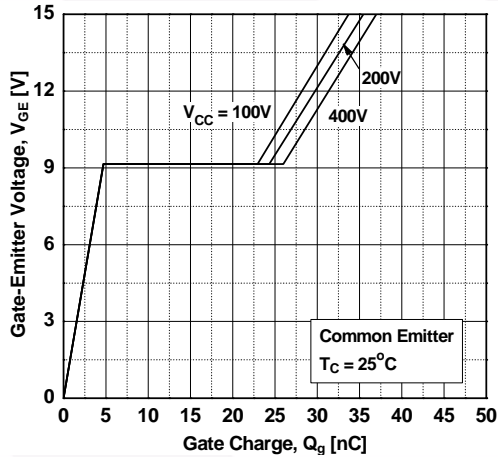

Figure 10. SOA Characteristics

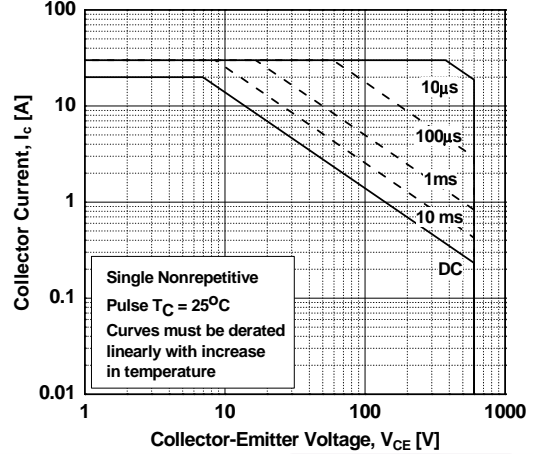

Figure 11. Turn-on Characteristics vs. Gate Resistance

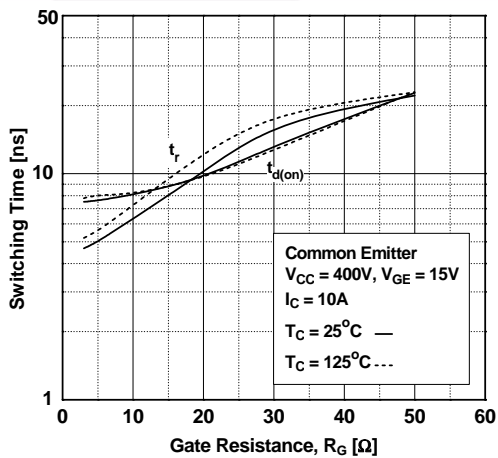
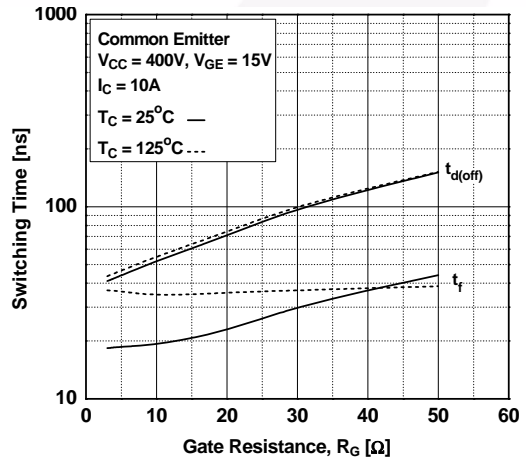
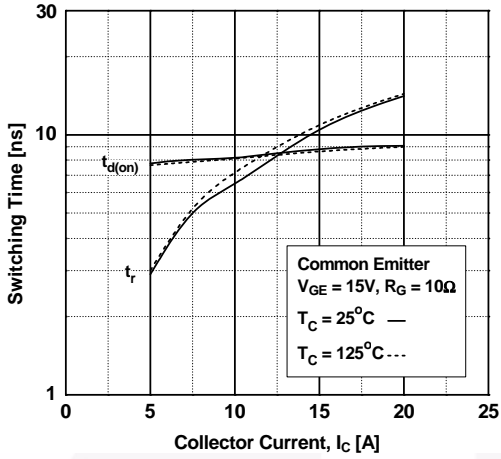

Figure 12. Turn-off Characteristics vs. Gate Resistance



### Typical Performance Characteristics

**Figure 13. Turn-on Characteristics vs. Collector Current**



**Figure 14. Turn-off Characteristics vs. Collector Current**

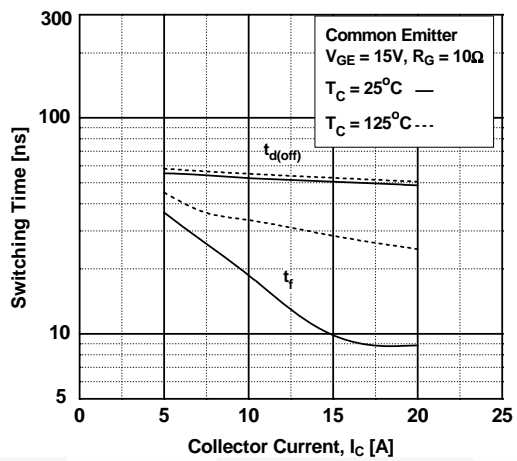

**Figure 15. Switching Loss vs. Gate Resistance**

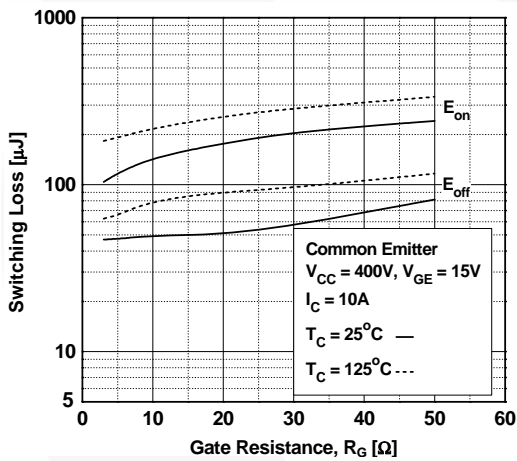

**Figure 16. Switching Loss vs. Collector Current**

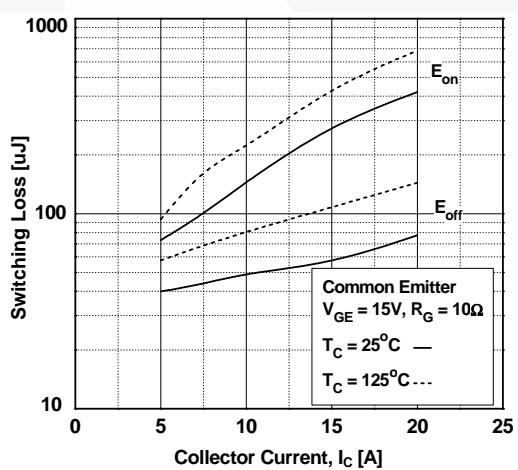

**Figure 17. Turn off Switching SOA Characteristics**

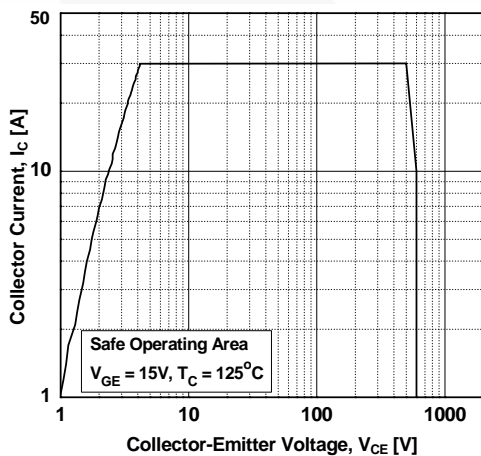

**Figure 18. Forward Characteristics**

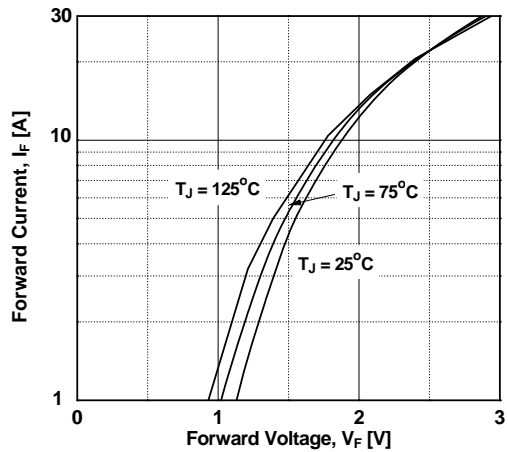

## Typical Performance Characteristics

Figure 19. Reverse Recovery Current

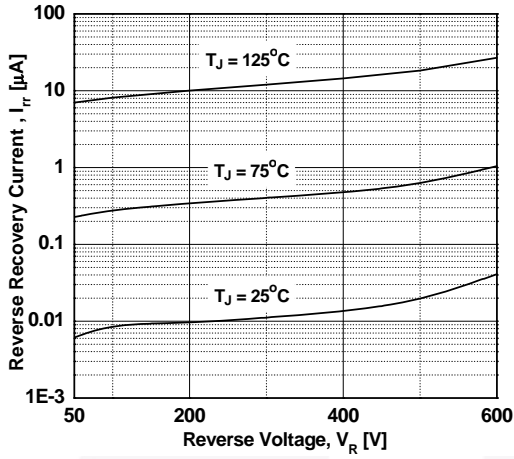

Figure 20. Stored Charge

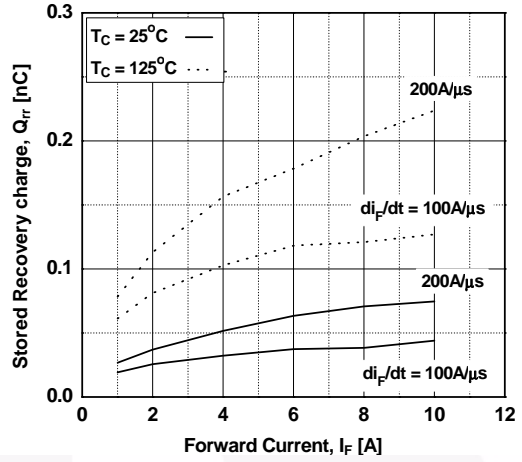

Figure 21. Reverse Recovery Time

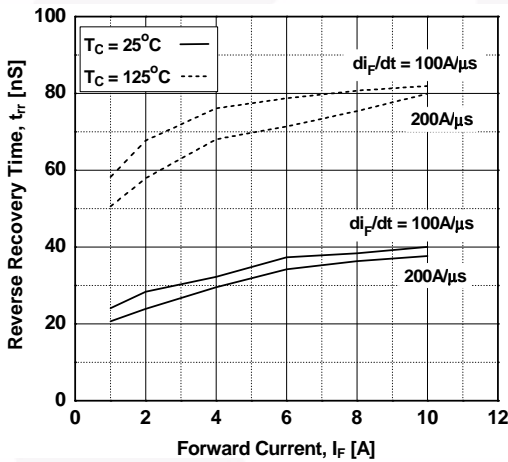
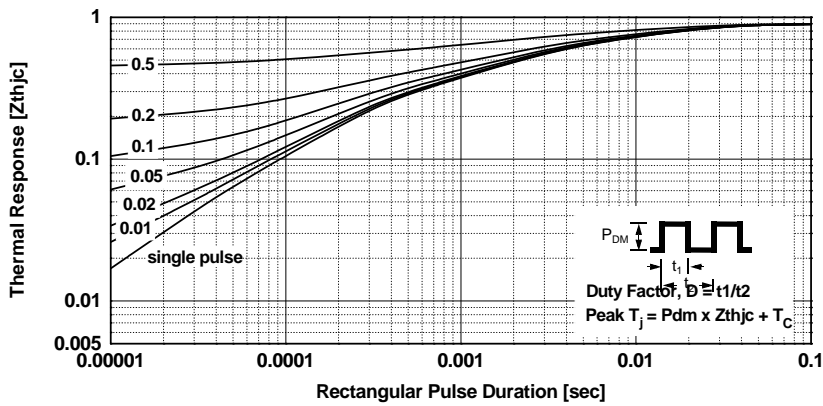
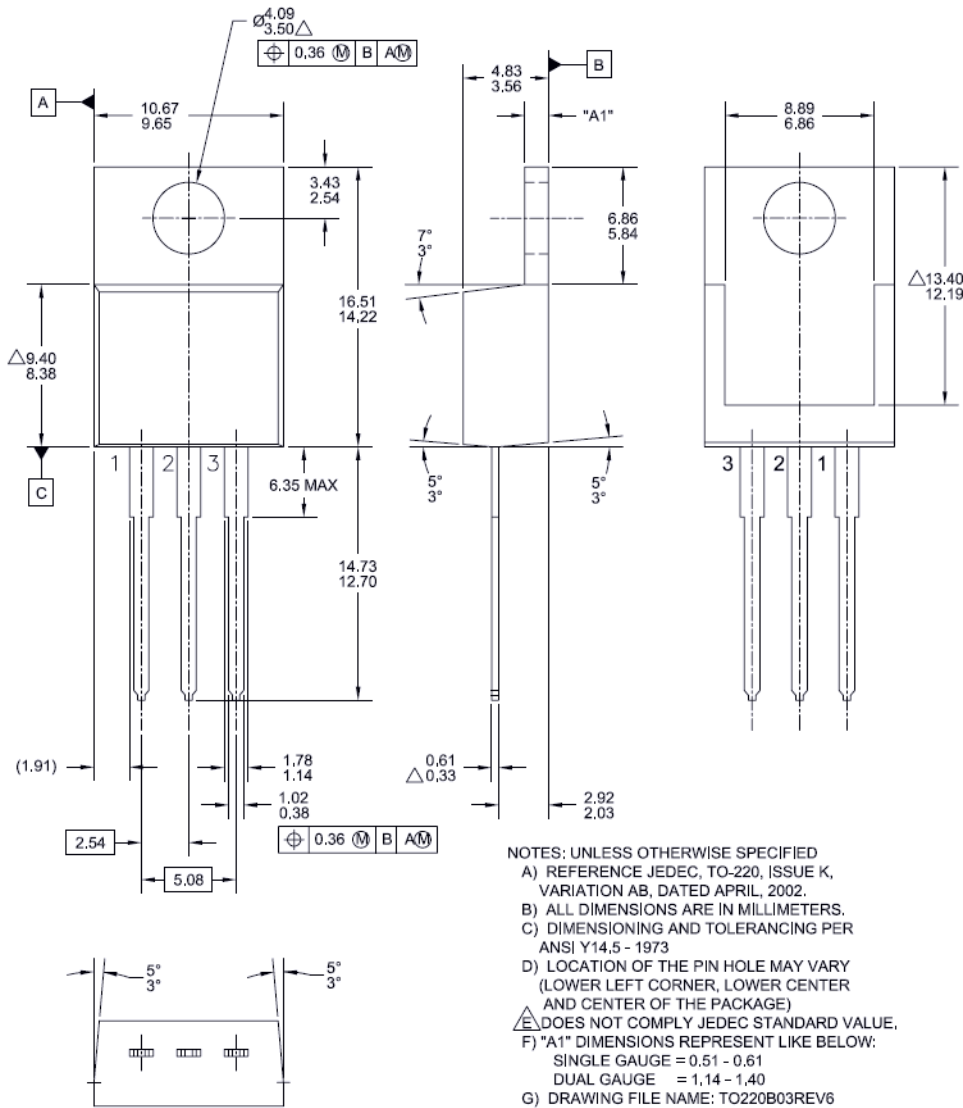

Figure 22. Transient Thermal Impedance of IGBT



## Mechanical Dimensions



**Figure 23. TO-220 3L - TO-220, MOLDED, 3LEAD, JEDEC VARIATION AB**

Package drawings are provided as a service to customers considering Fairchild components. Drawings may change in any manner without notice. Please note the revision and/or date on the drawing and contact a Fairchild Semiconductor representative to verify or obtain the most recent revision. Package specifications do not expand the terms of Fairchild's worldwide terms and conditions, specifically the warranty therein, which covers Fairchild products.

Always visit Fairchild Semiconductor's online packaging area for the most recent package drawings:





[http://www.fairchildsemi.com/package/packageDetails.html?id=PN\\_TT220-003](http://www.fairchildsemi.com/package/packageDetails.html?id=PN_TT220-003)

Dimensions in Millimeters



**TRADEMARKS**

The following includes registered and unregistered trademarks and service marks, owned by Fairchild Semiconductor and/or its global subsidiaries, and is not intended to be an exhaustive list of all such trademarks.

- |  |   |   |  |
|--|---|---|--|
| AccuPower™   | F-PFST™   | PowerTrench®  | Sync-Lock™   |
| AX-CAP®*   | FRFET®  | PowerXS™  |  SYSTEM®* |
| BitSiC™  | Global Power Resource <sup>SM</sup>             | Programmable Active Droop™  | TinyBoost®   |
| Build it Now™  | GreenBridge™                                    | QFET®   | TinyBuck™  |
| CorePLUS™  | Green FPS™                                      | QS™   | TinyCalc™  |
| CorePOWER™   | Green FPS™ e-Series™                            | Quiet Series™   | TinyLogic®   |
| CROSSVOLT™   | Gmax™   | RapidConfigure™   | TINYOPTO™  |
| CTL™   | GTO™  |   | TinyPower™   |
| Current Transfer Logic™  | IntelliMAX™                                     |  Saving our world, 1mW/W/kW at a time™ | TinyPWM™   |
| DEUXPEED®  | ISOPLANAR™                                      | SignalWise™   | TinyWire™  |
| Dual Cool™   | Marking Small Speakers Sound Louder and Better™ | SmartMax™   | TranSiC™   |
| EcoSPARK®  | MegaBuck™                                       | SMART START™  | TriFault Detect™   |
| EfficientMax™  | MICROCOUPLER™                                   | Solutions for Your Success™   | TRUECURRENT®*  |
| ESBC™  | MicroFET™                                       | SPM®  | µSerDes™   |
|  Fairchild® | MicroPak™                                       | STEALTH™  |  SerDes®  |
| Fairchild Semiconductor®   | MicroPak2™                                      | SuperFET®   | UHC®   |
| FACT Quiet Series™   | MillerDrive™                                    | SuperSOT™-3   | Ultra FRFET™   |
| FACT®  | MotionMax™                                      | SuperSOT™-6   | UniFET™  |
| FAST®  | mWSaver®  | SuperSOT™-8   | VCX™   |
| FastvCore™   | OptoHiT™  | SupreMOS®   | VisualMax™   |
| FETBench™  | OPTOLOGIC®                                      | SyncFET™  | VoltagePlus™   |
| FPS™   | OPTOPLANAR®                                     |   | XS™  |

\*Trademarks of System General Corporation, used under license by Fairchild Semiconductor.

**DISCLAIMER**

FAIRCHILD SEMICONDUCTOR RESERVES THE RIGHT TO MAKE CHANGES WITHOUT FURTHER NOTICE TO ANY PRODUCTS HEREIN TO IMPROVE RELIABILITY, FUNCTION, OR DESIGN. FAIRCHILD DOES NOT ASSUME ANY LIABILITY ARISING OUT OF THE APPLICATION OR USE OF ANY PRODUCT OR CIRCUIT DESCRIBED HEREIN; NEITHER DOES IT CONVEY ANY LICENSE UNDER ITS PATENT RIGHTS, NOR THE RIGHTS OF OTHERS. THESE SPECIFICATIONS DO NOT EXPAND THE TERMS OF FAIRCHILD'S WORLDWIDE TERMS AND CONDITIONS, SPECIFICALLY THE WARRANTY THEREIN, WHICH COVERS THESE PRODUCTS.

**LIFE SUPPORT POLICY**

FAIRCHILD'S PRODUCTS ARE NOT AUTHORIZED FOR USE AS CRITICAL COMPONENTS IN LIFE SUPPORT DEVICES OR SYSTEMS WITHOUT THE EXPRESS WRITTEN APPROVAL OF FAIRCHILD SEMICONDUCTOR CORPORATION.

As used here in:

- Life support devices or systems are devices or systems which, (a) are intended for surgical implant into the body or (b) support or sustain life, and (c) whose failure to perform when properly used in accordance with instructions for use provided in the labeling, can be reasonably expected to result in a significant injury of the user.
- A critical component in any component of a life support, device, or system whose failure to perform can be reasonably expected to cause the failure of the life support device or system, or to affect its safety or effectiveness.

**ANTI-COUNTERFEITING POLICY**

Fairchild Semiconductor Corporation's Anti-Counterfeiting Policy. Fairchild's Anti-Counterfeiting Policy is also stated on our external website, www.Fairchildsemi.com, under Sales Support. Counterfeiting of semiconductor parts is a growing problem in the industry. All manufactures of semiconductor products are experiencing counterfeiting of their parts. Customers who inadvertently purchase counterfeit parts experience many problems such as loss of brand reputation, substandard performance, failed application, and increased cost of production and manufacturing delays. Fairchild is taking strong measures to protect ourselves and our customers from the proliferation of counterfeit parts. Fairchild strongly encourages customers to purchase Fairchild parts either directly from Fairchild or from Authorized Fairchild Distributors who are listed by country on our web page cited above. Products customers buy either from Fairchild directly or from Authorized Fairchild Distributors are genuine parts, have full traceability, meet Fairchild's quality standards for handling and storage and provide access to Fairchild's full range of up-to-date technical and product information. Fairchild and our Authorized Distributors will stand behind all warranties and will appropriately address and warranty issues that may arise. Fairchild will not provide any warranty coverage or other assistance for parts bought from Unauthorized Sources. Fairchild is committed to combat this global problem and encourage our customers to do their part in stopping this practice by buying direct or from authorized distributors.

**PRODUCT STATUS DEFINITIONS**

Definition of Terms

| Datasheet Identification | Product Status        | Definition  |
|--------------------------|-----------------------|---|
| Advance Information      | Formative / In Design | Datasheet contains the design specifications for product development. Specifications may change in any manner without notice.   |
| Preliminary              | First Production      | Datasheet contains preliminary data; supplementary data will be published at a later date. Fairchild Semiconductor reserves the right to make changes at any time without notice to improve design. |
| No Identification Needed | Full Production       | Datasheet contains final specifications. Fairchild Semiconductor reserves the right to make changes at any time without notice to improve the design.   |
| Obsolete                 | Not In Production     | Datasheet contains specifications on a product that is discontinued by Fairchild Semiconductor. The datasheet is for reference information only.  |

Rev. I66

ON Semiconductor and  are trademarks of Semiconductor Components Industries, LLC dba ON Semiconductor or its subsidiaries in the United States and/or other countries. ON Semiconductor owns the rights to a number of patents, trademarks, copyrights, trade secrets, and other intellectual property. A listing of ON Semiconductor's product/patent coverage may be accessed at [www.onsemi.com/site/pdf/Patent-Marking.pdf](http://www.onsemi.com/site/pdf/Patent-Marking.pdf). ON Semiconductor reserves the right to make changes without further notice to any products herein. ON Semiconductor makes no warranty, representation or guarantee regarding the suitability of its products for any particular purpose, nor does ON Semiconductor assume any liability arising out of the application or use of any product or circuit, and specifically disclaims any and all liability, including without limitation special, consequential or incidental damages. Buyer is responsible for its products and applications using ON Semiconductor products, including compliance with all laws, regulations and safety requirements or standards, regardless of any support or applications information provided by ON Semiconductor. "Typical" parameters which may be provided in ON Semiconductor data sheets and/or specifications can and do vary in different applications and actual performance may vary over time. All operating parameters, including "Typicals" must be validated for each customer application by customer's technical experts. ON Semiconductor does not convey any license under its patent rights nor the rights of others. ON Semiconductor products are not designed, intended, or authorized for use as a critical component in life support systems or any FDA Class 3 medical devices or medical devices with a same or similar classification in a foreign jurisdiction or any devices intended for implantation in the human body. Should Buyer purchase or use ON Semiconductor products for any such unintended or unauthorized application, Buyer shall indemnify and hold ON Semiconductor and its officers, employees, subsidiaries, affiliates, and distributors harmless against all claims, costs, damages, and expenses, and reasonable attorney fees arising out of, directly or indirectly, any claim of personal injury or death associated with such unintended or unauthorized use, even if such claim alleges that ON Semiconductor was negligent regarding the design or manufacture of the part. ON Semiconductor is an Equal Opportunity/Affirmative Action Employer. This literature is subject to all applicable copyright laws and is not for resale in any manner.

## PUBLICATION ORDERING INFORMATION

### LITERATURE FULFILLMENT:

Literature Distribution Center for ON Semiconductor  
19521 E. 32nd Pkwy, Aurora, Colorado 80011 USA  
**Phone:** 303-675-2175 or 800-344-3860 Toll Free USA/Canada  
**Fax:** 303-675-2176 or 800-344-3867 Toll Free USA/Canada  
**Email:** [orderlit@onsemi.com](mailto:orderlit@onsemi.com)

**N. American Technical Support:** 800-282-9855 Toll Free  
USA/Canada  
**Europe, Middle East and Africa Technical Support:**  
Phone: 421 33 790 2910  
**Japan Customer Focus Center**  
Phone: 81-3-5817-1050

**ON Semiconductor Website:** [www.onsemi.com](http://www.onsemi.com)  
**Order Literature:** <http://www.onsemi.com/orderlit>  
For additional information, please contact your local  
Sales Representative