

## Trench gate field-stop, 650 V, 20 A, high-speed HB2 series IGBT in a TO-247 long leads package

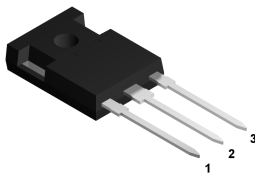

TO-247 long leads

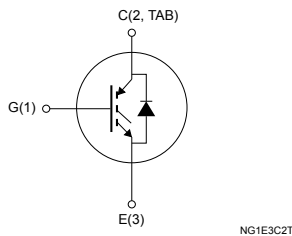

### Features

- Maximum junction temperature :  $T_J = 175\text{ }^\circ\text{C}$
- Low  $V_{CE(sat)} = 1.65\text{ V (typ.) @ } I_C = 20\text{ A}$
- Very fast and soft recovery co-packaged diode
- Minimized tail current
- Tight parameter distribution
- Low thermal resistance
- Positive  $V_{CE(sat)}$  temperature coefficient

### Applications

- Welding
- Power factor correction
- UPS
- Solar inverters
- Chargers

### Description

The newest IGBT 650 V HB2 series represents an evolution of the advanced proprietary trench gate field-stop structure. The performance of the HB2 series is optimized in terms of conduction, thanks to a better  $V_{CE(sat)}$  behavior at low current values, as well as in terms of reduced switching energy. A very fast soft recovery diode is co-packaged in antiparallel with the IGBT. The result is a product specifically designed to maximize efficiency for a wide range of fast applications.

#### Product status link

[STGWA20H65DFB2](#)

#### Product summary

<b>Order code</b>	STGWA20H65DFB2
<b>Marking</b>	G20H65DFB2
<b>Package</b>	TO-247 long leads
<b>Packing</b>	Tube

# 1 Electrical ratings

**Table 1. Absolute maximum ratings**

Symbol	Parameter	Value	Unit
$V_{CES}$	Collector-emitter voltage ( $V_{GE} = 0$ V)	650	V
$I_C$	Continuous collector current at $T_C = 25$ °C	40	A
	Continuous collector current at $T_C = 100$ °C	25	A
$I_{CP}^{(1)(2)}$	Pulsed collector current	60	A
$V_{GE}$	Gate-emitter voltage	$\pm 20$	V
	Transient gate-emitter voltage ( $t_p \leq 10$ $\mu$ s)	$\pm 30$	
$I_F$	Continuous forward current at $T_C = 25$ °C	40	A
	Continuous forward current at $T_C = 100$ °C	23	
$I_{FP}^{(1)(2)}$	Pulsed forward current	60	A
$P_{TOT}$	Total power dissipation at $T_C = 25$ °C	147	W
$T_{STG}$	Storage temperature range	-55 to 150	°C
$T_J$	Operating junction temperature range	-55 to 175	°C

1. Pulse width is limited by maximum junction temperature.
2. Defined by design, not subject to production test.

**Table 2. Thermal data**

Symbol	Parameter	Value	Unit
$R_{thJC}$	Thermal resistance junction-case IGBT	1.02	°C/W
	Thermal resistance junction-case diode	1.47	
$R_{thJA}$	Thermal resistance junction-ambient	50	

## 2 Electrical characteristics

$T_C = 25\text{ °C}$  unless otherwise specified

**Table 3. Static characteristics**

Symbol	Parameter	Test conditions	Min.	Typ.	Max.	Unit
$V_{(BR)CES}$	Collector-emitter breakdown voltage	$V_{GE} = 0\text{ V}$ , $I_C = 1\text{ mA}$	650			V
$V_{CE(sat)}$	Collector-emitter saturation voltage	$V_{GE} = 15\text{ V}$ , $I_C = 20\text{ A}$		1.65	2.1	V
		$V_{GE} = 15\text{ V}$ , $I_C = 20\text{ A}$ , $T_J = 125\text{ °C}$		1.95		
		$V_{GE} = 15\text{ V}$ , $I_C = 20\text{ A}$ , $T_J = 175\text{ °C}$		2.1		
$V_F$	Forward on-voltage	$I_F = 20\text{ A}$		1.65	2.55	V
		$I_F = 20\text{ A}$ , $T_J = 125\text{ °C}$		1.4		
		$I_F = 20\text{ A}$ , $T_J = 175\text{ °C}$		1.3		
$V_{GE(th)}$	Gate threshold voltage	$V_{CE} = V_{GE}$ , $I_C = 1\text{ mA}$	5	6	7	V
$I_{CES}$	Collector cut-off current	$V_{GE} = 0\text{ V}$ , $V_{CE} = 650\text{ V}$			25	$\mu\text{A}$
$I_{GES}$	Gate-emitter leakage current	$V_{CE} = 0\text{ V}$ , $V_{GE} = \pm 20\text{ V}$			$\pm 250$	nA

**Table 4. Dynamic characteristics**

Symbol	Parameter	Test conditions	Min.	Typ.	Max.	Unit
$C_{ies}$	Input capacitance	$V_{CE} = 25\text{ V}$ , $f = 1\text{ MHz}$ , $V_{GE} = 0\text{ V}$	-	1010	-	pF
$C_{oes}$	Output capacitance		-	81	-	
$C_{res}$	Reverse transfer capacitance		-	26	-	
$Q_g$	Total gate charge	$V_{CC} = 520\text{ V}$ , $I_C = 20\text{ A}$ , $V_{GE} = 0\text{ to }15\text{ V}$ (see Figure 28. Gate charge test circuit)	-	56	-	nC
$Q_{ge}$	Gate-emitter charge		-	9.4	-	
$Q_{gc}$	Gate-collector charge		-	27.8	-	

**Table 5. Switching characteristics (inductive load)**

Symbol	Parameter	Test conditions	Min.	Typ.	Max.	Unit
$t_{d(on)}$	Turn-on delay time	$V_{CC} = 400\text{ V}$ , $I_C = 20\text{ A}$ , $V_{GE} = 15\text{ V}$ , $R_G = 10\ \Omega$ (see Figure 27. Test circuit for inductive load switching)	-	16	-	ns
$t_r$	Current rise time		-	8	-	ns
$E_{on(1)}$	Turn-on switching energy		-	265	-	$\mu\text{J}$
$t_{d(off)}$	Turn-off delay time		-	78.8	-	ns
$t_f$	Current fall time		-	35	-	ns
$E_{off(2)}$	Turn-off switching energy		-	214	-	$\mu\text{J}$
$t_{d(on)}$	Turn-on delay time	$V_{CC} = 400\text{ V}$ , $I_C = 20\text{ A}$ , $V_{GE} = 15\text{ V}$ , $R_G = 10\ \Omega$ , $T_J = 175\text{ }^\circ\text{C}$ (see Figure 27. Test circuit for inductive load switching)	-	17	-	ns
$t_r$	Current rise time		-	9	-	ns
$E_{on(1)}$	Turn-on switching energy		-	556	-	$\mu\text{J}$
$t_{d(off)}$	Turn-off delay time		-	98	-	ns
$t_f$	Current fall time		-	80	-	ns
$E_{off(2)}$	Turn-off switching energy		-	378	-	$\mu\text{J}$

1. Including the reverse recovery of the diode.
2. Including the tail of the collector current.

**Table 6. Diode switching characteristics (inductive load)**

Symbol	Parameter	Test conditions	Min.	Typ.	Max.	Unit
$t_{rr}$	Reverse recovery time	$I_F = 20\text{ A}$ , $V_R = 400\text{ V}$ , $V_{GE} = 15\text{ V}$ , $di/dt = 1000\text{ A}/\mu\text{s}$ (see Figure 30. Diode reverse recovery waveform)	-	215	-	ns
$Q_{rr}$	Reverse recovery charge		-	970	-	nC
$I_{rrm}$	Reverse recovery current		-	17	-	A
$dI_{rr}/dt$	Peak rate of fall of reverse recovery current during $t_b$		-	303	-	$\text{A}/\mu\text{s}$
$E_{rr}$	Reverse recovery energy		-	293	-	$\mu\text{J}$
$t_{rr}$	Reverse recovery time	$I_F = 20\text{ A}$ , $V_R = 400\text{ V}$ , $V_{GE} = 15\text{ V}$ , $di/dt = 1000\text{ A}/\mu\text{s}$ , $T_J = 175\text{ }^\circ\text{C}$ (see Figure 30. Diode reverse recovery waveform)	-	330	-	ns
$Q_{rr}$	Reverse recovery charge		-	2772	-	nC
$I_{rrm}$	Reverse recovery current		-	30	-	A
$dI_{rr}/dt$	Peak rate of fall of reverse recovery current during $t_b$		-	244	-	$\text{A}/\mu\text{s}$
$E_{rr}$	Reverse recovery energy		-	866	-	$\mu\text{J}$

## 2.1 Electrical characteristics (curves)

**Figure 1. Power dissipation vs case temperature**

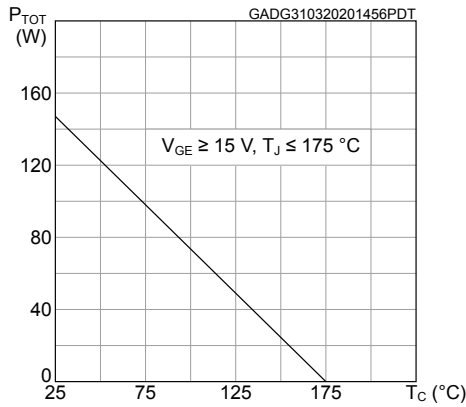

**Figure 2. Collector current vs case temperature**

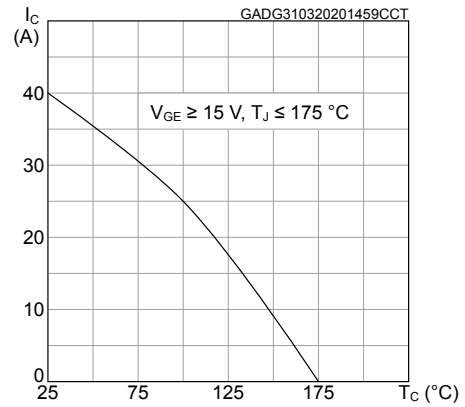

**Figure 3. Output characteristics (T<sub>J</sub> = 25 °C)**

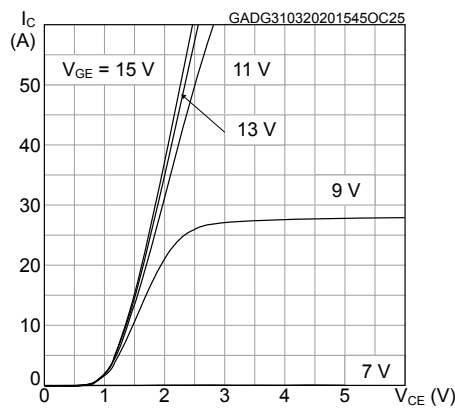

**Figure 4. Output characteristics (T<sub>J</sub> = 175 °C)**

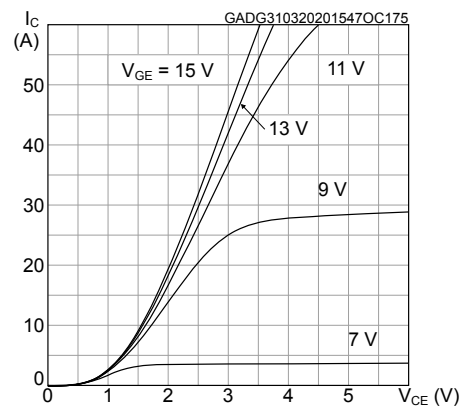

**Figure 5. V<sub>CE(sat)</sub> vs junction temperature**

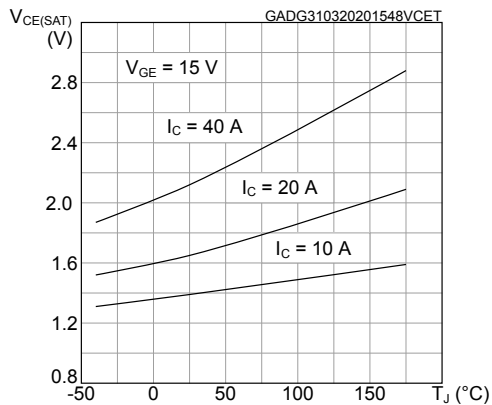

**Figure 6. V<sub>CE(sat)</sub> vs collector current**

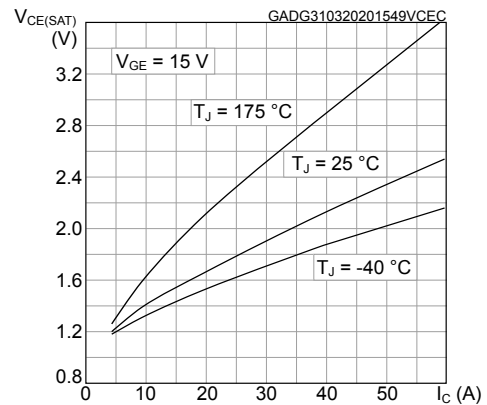

**Figure 7. Forward bias safe operating area**

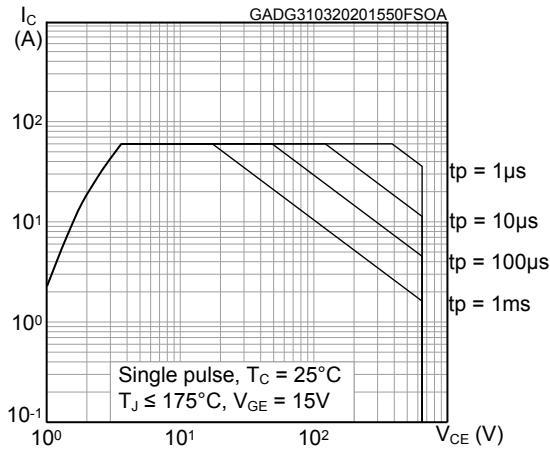

**Figure 8. Collector current vs switching frequency**

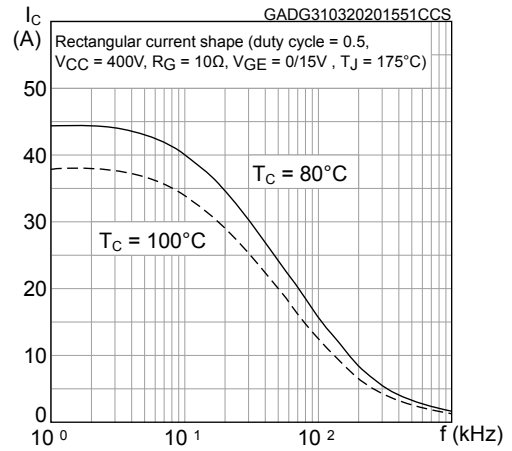

**Figure 9. Transfer characteristics**

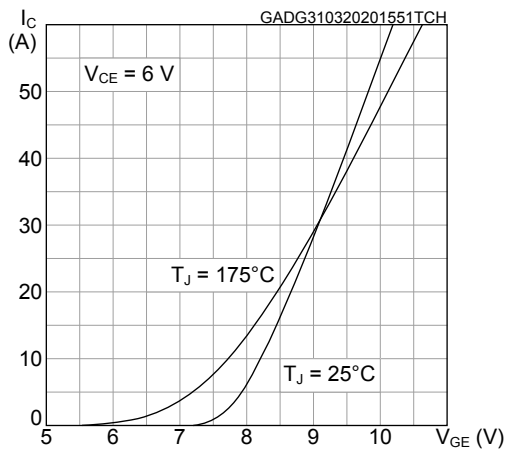

**Figure 10. Diode V\_F vs forward current**

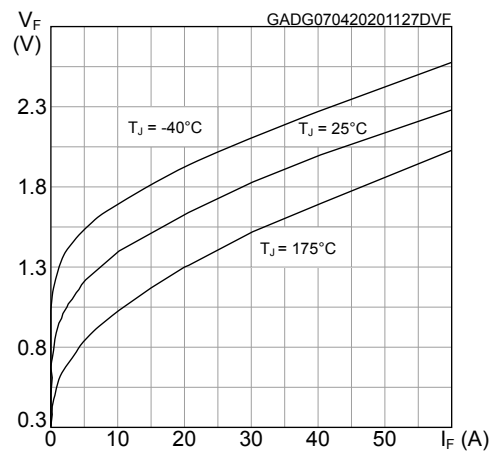

**Figure 11. Normalized V\_GE(th) vs junction temperature**

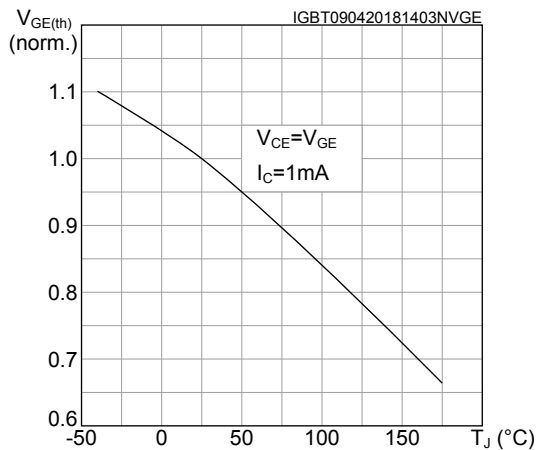

**Figure 12. Normalized V\_(BR)CES vs junction temperature**

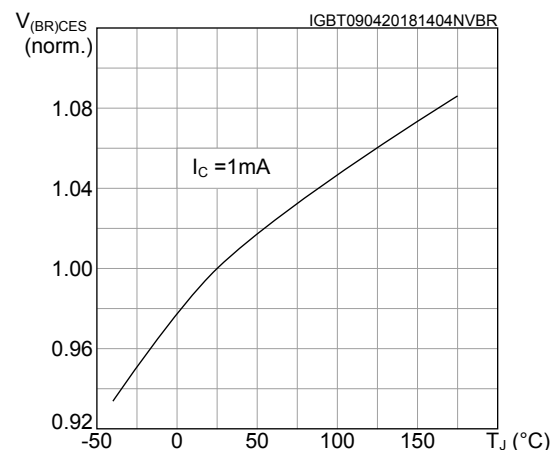

**Figure 13. Capacitance variations**

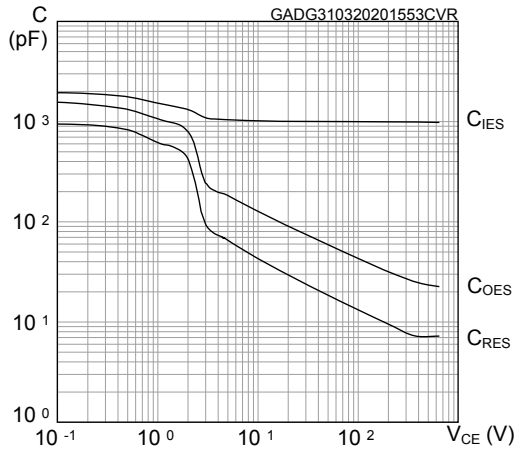

**Figure 14. Gate charge vs gate-emitter voltage**

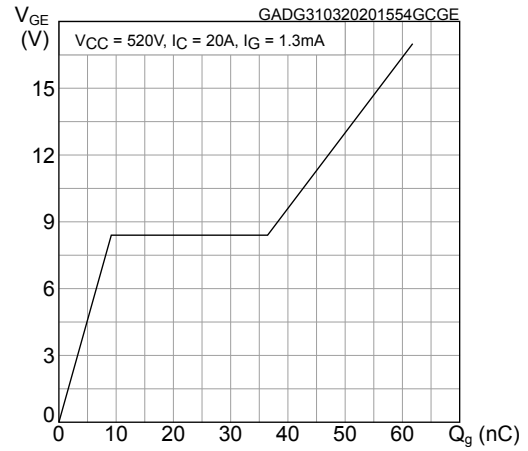

**Figure 15. Switching energy vs collector current**

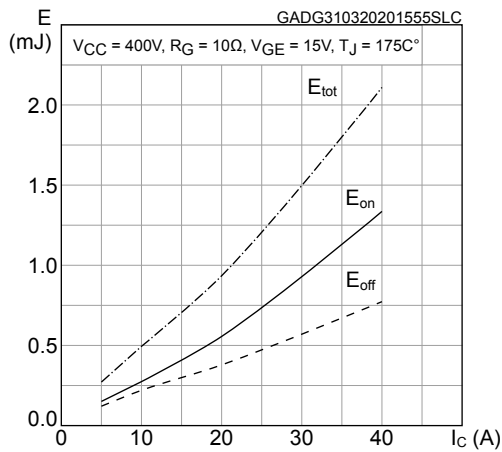

**Figure 16. Switching energy vs temperature**

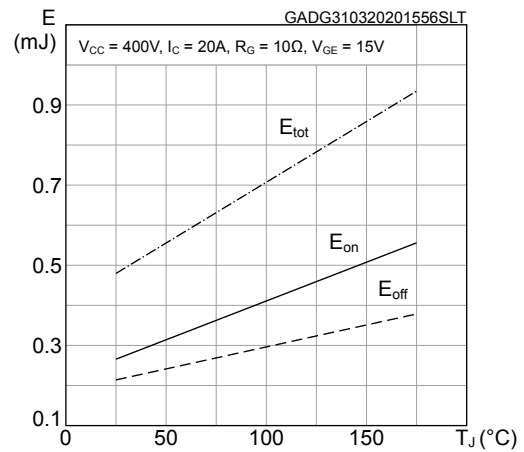

**Figure 17. Switching energy vs collector emitter voltage**

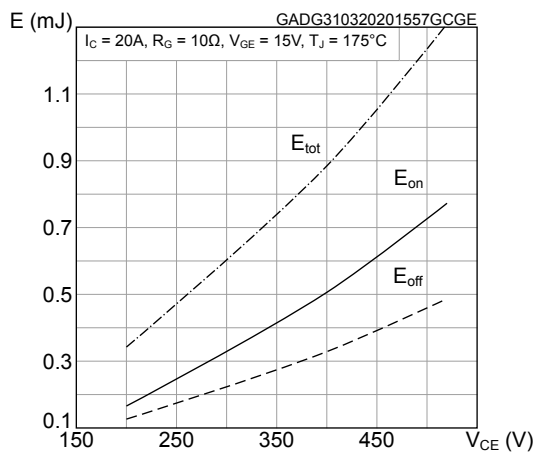

**Figure 18. Switching energy vs gate resistance**

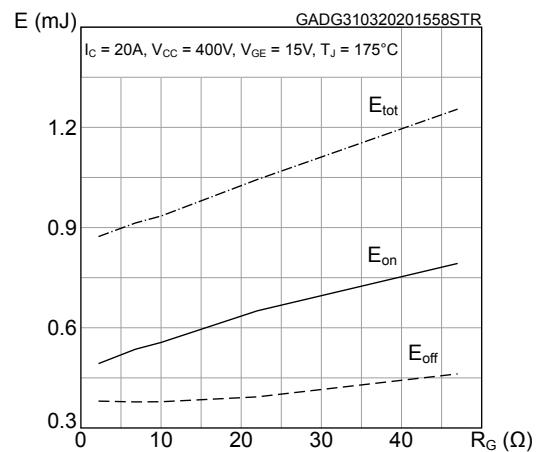

**Figure 19. Switching times vs collector current**

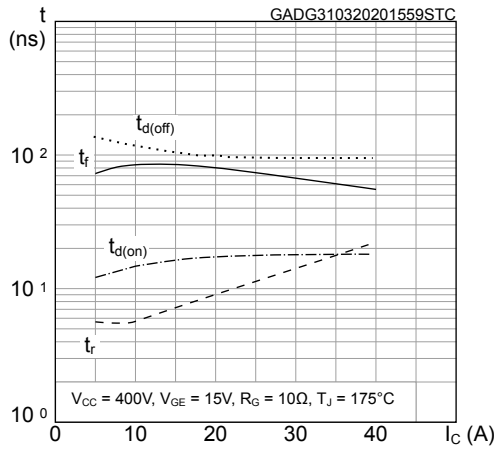

**Figure 20. Switching times vs gate resistance**

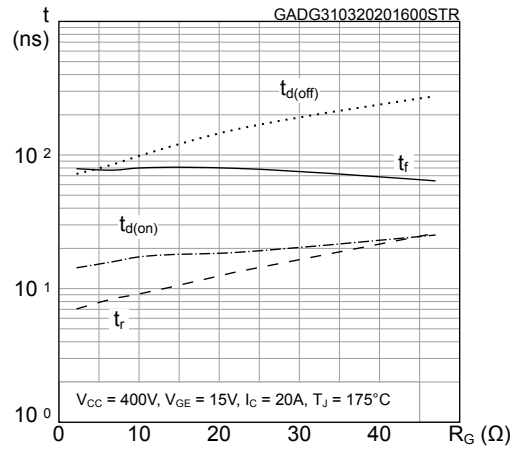

**Figure 21. Reverse recovery current vs diode current slope**

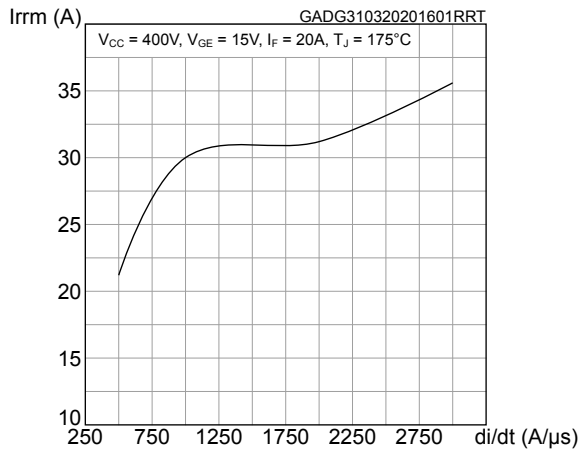

**Figure 22. Reverse recovery time vs diode current slope**

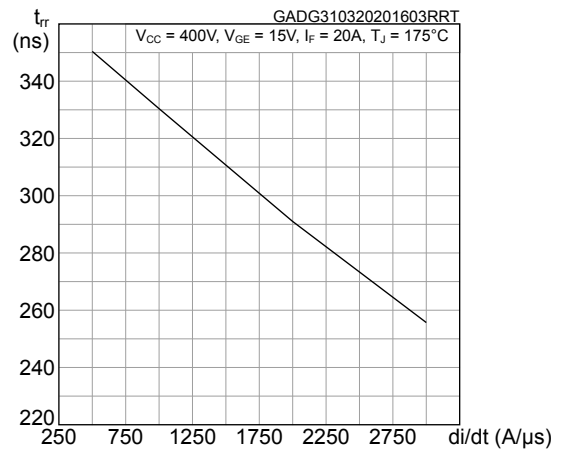

**Figure 23. Reverse recovery charge vs diode current slope**

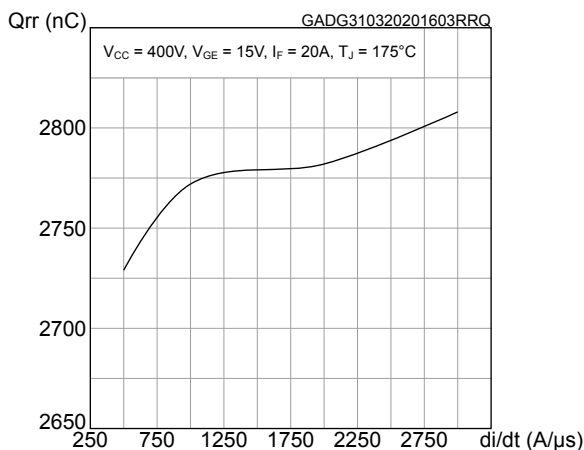

**Figure 24. Reverse recovery energy vs diode current slope**

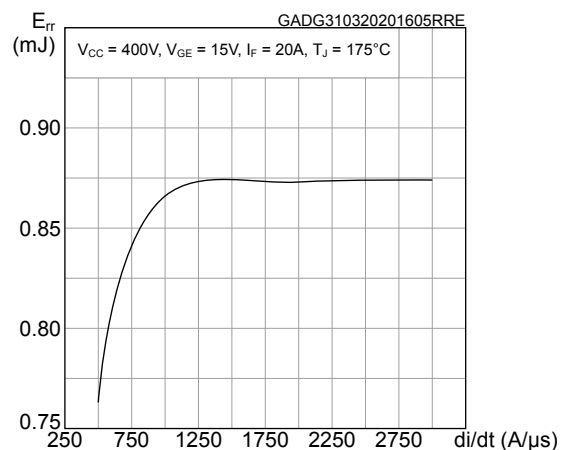

Figure 25. Thermal impedance for IGBT

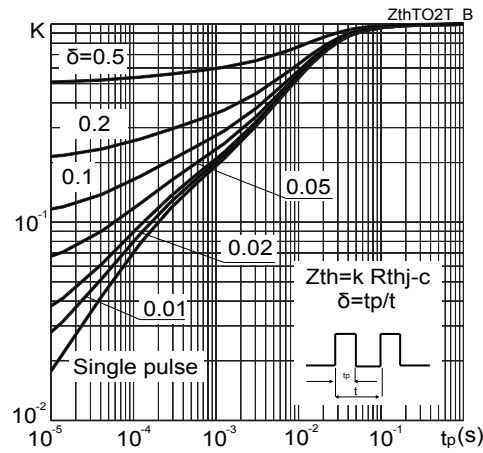
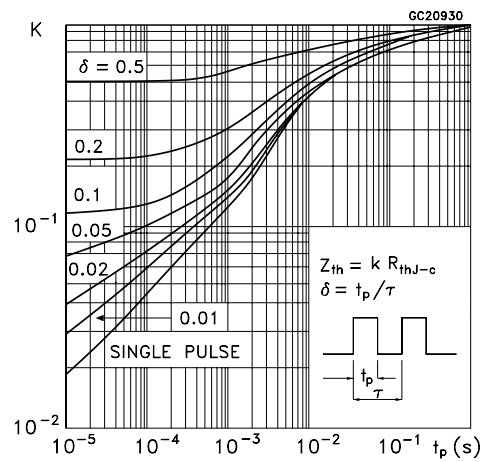
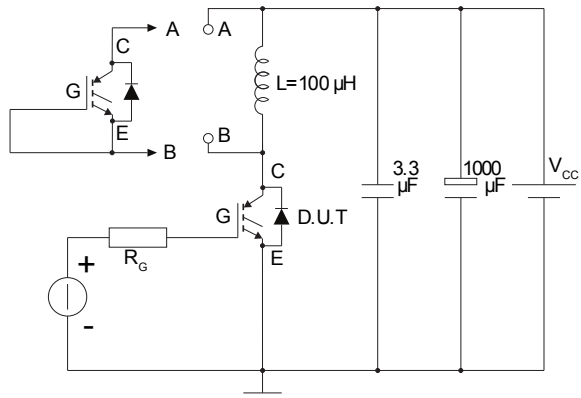

Figure 26. Thermal impedance for diode



### 3 Test circuits

**Figure 27. Test circuit for inductive load switching**

AM01504v1

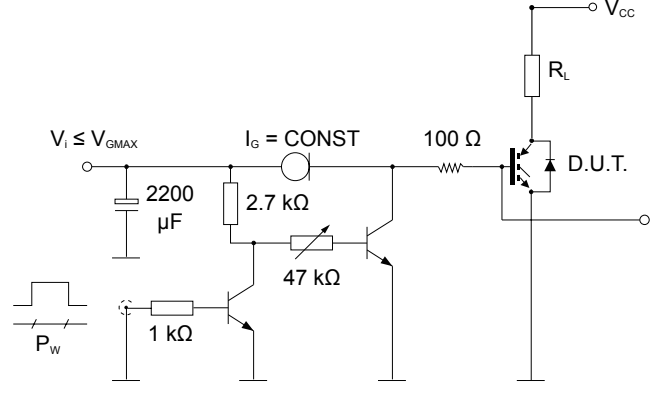
**Figure 28. Gate charge test circuit**

GADG160420181048IG

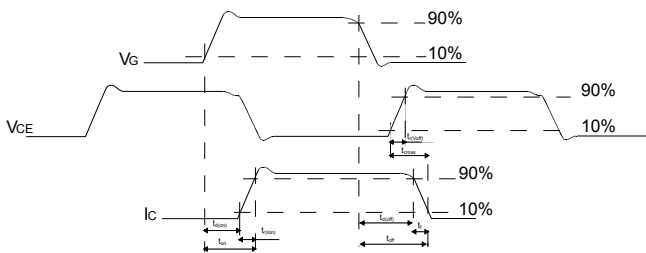
**Figure 29. Switching waveform**

AM01506v1

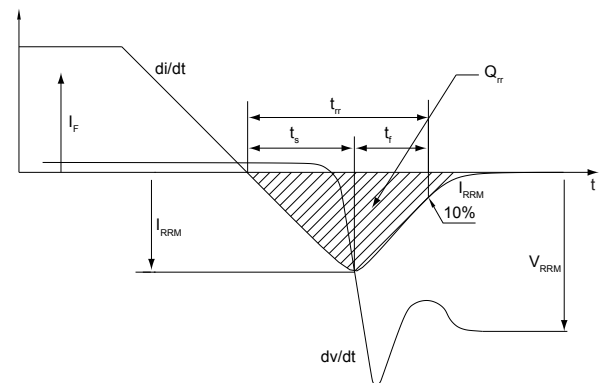
**Figure 30. Diode reverse recovery waveform**

GADG180720171418SA

## 4 Package information

In order to meet environmental requirements, ST offers these devices in different grades of **ECOPACK** packages, depending on their level of environmental compliance. ECOPACK specifications, grade definitions and product status are available at: [www.st.com](http://www.st.com). ECOPACK is an ST trademark.

### 4.1 TO-247 long leads package information

Figure 31. TO-247 long leads package outline

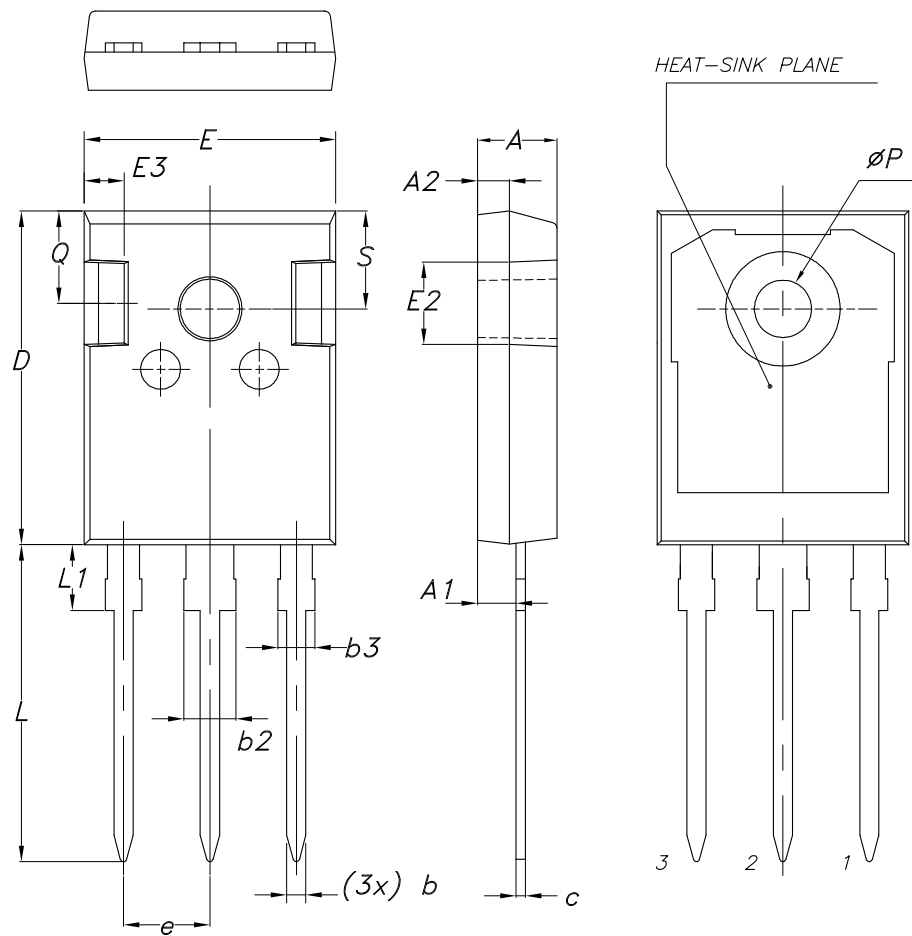

8463846\_2\_F

**Table 7. TO-247 long leads package mechanical data**

Dim.	mm		
	Min.	Typ.	Max.
A	4.90	5.00	5.10
A1	2.31	2.41	2.51
A2	1.90	2.00	2.10
b	1.16		1.26
b2			3.25
b3			2.25
c	0.59		0.66
D	20.90	21.00	21.10
E	15.70	15.80	15.90
E2	4.90	5.00	5.10
E3	2.40	2.50	2.60
e	5.34	5.44	5.54
L	19.80	19.92	20.10
L1			4.30
P	3.50	3.60	3.70
Q	5.60		6.00
S	6.05	6.15	6.25

## Revision history

**Table 8. Document revision history**

Date	Version	Changes
07-Apr-2020	1	First release.

---

## Contents

<b>1</b>	<b>Electrical ratings</b> .....	<b>2</b>
<b>2</b>	<b>Electrical characteristics</b> .....	<b>3</b>
<b>2.1</b>	<b>Electrical characteristics (curves)</b> .....	<b>5</b>
<b>3</b>	<b>Test circuits</b> .....	<b>10</b>
<b>4</b>	<b>Package information</b> .....	<b>11</b>
<b>4.1</b>	<b>TO-247 long leads package information</b> .....	<b>11</b>
	<b>Revision history</b> .....	<b>13</b>

**IMPORTANT NOTICE – PLEASE READ CAREFULLY**

STMicroelectronics NV and its subsidiaries (“ST”) reserve the right to make changes, corrections, enhancements, modifications, and improvements to ST products and/or to this document at any time without notice. Purchasers should obtain the latest relevant information on ST products before placing orders. ST products are sold pursuant to ST’s terms and conditions of sale in place at the time of order acknowledgement.

Purchasers are solely responsible for the choice, selection, and use of ST products and ST assumes no liability for application assistance or the design of Purchasers’ products.

No license, express or implied, to any intellectual property right is granted by ST herein.

Resale of ST products with provisions different from the information set forth herein shall void any warranty granted by ST for such product.

ST and the ST logo are trademarks of ST. For additional information about ST trademarks, please refer to [www.st.com/trademarks](http://www.st.com/trademarks). All other product or service names are the property of their respective owners.

Information in this document supersedes and replaces information previously supplied in any prior versions of this document.

© 2020 STMicroelectronics – All rights reserved