

OMNIMATE Power - series LU LUFS 15.00/04/90V 5.0SN BK BX

Weidmüller Interface GmbH & Co. KG
Klingenbergstraße 26
D-32758 Detmold
Germany
Fon: +49 5231 14-0
Fax: +49 5231 14-292083
www.weidmueller.com

Product image

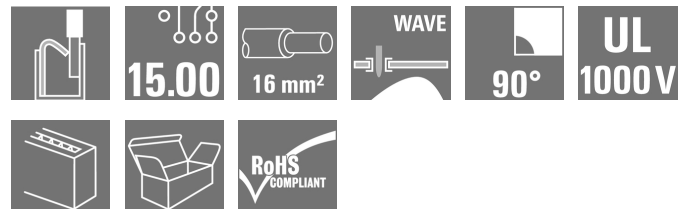

The sturdy, direct connection for extreme current and voltage requirements in all power electronics applications such as solar inverters, frequency converters, servo-controllers and power supplies.

General ordering data

Type	LUFS 15.00/04/90V 5.0SN BK BX
Order No.	2500580000
Version	Printed circuit board terminals, 15.00 mm, Number of poles: 4, 90°, Solder pin length (l): 5 mm, black, PUSH IN without actuator, Clamping range, max.: 16 mm², Box
GTIN (EAN)	4050118604504
Qty.	25 pc(s).
Product data	IEC: 1000 V / 76 A / 0.5 - 16 mm² UL: 600 V / 53 A / AWG 18 - AWG 4
Packaging	Box

Creation date September 9, 2020 11:37:14 AM CEST

OMNIMATE Power - series LU
LUFS 15.00/04/90V 5.0SN BK BX

Weidmüller Interface GmbH & Co. KG
 Klingenbergstraße 26
 D-32758 Detmold
 Germany
 Fon: +49 5231 14-0
 Fax: +49 5231 14-292083
 www.weidmueller.com

Technical data**Dimensions and weights**

Width	56.8 mm	Width (inches)	2.236 inch
Height	35 mm	Height (inches)	1.378 inch
Height of lowest version	30 mm	Depth	28.55 mm
Depth (inches)	1.124 inch	Net weight	46.967 g

System parameters

Product family	OMNIMATE Power - series LU	Wire connection method	PUSH IN without actuator
Mounting onto the PCB	THT solder connection	Conductor outlet direction	90°
Pitch in mm (P)	15 mm	Pitch in inches (P)	0.591 inch
Number of poles	4	Fitted by customer	No
Solder pin length (l)	5 mm	Solder pin dimensions	d = 1.2 mm, Octagonal
Solder eyelet hole diameter (D)	1.7 mm	Solder eyelet hole diameter tolerance (D)	+ 0,1 mm
Number of solder pins per pole	2	Screwdriver blade	0.8 x 4.0
Stripping length	18 mm	L1 in mm	45 mm
L1 in inches	1.772 inch	Touch-safe protection acc. to DIN VDE 0470	IP20 plugged/ IP10 unplugged
Touch-safe protection acc. to DIN VDE 57 106	touch-safe with connected connectors from 6 mm ²		

Material data

Insulating material	Wemid (PA)	Colour	black
Colour of operational elements	orange	Material of operational elements	PA4T GF
Colour chart (similar)	RAL 9011	Insulating material group	I
Comparative Tracking Index (CTI)	≥ 600	Insulation strength	≥ 10 ⁸ Ω
UL 94 flammability rating	V-0	Contact material	E-Cu
Storage temperature, min.	-40 °C	Storage temperature, max.	70 °C
Operating temperature, min.	-40 °C	Operating temperature, max.	120 °C

Conductors suitable for connection

Clamping range, min.	0.5 mm ²
Clamping range, max.	16 mm ²
Wire connection cross section AWG, min.	AWG 18
Wire connection cross section AWG, max.	AWG 4
Solid, min. H05(07) V-U	0.5 mm ²
Solid, max. H05(07) V-U	16 mm ²
Stranded, min. H07V-R	10 mm ²
Stranded, max. H07V-R	16 mm ²
Flexible, min. H05(07) V-K	0.5 mm ²
Flexible, max. H05(07) V-K	16 mm ²
w. plastic collar ferrule, DIN 46228 pt 4, 0.5 mm ² min.	
w. plastic collar ferrule, DIN 46228 pt 4, 16 mm ² max.	
w. wire end ferrule, DIN 46228 pt 1, 0.5 mm ² min.	
w. wire end ferrule, DIN 46228 pt 1, 16 mm ² max.	

OMNIMATE Power - series LU
LUFS 15.00/04/90V 5.0SN BK BX

Weidmüller Interface GmbH & Co. KG
 Klingenbergstraße 26
 D-32758 Detmold
 Germany
 Fon: +49 5231 14-0
 Fax: +49 5231 14-292083
 www.weidmueller.com

Technical data

Clampable conductor	Cross-section for conductor connection	Type	fine-wired
		nominal	2.5 mm ²
wire end ferrule	Stripping length	nominal	20 mm
		Recommended wire-end ferrule	H2.5/25D BL
		Stripping length	nominal 18 mm
		Recommended wire-end ferrule	H2.5/18
Cross-section for conductor connection	Type	fine-wired	
	nominal	4 mm ²	
wire end ferrule	Stripping length	nominal	20 mm
		Recommended wire-end ferrule	H4.0/26D GR
		Stripping length	nominal 18 mm
		Recommended wire-end ferrule	H4.0/18
Cross-section for conductor connection	Type	fine-wired	
	nominal	6 mm ²	
wire end ferrule	Stripping length	nominal	20 mm
		Recommended wire-end ferrule	H6.0/26 SW
		Stripping length	nominal 18 mm
		Recommended wire-end ferrule	H6.0/18
Cross-section for conductor connection	Type	fine-wired	
	nominal	10 mm ²	
wire end ferrule	Stripping length	nominal	21 mm
		Recommended wire-end ferrule	H10.0/28 EB
		Stripping length	nominal 18 mm
		Recommended wire-end ferrule	H10.0/18
Cross-section for conductor connection	Type	fine-wired	
	nominal	16 mm ²	
wire end ferrule	Stripping length	nominal	21 mm
		Recommended wire-end ferrule	H16.0/28 GN
		Stripping length	nominal 18 mm
		Recommended wire-end ferrule	H16.0/18
Cross-section for conductor connection	Type	fine-wired	
	nominal	1.5 mm ²	
wire end ferrule	Stripping length	nominal	20 mm
		Recommended wire-end ferrule	H1.5/24 R
		Stripping length	nominal 18 mm
		Recommended wire-end ferrule	H1.5/18
Reference text	Length of ferrules is to be chosen depending on the product and the rated voltage., The outside diameter of the plastic collar should not be larger than the pitch (P)		
Max. clamping range	16 mm ²		

OMNIMATE Power - series LU
LUFS 15.00/04/90V 5.0SN BK BX

Weidmüller Interface GmbH & Co. KG
 Klingenbergstraße 26
 D-32758 Detmold
 Germany
 Fon: +49 5231 14-0
 Fax: +49 5231 14-292083
 www.weidmueller.com

Technical data**Rated data acc. to IEC**

Rated current, min. number of poles (Tu=20°C)	76 A	Rated current, max. number of poles (Tu=20°C)	76 A
Rated current, min. number of poles (Tu=40°C)	76 A	Rated current, max. number of poles (Tu=40°C)	76 A
Rated voltage for surge voltage class / pollution degree II/2	1,000 V	Rated voltage for surge voltage class / pollution degree III/2	1,000 V
Rated voltage for surge voltage class / pollution degree III/3	1,000 V	Rated impulse voltage for surge voltage class/ pollution degree II/2	6 kV
Rated impulse voltage for surge voltage class/ pollution degree III/2	8 kV	Rated impulse voltage for surge voltage class/ contamination degree III/3	8 kV

Rated data acc. to CSA

Rated voltage (Use group B / CSA)	600 V	Rated voltage (Use group C / CSA)	600 V
Rated voltage (Use group D / CSA)	600 V	Rated current (Use group B / CSA)	53 A
Rated current (Use group C / CSA)	53 A	Rated current (Use group D / CSA)	5 A
Wire cross-section, AWG, min.	AWG 18	Wire cross-section, AWG, max.	AWG 4

Rated data acc. to UL 1059

Institute (cURus)		Certificate No. (cURus)	E60693
Rated voltage (Use group B / UL 1059)	600 V	Rated voltage (Use group C / UL 1059)	600 V
Rated voltage (Use group D / UL 1059)	600 V	Rated voltage (Use group E / UL 1059)	1,000 V
Rated current (Use group B / UL 1059)	53 A	Rated current (Use group C / UL 1059)	53 A
Rated current (Use group D / UL 1059)	5 A	Rated current (Use group E / UL 1059)	53 A
Wire cross-section, AWG, min.	AWG 18	Wire cross-section, AWG, max.	AWG 4
Reference to approval values	Specifications are maximum values, details - see approval certificate.		

Packing

Packaging	Box	VPE length	0 m
VPE width	0 m	VPE height	0 m

Classifications

ETIM 6.0	EC002643	ETIM 7.0	EC002643
eClass 9.0	27-44-04-01	eClass 9.1	27-44-04-01
eClass 10.0	27-44-04-01		

Data sheet

**OMNIMATE Power - series LU
LUFS 15.00/04/90V 5.0SN BK BX**

Weidmüller Interface GmbH & Co. KG
Klingenbergstraße 26
D-32758 Detmold
Germany
Fon: +49 5231 14-0
Fax: +49 5231 14-292083
www.weidmueller.com

Technical data

Notes

Notes	<ul style="list-style-type: none"> • Additional colours on request • Rated current related to rated cross-section & min. No. of poles. • Wire end ferrule without plastic collar to DIN 46228/1 • Wire end ferrule with plastic collar to DIN 46228/4 • P on drawing = pitch • Rated data refer only to the component itself. Clearance and creepage distances to other components are to be designed in accordance with the relevant application standards. • The test point can only be used as potential-pickup point. • Long term storage of the product with average temperature of 50 °C and average humidity 70%, 36 months
IPC conformity	Conformity: The products are developed, manufactured and delivered according international recognized standards and norms and comply with the assured properties in the data sheet resp. fulfill decorative properties in accordance with IPC-A-610 "Class 2". Further claims on the products can be evaluated on request.

Approvals

Approvals	
ROHS	Conform

Downloads

Approval/Certificate/Document of Conformity	Declaration of the Manufacturer
Engineering Data	STEP
White paper power electronics connected correctly	Download Whitepaper
User Documentation	QR-Code product handling video
White paper UL 600 V	Download Whitepaper

OMNIMATE Power - series LU
LUFS 15.00/04/90V 5.0SN BK BX

Weidmüller Interface GmbH & Co. KG
 Klingenbergstraße 26
 D-32758 Detmold
 Germany
 Fon: +49 5231 14-0
 Fax: +49 5231 14-292083
 www.weidmueller.com

Drawings

Product image

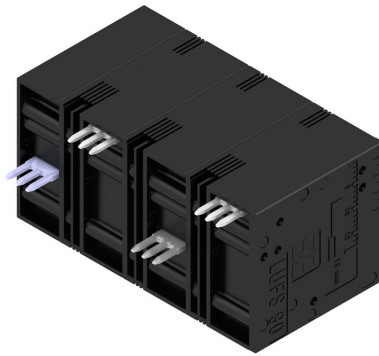

Dimensional drawing

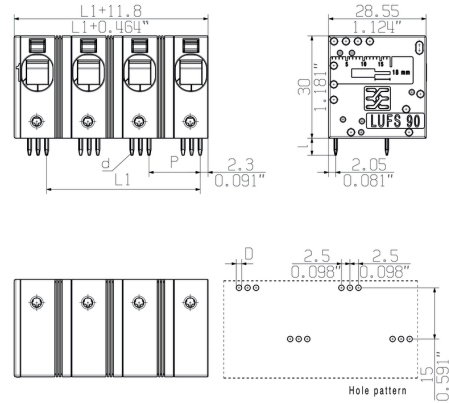

Derating curve

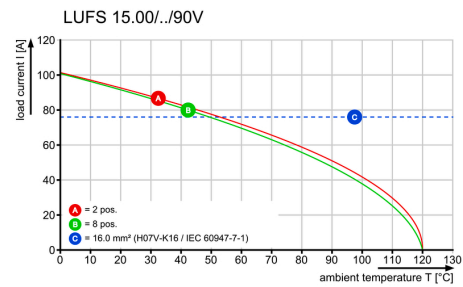

Derating curve

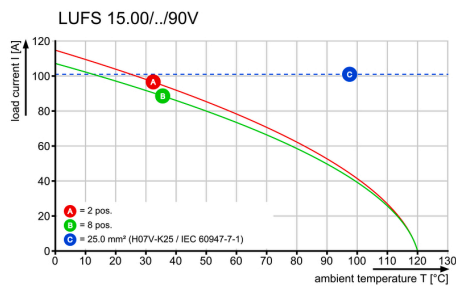

Product benefits



Power up to UL 600 V
Offset solder pins

Allgemeinguetliche Kundenzeichnung, aktueller Stand nur auf Anfrage
 General customer drawing, topical version only if required

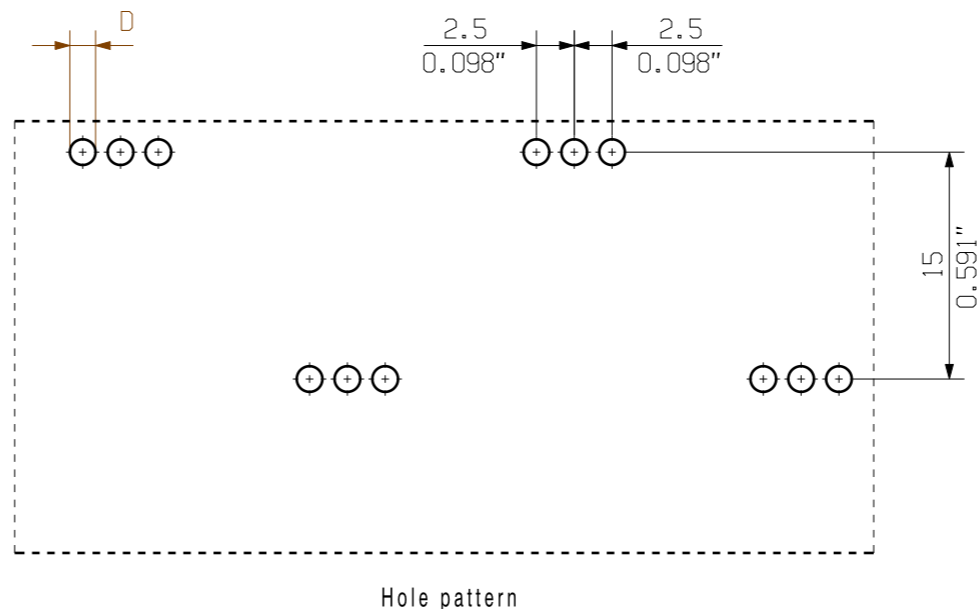
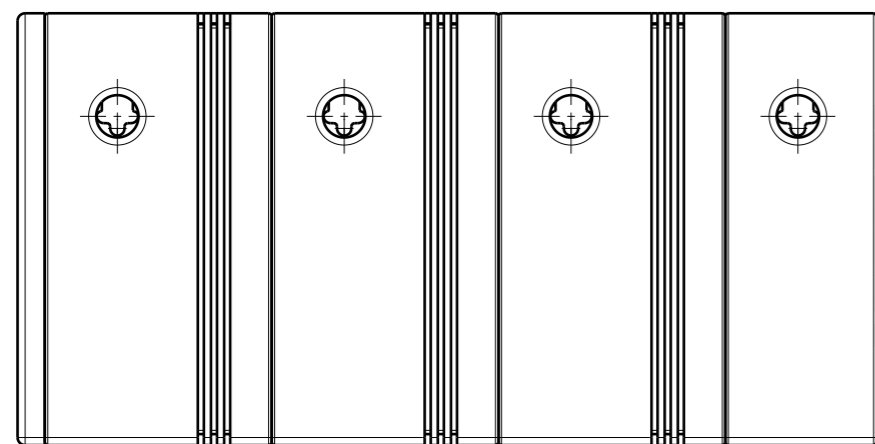
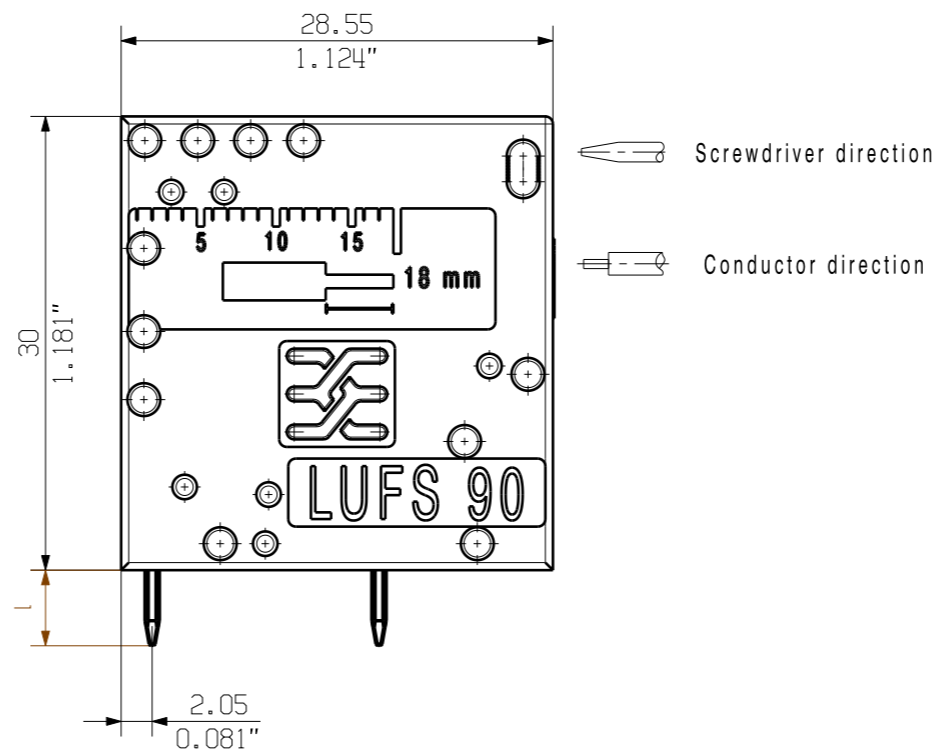
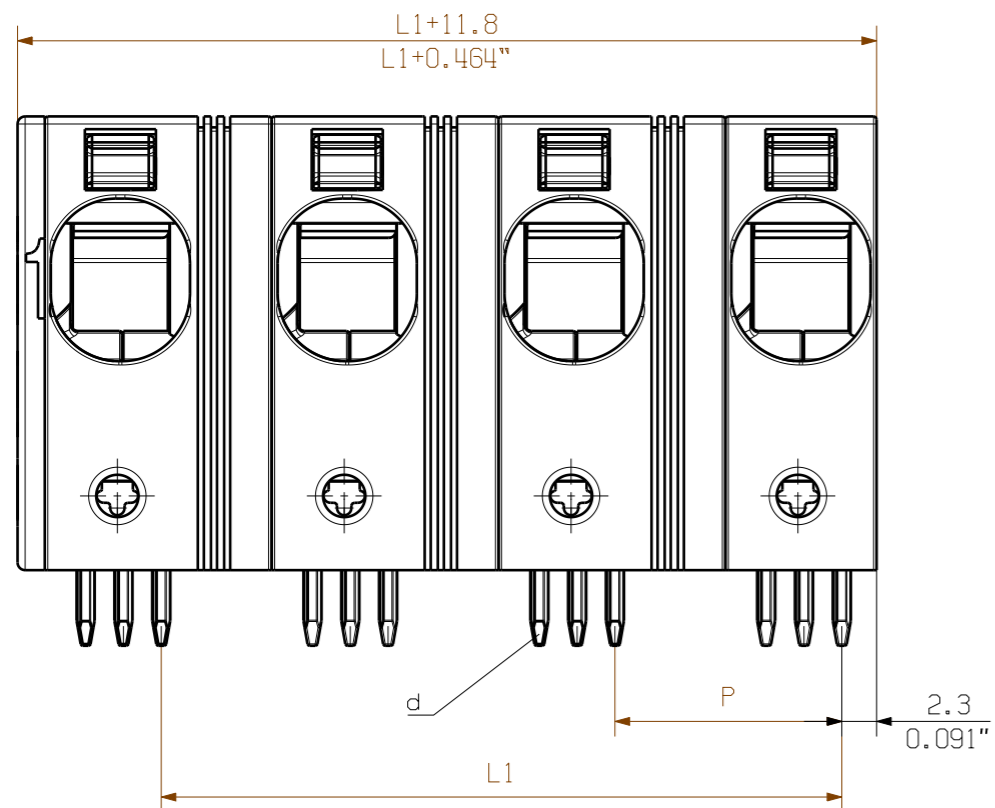

$P = 15.00$ Pitch
 0.590 Raster
 $D = \varnothing 1.7 + 0.1$
 0.066 "
 $d = 1.24 \times 1.2$
 0.049×0.047 "
 $l = 5.0$
 0.197 "

12	165.00	6.496
11	150.00	5.905
10	135.00	5.314
9	120.00	4.724
8	105.00	4.133
7	90.00	3.543
6	75.00	0.952
5	60.00	2.362
4	45.00	1.771
3	30.00	1.181
2	15.00	0.590
n Poles Polzahl	L1 [mm]	L1 [mm]

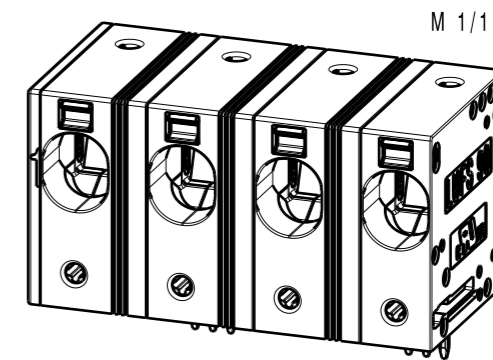

For the mounting of PCBs, it should be noted that the rated data relates only to the PCB components alone.
 The necessary creepage and clearance paths must be observed in connection with the respective applicant in accordance to IEC 664 / VDE 0110.
 The current-carrying capacity and pitch tolerance is to be determined according to DIN IEC 326 part 3 very fine.

Weidmüller PCB components are tested to the DIN EN 61984 standard, and are valid for its field of application. Provided that the components are used to the intended purpose, all requirements with respect to the occurring of electrical, mechanical, thermic and corrosive stress will be satisfied.

General tolerance: DIN ISO 2768-mK 	95782/3 17.08.17 KRECHT_M 01		Cat.no.: .	
	Modification		3 64094 01 Drawing no. Issue no.	
Scale: 2/1 Supersedes: .	Drawn	Date	Name	LIFS 15.00/./90 LEITERPLATTENKLEMME PCB TERMINAL Product file: LUF 10.00
	Responsible	02.12.2016	KRECHT_M	
	Checked	07.09.2017	HELIS_MA	
	Approved		NOLTE_S	7419

Recommended wave soldering profiles

Weidmüller Interface GmbH & Co. KG
 Klingenbergstraße 16
 D-32758 Detmold
 Germany
 Fon: +49 5231 14-0
 Fax: +49 5231 14-292083
 www.weidmueller.com

Single Wave:



Double Wave:



Wave soldering profiles

Wired connection elements should be processed in accordance with the DIN EN 61760-1 standard. We have included two recommendations for practical wave soldering profiles, with which Weidmüller PCB terminals and connectors are qualified.

When choosing a suitable profile for your application, the following factors also need to be considered:

- PCB thickness
- Proportion of Cu in the layers
- Single/double-sided assembly
- Product range
- Heating and cooling rates

The single and double wave profiles each indicate the recommended operating range, including the maximum soldering temperature of 260°C. In practice, the maximum soldering temperature is quite often well below the above maximum profile.