

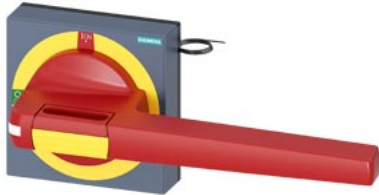





handle with masking plate EMERGENCY-STOP illuminated size 100x 100, for shaft 12x 12, test-0-I, handle size 200mm accessory for 3KD size 5 3KF size 5



Model	
product brand name	SETRON
product designation	handle with masking plate
design of the product	EMERGENCY OFF
design of handle	Red-yellow
design of the door lock system	Door interlocking
size of cross-section of the shaft of door-coupling rotary operating mechanism	12x12 mm
size format of the masking frame of door-coupling rotary operating mechanism	100x 100 mm
length of handle	200 mm
protection class IP	IP65
suitability for use	for 3KD size 5, 3KF size 5
Product details	
product description	with illumination
product feature interlock	Yes
product component	
• extension shaft	No
• handle for emergency-OFF function	Yes
product feature lockable	Yes
Accessories	
accessories	Handle with masking frame
display version for switch position indicator	test-0-I
Mechanical Design	
height	144 mm
width	98 mm
depth	450 mm
Net Weight	699 g
Approvals Certificates	
Environment	General Product Approval
Environmental Confirmations	    
Maritime application	other

Further information

Information on the packaging

<https://support.industry.siemens.com/cs/ww/en/view/109813875>

Information for data generation and storage

<https://support.industry.siemens.com/cs/ww/en/view/109995012>

Information- and Downloadcenter (Catalogs, Brochures,...)

<https://www.siemens.com/lowvoltage/catalogs>

Industry Mall (Online ordering system)

<https://mall.industry.siemens.com/mall/en/en/Catalog/product?mlfb=8UD1861-4CF05>

Service&Support (Manuals, Certificates, Characteristics, FAQs,...)

<https://support.industry.siemens.com/cs/ww/en/ps/8UD1861-4CF05>

Image database (product images, 2D dimension drawings, 3D models, device circuit diagrams, ...)

https://www.automation.siemens.com/bilddb/cax_en.aspx?mlfb=8UD1861-4CF05

CAX-Online-Generator

<https://www.siemens.com/cax>

Tender specifications

<https://www.siemens.com/specifications>

Characteristic curves

[https://curves.simaris.siemens.com/curves/<mmp_prod_noCOMP="HAUPT"></mmp_prod_no>](https://curves.simaris.siemens.com/curves/<mmp_prod_noCOMP=)

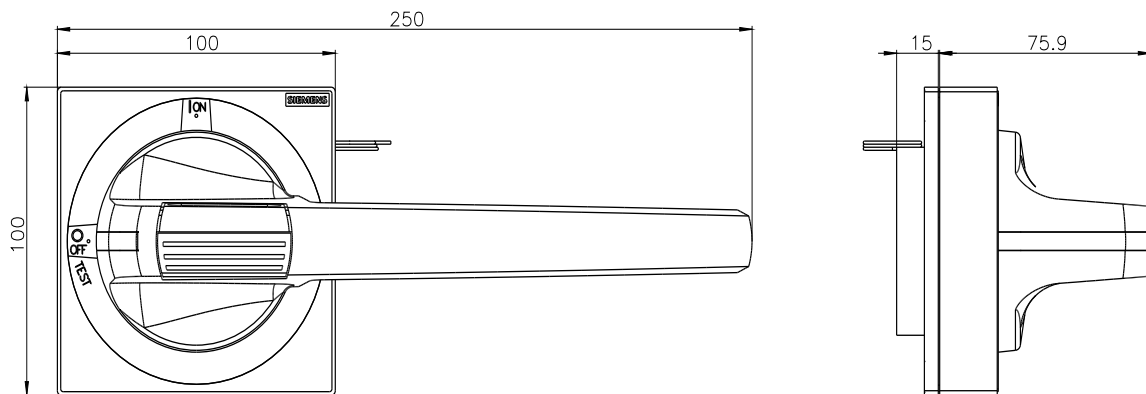

last modified:

4/4/2025

