







Handle with masking frame standard Size 75x 75, for shaft 8x 8, 0-I, Handle size 55 mm, 3LD5 UL

Model	
product brand name	SETRON
product designation	handle with masking plate
design of the product	standard
design of handle	Gray
design of the door lock system	Door interlocking
size of cross-section of the shaft of door-coupling rotary operating mechanism	8x8 mm
size format of the masking frame of door-coupling rotary operating mechanism	75x 75 mm
length of handle	55 mm
protection class IP	IP65
suitability for use	for 3LD5 UL
Product details	
product description	without lighting
product feature interlock	Yes
product component	
• extension shaft	No
• handle for emergency-OFF function	No
product feature lockable	Yes
Accessories	
accessories	Handle with masking frame
display version for switch position indicator	0-I
Mechanical Design	
height	105 mm
width	88 mm
depth	445 mm
Net Weight	174 g
Approvals Certificates	
Environment	General Product Approval
<a href="#">Environmental Confirmations</a>	    
General Product Approval	Maritime application    other

## Further information

## Information on the packaging

<https://support.industry.siemens.com/cs/ww/en/view/109813875>

## Information for data generation and storage

<https://support.industry.siemens.com/cs/ww/en/view/109995012>

## Information- and Downloadcenter (Catalogs, Brochures,...)

<https://www.siemens.com/lowvoltage/catalogs>

## Industry Mall (Online ordering system)

<https://mall.industry.siemens.com/mall/en/en/Catalog/product?mlfb=8UD1731-2AD01>

## Service&amp;Support (Manuals, Certificates, Characteristics, FAQs,...)

<https://support.industry.siemens.com/cs/ww/en/ps/8UD1731-2AD01>

## Image database (product images, 2D dimension drawings, 3D models, device circuit diagrams, ...)

[https://www.automation.siemens.com/bilddb/cax\\_en.aspx?mlfb=8UD1731-2AD01](https://www.automation.siemens.com/bilddb/cax_en.aspx?mlfb=8UD1731-2AD01)

## CAx-Online-Generator

<https://www.siemens.com/cax>

## Tender specifications

<https://www.siemens.com/specifications>

## Characteristic curves

[https://curves.simaris.siemens.com/curves/<mmp\\_prod\\_noCOMP="HAUPT"></mmp\\_prod\\_no>](https://curves.simaris.siemens.com/curves/<mmp_prod_noCOMP=)

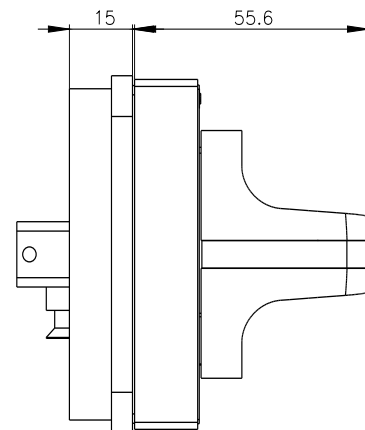
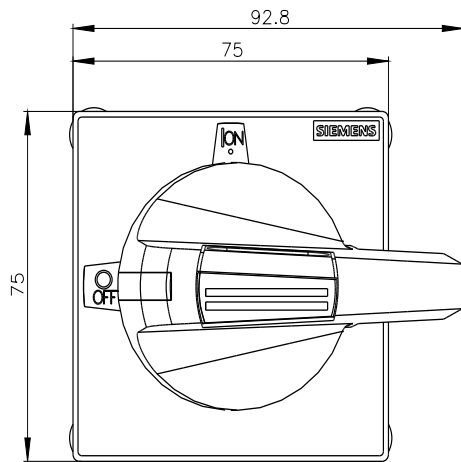

last modified:

4/4/2025 

