

Click to  
**ORDER**  
samples

AME15-VZ



Encapsulated

The new AME15-VZ is a brand-new AC/DC converter that offers much greater cost effectiveness due to material normalization and production automation also leading to improved reliability and performance. Offering a commercial input voltage range of 85-264VAC and an output voltage range from 3.3-24V, this series will offer many benefits to your new system design.

This new series offers great operating temperatures, from -40°C to 85°C with full power up to 55°C. It also features an isolation of 4000VAC for improved reliability and system safety. Furthermore, a higher MTBF of 300,000h, output short circuit protection (OSCP), output over-current protection (OCP) and an output over-voltage protection (OVP) come standard with the series.

The AME15-VZ is perfect for street lighting controls, grid power, LED, instrumentation, industrial controls, communication and civil applications.

Features



- Universal Input: 85 - 264VAC/120 - 370VDC
- Operating Temp: -40 °C to +85 °C
- High isolation voltage: 4000VAC
- Low ripple & noise, 50mV(p-p), typ.
- Output short circuit, over-current, over-voltage protection
- Efficiency up to 83%

Summary

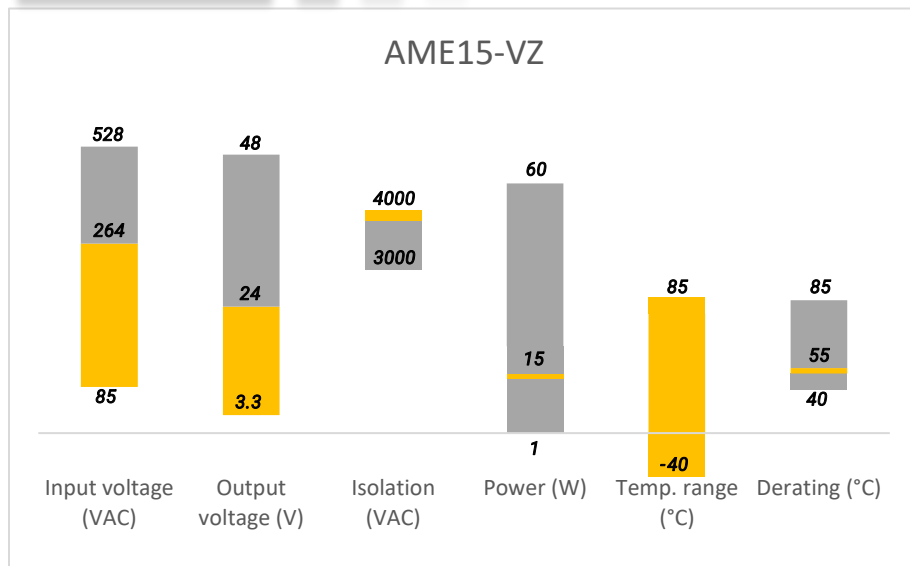

Training



Product Training Video  
(click to open)

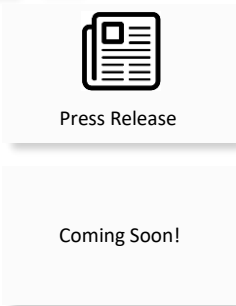

Application Notes

Applications

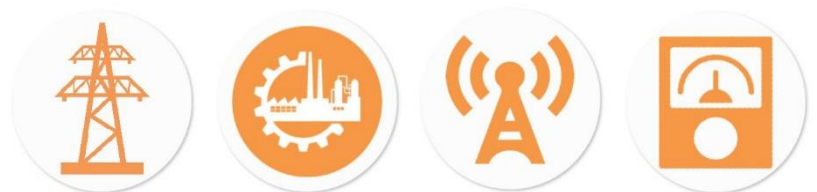

Power Grid

Industrial

Telecom

Instrumentation

## Models & Specifications

Single Output						
Model	Input Voltage (VAC/Hz)	Input Voltage (VDC)	Output Voltage (V)	Output Current max (A)	Maximum capacitive Load (μF)	Efficiency (%)
						230 VAC
AME15-3.3SVZ	85-264/47-63	100-370	3.3	3.0	40000	73
AME15-5SVZ	85-264/47-63	100-370	5	2.8	20000	76
AME15-9SVZ	85-264/47-63	100-370	9	1.6	5800	78
AME15-12SVZ	85-264/47-63	100-370	12	1.25	5200	80
AME15-15SVZ	85-264/47-63	100-370	15	1.0	4500	80
AME15-24SVZ	85-264/47-63	100-370	24	0.625	1000	83

Note: Add suffix “-ST” for optional screw terminal bottom plate or “-STD” for optional DIN Rail screw terminal bottom plate.

Input Specifications					
Parameters	Conditions	Minimum	Typical	Maximum	Units
Current (full load)	115 VAC			370	mA
	230 VAC			220	mA
Inrush current <2ms (cold start)	115 VAC		16		A
	230 VAC		30		A
External fuse	Recommended slow blow type	2			A

Output Specifications				
Parameters	Conditions	Typical	Maximum	Units
Voltage accuracy	3.3VDC output	±3		%
	Other output	±2		
Line regulation	Full load, main output	±0.5		%
Load regulation (single output)	0-100% load	±1		%
Minimum load		0		%
Ripple & Noise *		50	100	mV p-p
Hold-up time	115VAC, 20MHz bandwidth	10		ms
	230VAC, 20MHz bandwidth	60		ms

\*Ripple and Noise are measured at 20MHz bandwidth & 230VAC with the recommended Application Circuit.

Isolation Specifications				
Parameters	Conditions	Typical	Rated	Units
Tested I/O voltage	60 sec		4000	VAC

General Specifications				
Parameters	Conditions	Typical	Maximum	Units
Protection class	Class II			
Over current protection		≥150		% of I <sub>out</sub>
Over voltage protection	Zener diode clamp	≥110		% of I <sub>out</sub>
Short circuit protection	Continuous, Auto recovery			
Operating temperature	See derating curve	-40 to +85		°C
Storage temperature		-40 to +105		°C
Maximum Case temperature			100	°C
Temperature coefficient		±0.02		% / °C
Cooling	Free air convection			
Humidity	Non-condensing		95	%
Case material	Plastic (flammability to UL 94V-0)		95	% RH
Weight	PCB mountable model:	90		g
	With optional -ST mounting plate:	140		
	With optional -STD mounting plate:	180		
Dimensions (L x W x H)	PCB mountable model:	2.44 x 1.77 x 0.89 inches (62 x 45 x 22.5mm)		
	With optional -ST mounting plate:	3.78 x 2.13 x 1.22 inches (96.1 x 54 x 31 mm)		
	With optional -STD mounting plate:	3.78 x 2.12 x 1.40 inches (96.1 x 54 x 35 mm)		
MTBF	> 300,000 hrs (MIL-HDBK -217F, t <sub>a</sub> =+25°C)/Full Load			

NOTE: All specifications in this datasheet are measured at an ambient temperature of 25°C, humidity<75%, nominal input voltage and at rated output load unless otherwise specified.

Safety Specifications		
Parameters		
Agency approvals	cULus, CE	
Standards	Information technology Equipment	UL 62368
	EMI - Conducted and radiated emission	CISPR32/EN55032, class B
	Electrostatic Discharge Immunity	IEC 61000-4-2, Contact ±6kV/Air ±8kV, Criteria B
	RF, Electromagnetic Field Immunity	IEC 61000-4-3, 10V/m, Criteria A
	Electrical Fast Transient/Burst Immunity	IEC 61000-4-4, ±2kV, ±4kV with external circuit, Criteria B
	Surge Immunity	IEC 61000-4-5 L to L ±1kV, L to L ±2kV/L to G ±4kV with external circuit, Criteria B
	RF, Conducted Disturbance Immunity	IEC 61000-4-6 10Vr.m.s, Criteria A
Voltage dips, Short Interruptions Immunity	IEC 61000-4-11 0%, 70%, Criteria B	

Derating

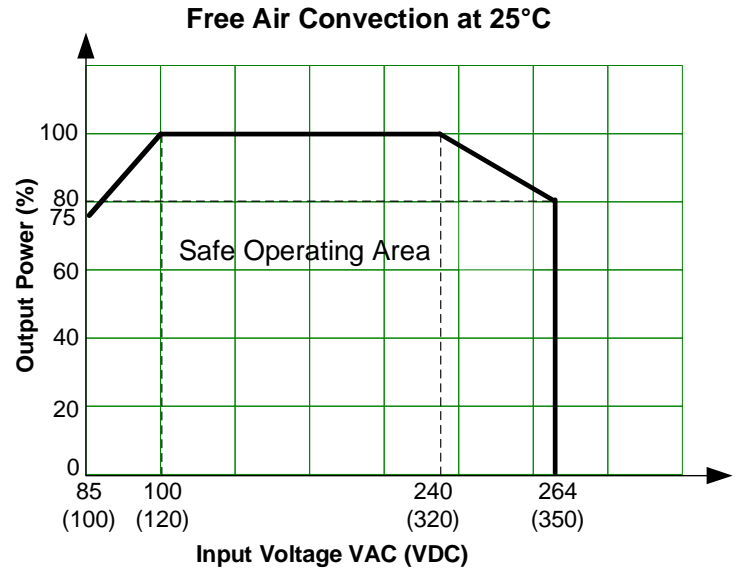
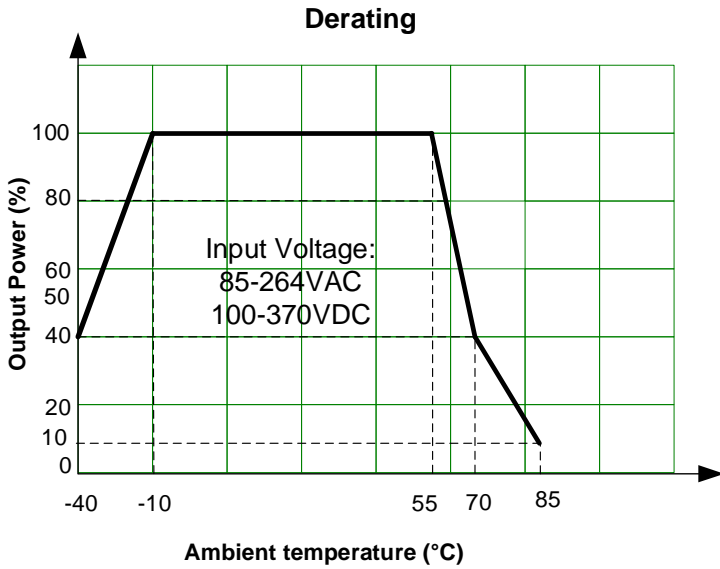

Typical Application Circuit

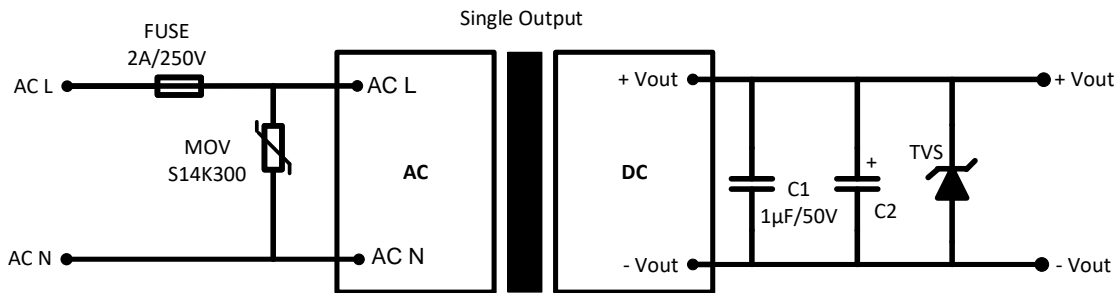

## EMC Recommended Circuit

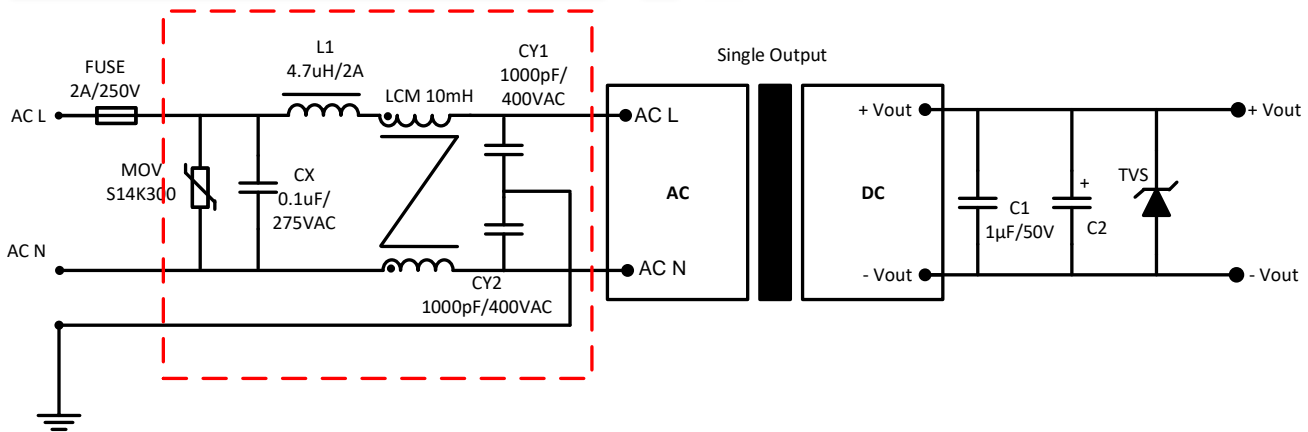

Model	C2	TVS
3.3 Vout	680 $\mu$ F	7V
5 Vout	680 $\mu$ F	7V
9 Vout	470 $\mu$ F	12V
12 Vout	220 $\mu$ F	20V
15 Vout	220 $\mu$ F	20V
24 Vout	68 $\mu$ F	30V

## Dimensions

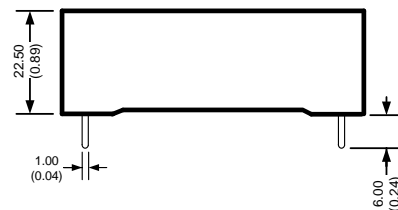
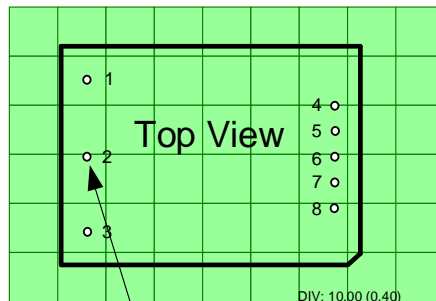
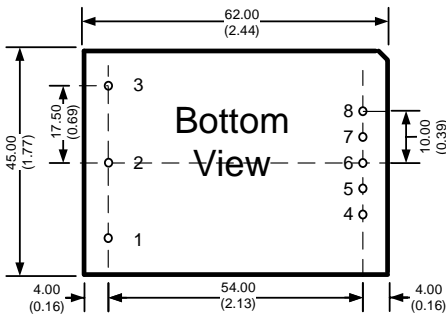

Dimensions mm (inch)  
Case Tolerance  $\pm 0.50$  ( $\pm 0.02$ )  
Pin Diameter  $1.0 \pm 0.10$  ( $0.04 \pm 0.004$ )

Pin Out Specifications	
Pin	Single
1	No pin
2	AC Input (N)
3	AC Input (L)
4	-V Output
5	No pin
6	No pin
7	No pin
8	+V Output

With optional -ST bottom plate

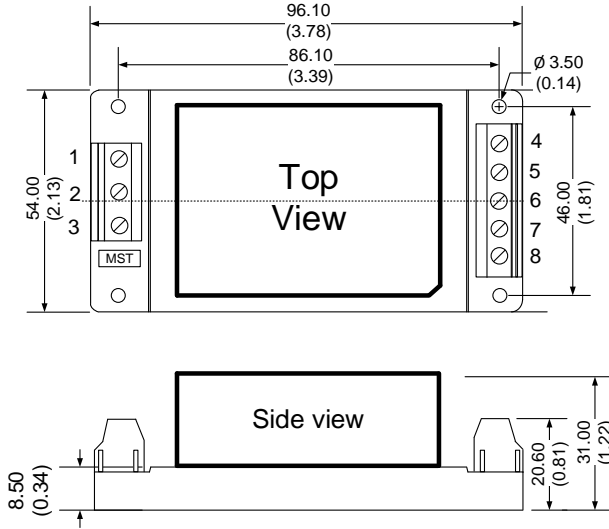

Dimensions: mm (inch)  
Case Tolerance:  $\pm 1.00$  (0.04)  
Holding holes tolerance:  $\pm 0.20$  (0.01)  
Wire gauge: 24-12AWG

With optional -STD bottom plate

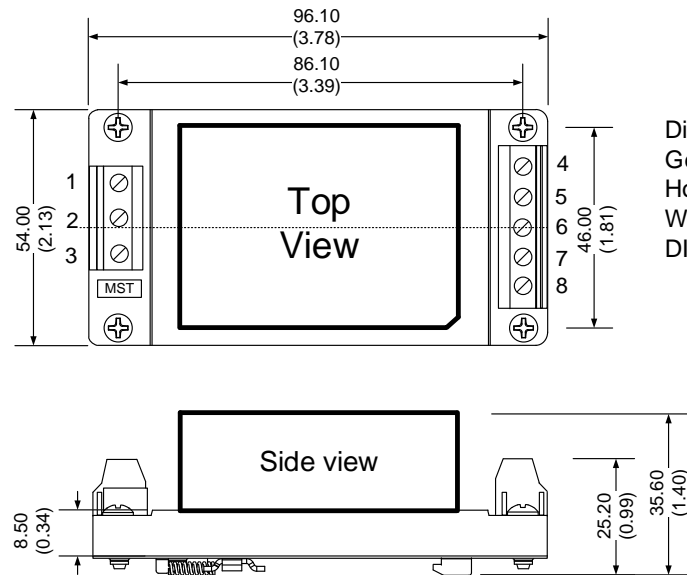

Dimensions: mm (inch)  
General Tolerance:  $\pm 1.00$  (0.04)  
Holding holes tolerance:  $\pm 0.20$  (0.01)  
Wire gauge: 24-12AWG  
DIN rail type: TS35

**NOTE:** **1.** Datasheets are updated as needed and as such, specifications are subject to change without notice. Once printed or downloaded, datasheets are no longer controlled by Aimtec; refer to [www.aimtec.com](http://www.aimtec.com) for the most current product specifications. **2.** Product labels shown, including safety agency certifications on labels, may vary based on the date manufactured. **3.** Mechanical drawings and specifications are for reference only. **4.** All specifications are measured at an ambient temperature of 25°C, humidity < 75%, nominal input voltage and at rated output load unless otherwise specified. **5.** Aimtec may not have conducted destructive testing or chemical analysis on all internal components and chemicals at the time of publishing this document. CAS numbers and other limited information are considered proprietary and may not be available for release. **6.** This product is not designed for use in critical life support systems, equipment used in hazardous environments, nuclear control systems or other such applications which necessitate specific safety and regulatory standards other than the ones listed in this datasheet. **7.** Warranty is in accordance with Aimtec's standard Terms of Sale available at [www.aimtec.com](http://www.aimtec.com).