



Main

Product Range	Legacy
Product Type	Power relay
Switch Function	SPDT
Contact Composition	1 NC + 1 NO

Complementary

Input Current	15 A
Contacts Material	Silver alloy, gold flashed
Local Signalling	Flag
Minimum Switching Current	10 mA at 17 V
Coil Resistance	115 Ohm
Input Voltage	12 V DC
Drop-out Voltage Threshold	$\geq 0.15 U_c$ AC $\geq 0.1 U_c$ DC
Rated Operational Current	15 A at 120...277 V AC conforming to UL 15 A at 28 V DC conforming to UL 15 A at 120/150 V AC conforming to CSA 10 A at 151/277 V AC conforming to CSA 15 A at 28 V DC conforming to CSA 15 A at 250 V AC (NO) conforming to IEC 15 A at 28 V DC (NO) conforming to IEC 7.55 A at 250 V AC (NC) conforming to IEC 7.55 A at 28 V DC (NC) conforming to IEC
Power consumption in W	1.1 W DC
Power consumption in VA	1.6 VA AC
Voltage Range	0.8...1.1 U_n AC/DC
Maximum Switching Voltage	300 V AC conforming to UL 300 V AC conforming to CSA 250 V AC IEC
Motor Power HP	0.5 Hp at 120 V AC 50...60 Hz 1 hp at 277 V AC 50...60 Hz
Connections Terminals	Faston terminals
Mounting	Socket
Height	1.39 in (35.3 mm)
Width	0.55 in (14 mm)
Depth	1.07 in (27.3 mm)
Product Weight	0.92 oz (26 g)
Operating Time	25 ms 20 ms

Environment

Ambient Air Temperature for Operation	-40...131 °F (-40...55 °C)
Ambient Air Temperature for Storage	-40...185 °F (-40...85 °C)
Product Certifications	UL CE CSA
Electrical Durability	100000 cycles resistive
Mechanical Durability	10000000 cycles
Dielectric Strength	2000 V AC between coil and contact 2000 V AC between poles 1500 V AC between contacts
Shock Resistance	15 gn in operation
Vibration Resistance	+/-1 mm (f = 10...35 Hz) 3 gn (f = 35...150 Hz)

Ordering and shipping details

GTIN	03606480780431
------	----------------

Offer Sustainability

Sustainable offer status	Green Premium product
California proposition 65	WARNING: This product can expose you to chemicals including: Nickel compounds, which is known to the State of California to cause cancer, and Di-isodecyl phthalate (DIDP), which is known to the State of California to cause birth defects or other reproductive harm. For more information go to www.P65Warnings.ca.gov
REACH Regulation	REACH Declaration
REACH free of SVHC	Yes
EU RoHS Directive	Pro-active compliance (Product out of EU RoHS legal scope) EU RoHS Declaration
Toxic heavy metal free	Yes
Mercury free	Yes
RoHS exemption information	Yes
China RoHS Regulation	China RoHS Declaration
Environmental Disclosure	Product Environmental Profile
WEEE	The product must be disposed on European Union markets following specific waste collection and never end up in rubbish bins.

Approximate Dimensions

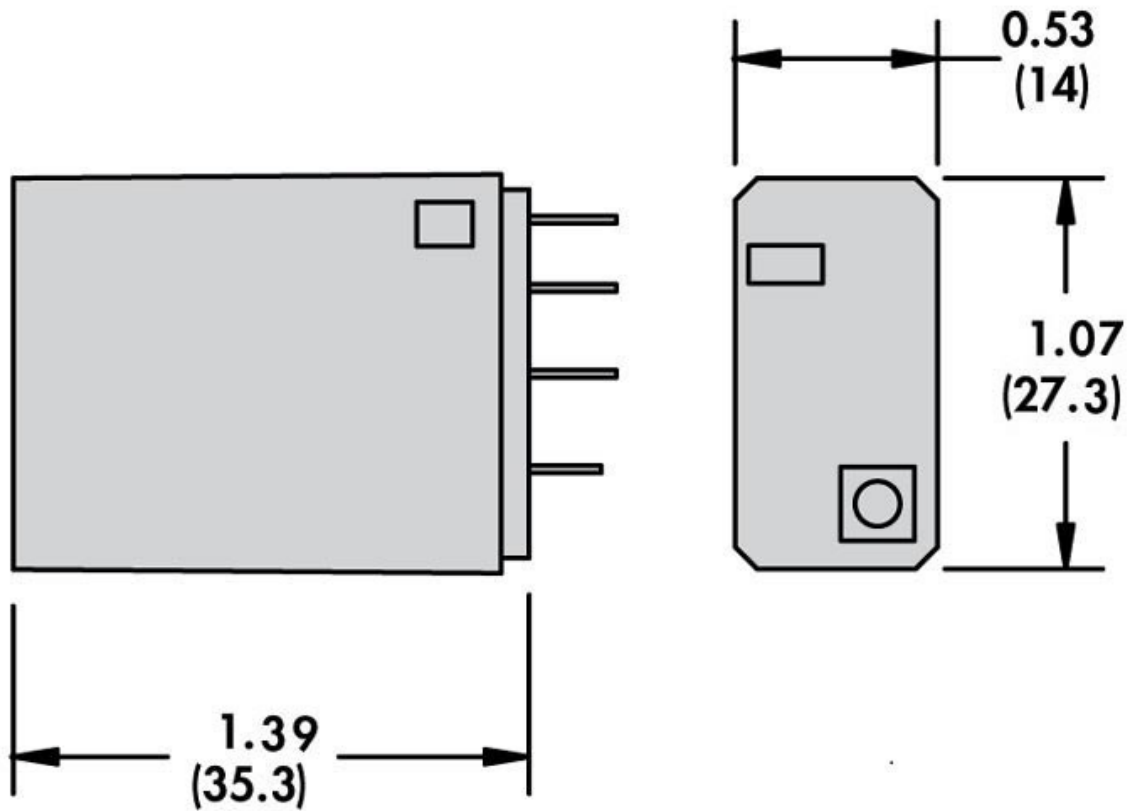

Connections and Wiring Diagrams

