

busbar system, accessory busbar center-to-center spacing 40, 60 mm connection terminal busbar thickness: 5 mm 16-120 mm²

Model	
product brand name	SENTRON
product designation	Connecting terminal
design of the product	Accessories
Supply voltage	
operating voltage at AC rated value	690 V
Dissipation	
power loss [W]	0 W
suitability for use	for busbars 12, 15, 20, 25, 30 x 5 mm and mounting rails
according UL	
operational current according to UL 508 rated value	255 A
Connections	
type of connectable conductor cross-sections for AWG cables	AWG 4MCM250
type of connectable conductor cross-sections for copper conductor stranded	16-120 mm ²
type of connectable conductor cross-sections of the laminated conductor rails	4x15.5x0.8 mm or 6x15.5x0.8 mm or 10x15.5x0.5 mm
Mechanical Design	
Net Weight	100 g
Approvals Certificates	
Environment	General Product Approval

[Environmental Confirmations](#)

[Environmental Confirmations](#)



[Confirmation](#)

General Product Approval

Test Certificates

other



[Miscellaneous](#)

[Miscellaneous](#)

[Confirmation](#)



Further information

Information on the packaging

<https://support.industry.siemens.com/cs/ww/en/view/109813875>

Information for data generation and storage

<https://support.industry.siemens.com/cs/ww/en/view/109995012>

Information- and Downloadcenter (Catalogs, Brochures,...)

<https://www.siemens.com/lowvoltage/catalogs>

Industry Mall (Online ordering system)

<https://mall.industry.siemens.com/mall/en/en/Catalog/product?mlfb=8US1921-2AC01>

Service&Support (Manuals, Certificates, Characteristics, FAQs,...)

<https://support.industry.siemens.com/cs/ww/en/ps/8US1921-2AC01>

Image database (product images, 2D dimension drawings, 3D models, device circuit diagrams, ...)

https://www.automation.siemens.com/bilddb/cax_en.aspx?mlfb=8US1921-2AC01

CAx-Online-Generator

<https://www.siemens.com/cax>

Tender specifications

<https://www.siemens.com/specifications>

Characteristic curves

https://curves.simaris.siemens.com/curves/<mmp_prod_noCOMP='HAUPT'></mmp_prod_no>

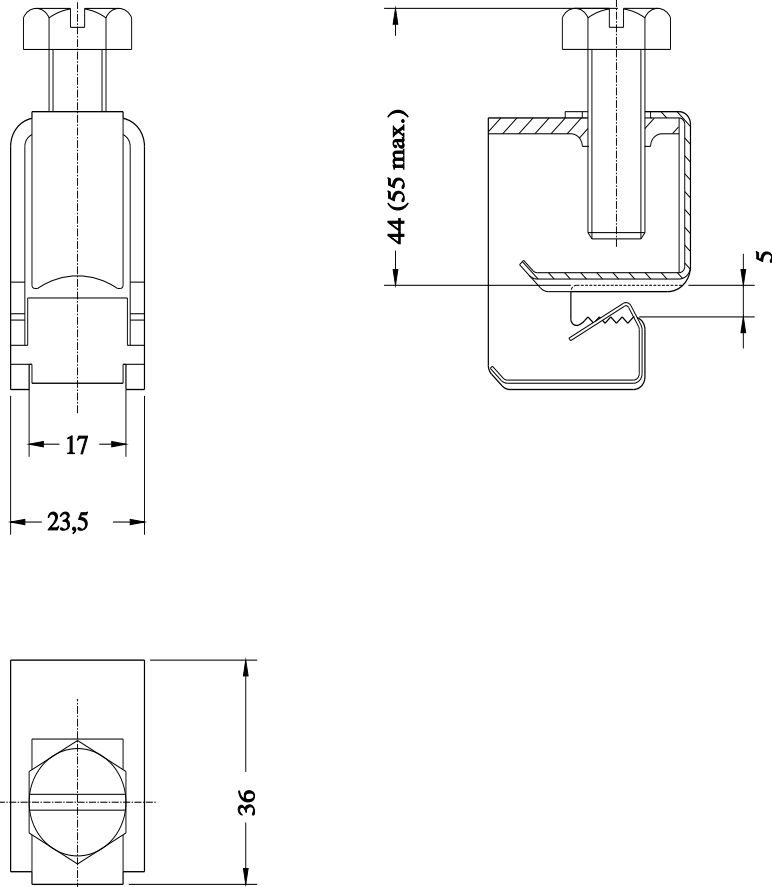

last modified:

5/22/2025

