



basic device SIMOCODE pro S, PROFIBUS DP interface 1.5 Mbps, 4 I/2 O freely configurable, Us: 24 V DC, input for thermistor connection monostable relay outputs, expandable by a multifunction module

product brand name	SIMOCODE
product designation	Motor management system
design of the product	Basic device 0
product type designation	pro S
General technical data	
certificate of suitability	CE / UL / CSA / C-Tick (RCM) / GOST / NOM / ATEX
product function	
• current measurement	No
• voltage measurement	No
• active power measurement	No
• energy measurement	No
• frequency measurement	No
• bus communication	Yes
• data acquisition function	Yes
• diagnostics function	Yes
• password protection	Yes
• test function	Yes
• maintenance function	Yes
• MRRT redundancy procedure	No
product component	
• input for thermistor connection	Yes
• digital input	Yes
• input for analog temperature sensors	No
• input for ground fault detection	No
• relay output	Yes
product extension	
• temperature monitoring module	Yes
• current measuring module	Yes
• current/voltage measuring module	No
• fail-safe digital I/O module	No
• ground-fault monitoring module	Yes
• decoupling module	No
• analog I/O module	No
• digital I/O module with monostable outputs	Yes
• digital I/O module with bistable outputs	No
• control unit with display	No
• control unit	Yes
consumed active power	2.1 W
insulation voltage with degree of pollution 3 at AC rated value	300 V

surge voltage resistance rated value	4 000 V
shock resistance	
<ul style="list-style-type: none"> when mounted on current measuring module according to IEC 60068-2-27 	10 g / 11 ms
<ul style="list-style-type: none"> according to IEC 60068-2-27 	15 g / 11 ms
<ul style="list-style-type: none"> vibration resistance 	1 ... 6 Hz / 15 mm; 6 ... 500 Hz / 2 g
<ul style="list-style-type: none"> vibration resistance when mounted on current measuring module according to IEC 60068-2-6 	1 ... 4 Hz / 15 mm, 4 ... 500 Hz / 1g
switching capacity current of the NO contacts of the relay outputs at AC-15	
<ul style="list-style-type: none"> at 24 V 	6 A
<ul style="list-style-type: none"> at 120 V 	6 A
<ul style="list-style-type: none"> at 230 V 	3 A
switching capacity current of the NO contacts of the relay outputs at DC-13	
<ul style="list-style-type: none"> at 24 V 	2 A
<ul style="list-style-type: none"> at 60 V 	0.55 A
<ul style="list-style-type: none"> at 125 V 	0.25 A
mechanical service life (operating cycles) typical	10 000 000
electrical endurance (operating cycles) typical	100 000
buffering time in the event of power failure	0.05 s
reference code according to IEC 81346-2	F
continuous current of the NO contacts of the relay outputs	
<ul style="list-style-type: none"> at 50 °C 	6 A
<ul style="list-style-type: none"> at 60 °C 	5 A
type of input characteristic	Type 1 in accordance with EN 61131-2
Substance Prohibition (day/month/year)	05/01/2012
SVHC substance name	Lead CAS-No. 7439-92-1 Lead monoxide (lead oxide) CAS-No. 1317-36-8 2,2',6,6'-tetrabromo-4,4'-isopropylidenediphenol CAS-No. 79-94-7 2-methyl-1-(4-methylthiophenyl)-2-morpholinopropan-1-one CAS-No. 71868-10-5 Melamine CAS-No. 108-78-1 6,6'-di-tert-butyl-2,2'-methylenedi-p-cresol CAS-No. 119-47-1
Net Weight	0.237 kg
Electromagnetic compatibility	
EMC emitted interference according to IEC 60947-1	class A
EMC immunity according to IEC 60947-1	corresponds to degree of severity 3
conducted interference	
<ul style="list-style-type: none"> due to burst according to IEC 61000-4-4 	2 kV (power ports) / 1 kV (signal ports)
<ul style="list-style-type: none"> due to conductor-earth surge according to IEC 61000-4-5 	2 kV
<ul style="list-style-type: none"> due to conductor-conductor surge according to IEC 61000-4-5 	1 kV
<ul style="list-style-type: none"> due to high-frequency radiation according to IEC 61000-4-6 	10 V
field-based interference according to IEC 61000-4-3	10 V/m
electrostatic discharge according to IEC 61000-4-2	6 kV contact discharge / 8 kV air discharge
conducted HF interference emissions according to CISPR11	corresponds to degree of severity A
field-bound HF interference emission according to CISPR11	corresponds to degree of severity A
Inputs/ Outputs	
product function	
<ul style="list-style-type: none"> parameterizable inputs 	Yes
<ul style="list-style-type: none"> parameterizable outputs 	Yes
number of inputs	4
<ul style="list-style-type: none"> for thermistor connection 	1
number of digital inputs with a common reference potential	4
digital input version	
<ul style="list-style-type: none"> type 1 acc. to IEC 61131 	Yes
input voltage at digital input at DC	
<ul style="list-style-type: none"> rated value 	24 V
number of outputs	2

number of semiconductor outputs	0
number of outputs as contact-affected switching element	2
switching behavior	monostable
number of relay outputs	2
type of relay outputs	Monostable
wire length for digital signals maximum	300 m
wire length for thermistor connection	
• with conductor cross-section = 0.5 mm ² maximum	50 m
• with conductor cross-section = 1.5 mm ² maximum	150 m
• with conductor cross-section = 2.5 mm ² maximum	250 m

Protective and monitoring functions

product function	
• asymmetry detection	Yes
• blocking current evaluation	Yes
• power factor monitoring	No
• ground fault detection	Yes
• ground-fault monitoring	No
• phase failure detection	Yes
• phase sequence recognition	No
• voltage detection	No
• monitoring of number of start operations	Yes
• overvoltage detection	No
• overcurrent detection 1 phase	Yes
• undervoltage detection	No
• undercurrent detection 1 phase	Yes
• active power monitoring	No
product function	
• current detection	Yes
• overload protection	Yes
• evaluation of thermistor motor protection	Yes
total cold resistance number of sensors in series maximum	1.5 kΩ
response value of thermoresistor	3 400 ... 3 800 Ω
• of the short-circuit control	9 Ω
release value of thermoresistor	1 500 ... 1 650 Ω















Motor control functions

product function	
• parameterizable overload relay	Yes
• circuit breaker control	Yes
• direct start	Yes
• reverse starting	Yes
• star-delta circuit	Yes
• star-delta reversing circuit	No
• Dahlander circuit	No
• Dahlander reversing circuit	No
• pole-changing switch circuit	No
• pole-changing switch reversing circuit	No
• slide control	No
• valve control	No

Communication/ Protocol

protocol is supported	
• PROFIBUS DP protocol	Yes
• PROFINET IO protocol	No
• PROFIsafe protocol	No
• Modbus RTU	No
• EtherNet/IP	No
• OPC UA Server	No
• LLDP	No
• Address Resolution Protocol (ARP)	No
• SNMP	No

<ul style="list-style-type: none"> • HTTPS • NTP • Media Redundancy Protocol (MRP) 	No
<ul style="list-style-type: none"> • web server • shared device • at the Ethernet interface Autocrossover • at the Ethernet interface Autonegotiation • at the Ethernet interface Autosensing • is supported Device Level Ring (DLR) • is supported PROFINET system redundancy (S2) • supports PROFinergy measured values • supports PROFinergy shutdown 	No
transfer rate maximum	1.5 Mbit/s
identification & maintenance function <ul style="list-style-type: none"> • I&M0 - device-specific information • I&M1 - higher level designation/location designation • I&M2 - installation date • I&M3 - comment 	Yes
type of electrical connection of the communication interface	Screw-type terminal (1.5 Mbit)
Installation/ mounting/ dimensions	
mounting position	any
fastening method	screw and snap-on mounting
height	100 mm
width	22.5 mm
depth	124.5 mm
required spacing <ul style="list-style-type: none"> • top • bottom • left • right 	40 mm 40 mm 0 mm 0 mm
Connections/ Terminals	
product component removable terminal for auxiliary and control circuit	Yes
type of electrical connection <ul style="list-style-type: none"> • for auxiliary and control circuit 	screw-type terminals
type of connectable conductor cross-sections <ul style="list-style-type: none"> • solid • finely stranded with core end processing • for AWG cables solid 	1x (0.5 ... 2.5 mm ²), 2x (0.5 ... 1.5 mm ²) 1x (0.5 ... 2.5 mm ²), 2x (0.5 ... 1 mm ²) 1x (20 ... 14), 2x (20 ... 16)
tightening torque with screw-type terminals	0.6 ... 0.8 N·m
tightening torque [lbf·in] with screw-type terminals	5.2 ... 7 lbf·in
type of connectable conductor cross-sections for PROFIBUS wire	2x 0.34 mm ² , AWG 22
Ambient conditions	
installation altitude at height above sea level maximum <ul style="list-style-type: none"> • note 	2 000 m Restrictions apply to higher installation altitudes, see: https://support.industry.siemens.com/cs/document/109995153
ambient temperature <ul style="list-style-type: none"> • during operation • during storage • during transport 	-25 ... +60 °C -40 ... +80 °C -40 ... +80 °C
environmental category <ul style="list-style-type: none"> • during operation according to IEC 60721 • during storage according to IEC 60721 • during transport according to IEC 60721 	3K6 (no formation of ice, no condensation, relative humidity 10 ... 95%), 3C3 (no salt mist), 3S2 (sand must not get into the devices), 3M6 1K6 (no condensation, relative humidity 10 ... 95%), 1C2 (no salt mist), 1S2 (sand must not get into the devices), 1M4 2K2, 2C1, 2S1, 2M2
relative humidity <ul style="list-style-type: none"> • during operation 	10 ... 95 %

contact rating of auxiliary contacts according to UL	B300 / R300	
Short-circuit protection		
design of short-circuit protection per output	Fuse links: gG 6 A, quick-response 10 A (IEC 60947-5-1), miniature circuit-breaker C char.: 1.6 A (IEC 60947-5-1) or 6 A (I _K < 500 A)	
Electrical Safety		
touch protection against electrical shock	finger-safe	
ATEX		
certificate of suitability		
<ul style="list-style-type: none"> • according to ATEX directive 2014/34/EU • acc. to Equipment and Protective System Intended for Use in Potentially Explosive Atmospheres Regulations 2016 (S.I. 2016 No.1107) • according to UKCA 	BVS 06 ATEX F001 ITS21UKEX0464, ITS21UKEX0455X ITS21UKEX0464	
Galvanic isolation		
(electrically) protective separation according to IEC 60947-1	All circuits with protective separation (double creepage paths and clearances), the information in the "Protective Separation" test report, No. A0258, must be observed (link see further information)	
design of the electrical isolation	Protective separation in accordance with IEC 60947-1 for all circuits	
<ul style="list-style-type: none"> • note 	Test report No. A0258 must be observed (https://support.industry.siemens.com/cs/document/109748152)	
Control circuit/ Control		
product function soft starter control	Yes	
type of voltage of the control supply voltage	DC	
control supply voltage at DC rated value	24 V	
control supply voltage 1 at DC rated value	24 V	
operating range factor control supply voltage rated value at DC		
<ul style="list-style-type: none"> • initial value • full-scale value 	0.85 1.2	
inrush current peak		
<ul style="list-style-type: none"> • at 24 V 	7.5 A	
duration of inrush current peak		
<ul style="list-style-type: none"> • at 24 V 	2.2 ms	
Approvals Certificates		
Environment	General Product Approval	
Environmental Confirmations     		
General Product Approval	EMV	For use in hazardous locations
     		
For use in hazardous locations	Test Certificates	Maritime application
 Miscellaneous Special Test Certificate Type Test Certificates/Test Report  		
Maritime application	other	Industrial Communication

Further information

Information on the packaging

<https://support.industry.siemens.com/cs/ww/en/view/109813875>

Information for data generation and storage

<https://support.industry.siemens.com/cs/ww/en/view/109995012>

Information- and Downloadcenter (Catalogs, Brochures,...)

<https://www.siemens.com/ic10>

Industry Mall (Online ordering system)

<https://mall.industry.siemens.com/mall/en/en/Catalog/product?mlfb=3UF7020-1AB01-0>

Cax online generator

<https://support.automation.siemens.com/WW/CAXorder/default.aspx?lang=en&mlfb=3UF7020-1AB01-0>

Service&Support (Manuals, Certificates, Characteristics, FAQs,...)

<https://support.industry.siemens.com/cs/ww/en/ps/3UF7020-1AB01-0>

Image database (product images, 2D dimension drawings, 3D models, device circuit diagrams, EPLAN macros, ...)

https://www.automation.siemens.com/bilddb/cax_de.aspx?mlfb=3UF7020-1AB01-0&lang=en

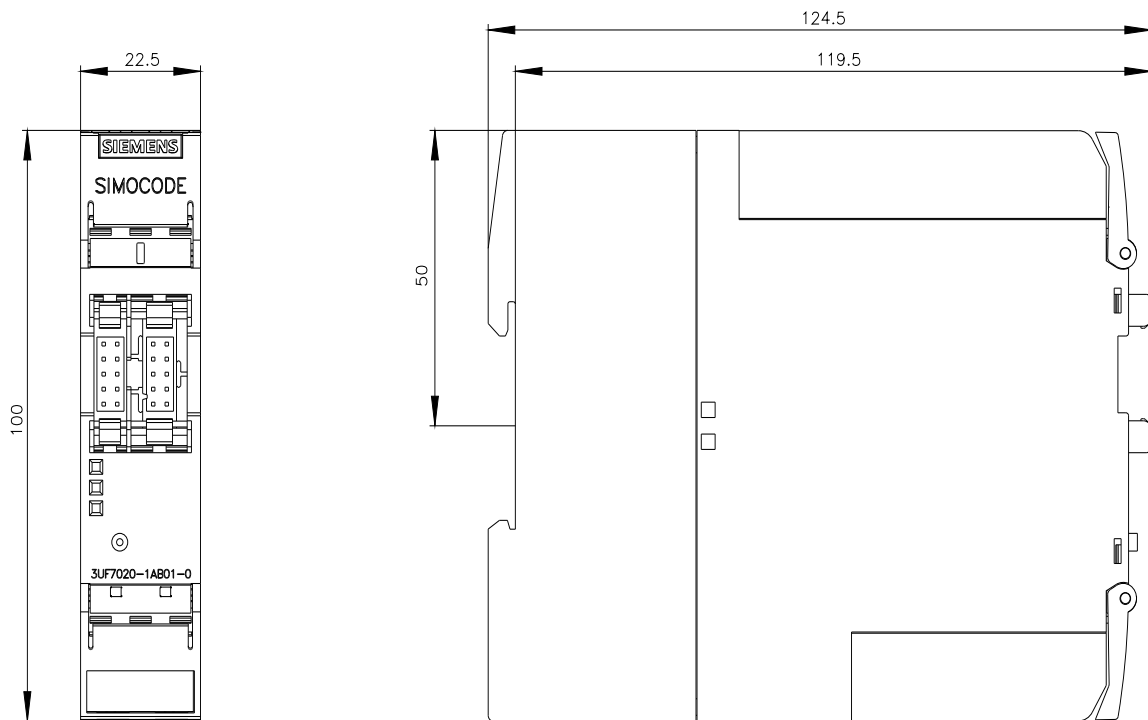

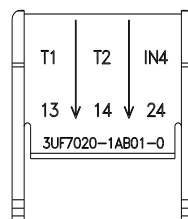
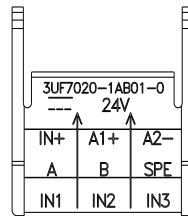
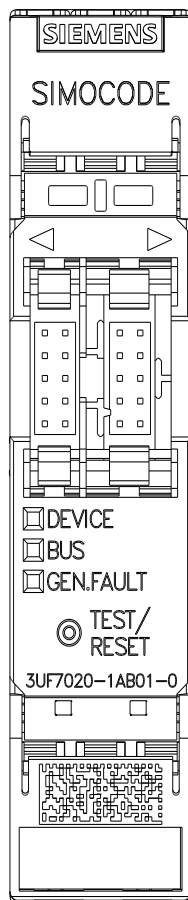
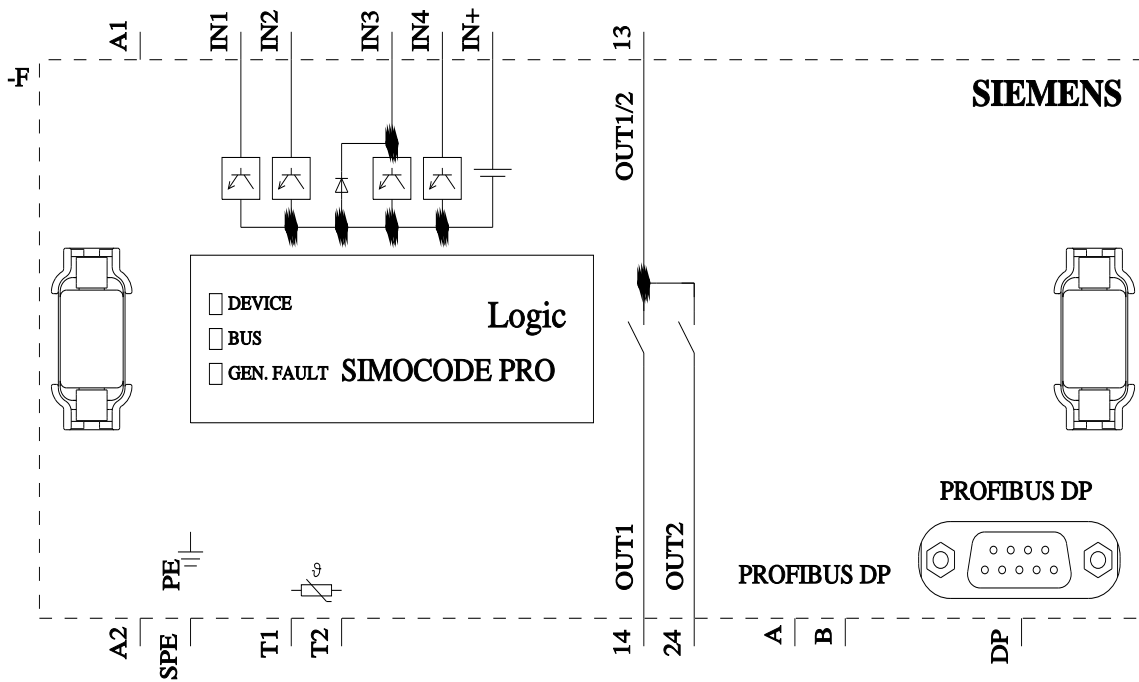

last modified:

4/4/2026