



Circuit breaker size S00 for starter combination Rated current 3.2 A N release 42 A Spring-type terminal Standard switching capacity

product brand name	SIRIUS
product designation	Circuit breaker
design of the product	For starter combinations
product type designation	3RV2
<b>General technical data</b>	
Product equipment of circuit breaker for motor protection complete unit with protection device	Yes
size of the circuit-breaker	S00
size of contactor can be combined company-specific	S00, S0
product function disconnecter functionality	Yes
product extension auxiliary switch	Yes
power loss [W] for rated value of the current	
• at AC in hot operating state	7.25 W
• at AC in hot operating state per pole	2.4 W
type of calculation of power loss current-dependent	quadratic
insulation voltage with degree of pollution 3 at AC rated value	690 V
surge voltage resistance rated value	6 kV
maximum permissible voltage for protective separation	
• in networks with ungrounded star point between main and auxiliary circuit	400 V
• in networks with grounded star point between main and auxiliary circuit	400 V
protection class IP	
• on the front according to IEC 60529	IP20
• on the front	IP20
• of the terminal	IP20
shock resistance according to IEC 60068-2-27	25g / 11 ms
mechanical service life (operating cycles)	
• of the main contacts typical	100 000
• of auxiliary contacts typical	100 000
electrical endurance (operating cycles) typical	100 000
reference code according to IEC 81346-2	Q
continuous current rated value	3.2 A
Substance Prohibitance (day/month/year)	10/01/2009
SVHC substance name	Lead CAS-No. 7439-92-1
Net Weight	0.366 g
<b>Ambient conditions</b>	

installation altitude at height above sea level maximum	2 000 m
<b>ambient temperature</b>	
• during operation	-20 ... +60 °C
• during storage	-50 ... +80 °C
• during transport	-50 ... +80 °C
relative humidity during operation	10 ... 95 %
<b>Main circuit</b>	
<b>number of poles for main current circuit</b>	3
<b>type of voltage for main current circuit</b>	AC
<b>operating voltage</b>	
• rated value	690 V
• rated value	20 ... 690 V
• at AC-3 rated value maximum	690 V
• at AC-3e rated value maximum	690 V
<b>operating frequency rated value</b>	50 ... 60 Hz
<b>operational current rated value</b>	3.2 A
<b>operational current</b>	
• at AC-3 at 400 V rated value	3.2 A
• at AC-3e at 400 V rated value	3.2 A
<b>operating power</b>	
• at AC-3	
— at 230 V rated value	0.6 kW
— at 400 V rated value	1.1 kW
— at 500 V rated value	1.5 kW
— at 690 V rated value	2.2 kW
• at AC-3e	
— at 230 V rated value	0.6 kW
— at 400 V rated value	1.1 kW
— at 500 V rated value	1.5 kW
— at 690 V rated value	2.2 kW
<b>operating frequency</b>	
• at AC-3 maximum	15 1/h
• at AC-3e maximum	15 1/h
<b>Auxiliary circuit</b>	
<b>type of voltage for auxiliary and control circuit</b>	AC/DC
<b>number of NC contacts for auxiliary contacts</b>	0
<b>number of NO contacts for auxiliary contacts</b>	0
number of CO contacts for auxiliary contacts	0
<b>Protective and monitoring functions</b>	
<b>product function</b>	
• ground fault detection	No
• phase failure detection	No
<b>protection function thermal overload protection (ANSI 49)</b>	No
<b>maximum short-circuit current breaking capacity (I<sub>cu</sub>)</b>	
• at AC at 240 V rated value	100 kA
• at AC at 400 V rated value	100 kA
• at AC at 500 V rated value	100 kA
• at AC at 690 V rated value	10 kA
<b>operating short-circuit current breaking capacity (I<sub>cs</sub>) at AC</b>	
• at 240 V rated value	100 kA
• at 400 V rated value	100 kA
• at 500 V rated value	100 kA
• at 690 V rated value	10 kA
response value current of instantaneous short-circuit trip unit	42 A
<b>UL/CSA ratings</b>	
<b>full-load current (FLA) for 3-phase AC motor</b>	
• at 480 V rated value	3.2 A
• at 600 V rated value	3.2 A
<b>yielded mechanical performance [hp]</b>	

<ul style="list-style-type: none"> <li>● for single-phase AC motor <ul style="list-style-type: none"> <li>— at 110/120 V rated value</li> <li>— at 230 V rated value</li> </ul> </li> <li>● for 3-phase AC motor <ul style="list-style-type: none"> <li>— at 200/208 V rated value</li> <li>— at 220/230 V rated value</li> <li>— at 460/480 V rated value</li> <li>— at 575/600 V rated value</li> </ul> </li> </ul>	0.1 hp 0.25 hp  0.5 hp 0.75 hp 2 hp 2 hp
<b>UL File Number (CCN)</b>	E47705 (NLRV, NLRV7)
<b>Short-circuit protection</b>	
<b>product function short circuit protection</b>	Yes
<b>design of the short-circuit trip</b>	magnetic
<b>design of the fuse link for IT network for short-circuit protection of the main circuit</b>	
<ul style="list-style-type: none"> <li>● at 400 V</li> <li>● at 500 V</li> <li>● at 690 V</li> </ul>	gL/gG 25 A gL/gG 32 A gL/gG 25 A
<b>Installation/ mounting/ dimensions</b>	
<b>mounting position</b>	any
<b>fastening method</b>	screw and snap-on mounting onto 35 mm DIN rail according to DIN EN 60715
<b>Mounting method of circuit breaker for Transformer protection, Generator protection and system protection optional standard bar mounting</b>	Yes
<b>height</b>	106 mm
<b>width</b>	45 mm
<b>depth</b>	97 mm
<b>required spacing</b>	
<ul style="list-style-type: none"> <li>● with side-by-side mounting <ul style="list-style-type: none"> <li>— forwards</li> <li>— backwards</li> <li>— upwards</li> <li>— downwards</li> <li>— at the side</li> </ul> </li> <li>● for grounded parts <ul style="list-style-type: none"> <li>— forwards</li> <li>— backwards</li> <li>— upwards</li> <li>— at the side</li> <li>— downwards</li> </ul> </li> <li>● for live parts <ul style="list-style-type: none"> <li>— forwards</li> <li>— backwards</li> <li>— upwards</li> <li>— downwards</li> <li>— at the side</li> </ul> </li> <li>● for grounded parts at 400 V <ul style="list-style-type: none"> <li>— downwards</li> <li>— upwards</li> <li>— at the side</li> </ul> </li> <li>● for live parts at 400 V <ul style="list-style-type: none"> <li>— downwards</li> <li>— upwards</li> <li>— at the side</li> </ul> </li> <li>● for grounded parts at 500 V <ul style="list-style-type: none"> <li>— downwards</li> <li>— upwards</li> <li>— at the side</li> </ul> </li> <li>● for live parts at 500 V <ul style="list-style-type: none"> <li>— downwards</li> <li>— upwards</li> </ul> </li> </ul>	0 mm 0 mm 50 mm 50 mm 0 mm  0 mm 0 mm 50 mm 30 mm 50 mm  0 mm 0 mm 50 mm 50 mm 30 mm  30 mm 30 mm 9 mm  30 mm 30 mm 9 mm  30 mm 30 mm 9 mm  30 mm 30 mm

— at the side	9 mm
● for grounded parts at 690 V	
— downwards	50 mm
— upwards	50 mm
— backwards	0 mm
— at the side	30 mm
— forwards	0 mm
● for live parts at 690 V	
— downwards	50 mm
— upwards	50 mm
— backwards	0 mm
— at the side	30 mm
— forwards	0 mm

#### Connections/ Terminals

<b>product component removable terminal for auxiliary and control circuit</b>	No
<b>type of electrical connection</b>	
● for main current circuit	spring-loaded terminals
<b>arrangement of electrical connectors for main current circuit</b>	Top and bottom
<b>type of connectable conductor cross-sections</b>	
● for main contacts	
— solid or stranded	2x (0,5 ... 4 mm <sup>2</sup> )
— finely stranded with core end processing	2x (0,5 ... 2,5 mm <sup>2</sup> )
— finely stranded without core end processing	2x (0,5 ... 2,5 mm <sup>2</sup> )
● for AWG cables for main contacts	2x (20 ... 12)
<b>connectable conductor cross-section for main contacts</b>	
● solid or stranded	0,5 ... 4 mm <sup>2</sup>
● finely stranded with core end processing	0,5 ... 2,5 mm <sup>2</sup>
● finely stranded without core end processing	0,5 ... 2,5 mm <sup>2</sup>
<b>AWG number as coded connectable conductor cross section for main contacts</b>	20 ... 12
<b>design of screwdriver shaft</b>	Diameter 3 mm
<b>size of the screwdriver tip</b>	3,0 x 0,5 mm















#### Safety related data

product function suitable for safety function	Yes
<b>suitability for use</b>	
● safety-related switching on	No
● safety-related switching OFF	Yes
<b>service life maximum</b>	10 a
<b>test wear-related service life necessary</b>	Yes
<b>proportion of dangerous failures</b>	
● with low demand rate according to SN 31920	40 %
● with high demand rate according to SN 31920	50 %
<b>B10 value with high demand rate according to SN 31920</b>	5 000
<b>failure rate [FIT] with low demand rate according to SN 31920</b>	50 FIT
ISO 13849	
<b>device type according to ISO 13849-1</b>	3
<b>overdimensioning according to ISO 13849-2 necessary</b>	Yes
IEC 61508	
<b>safety device type according to IEC 61508-2</b>	Type A
<b>T1 value</b>	
● for proof test interval or service life according to IEC 61508	10 a
Electrical Safety	
<b>protection class IP on the front according to IEC 60529</b>	IP20
<b>touch protection on the front according to IEC 60529</b>	finger-safe, for vertical contact from the front

#### Display

display version for switching status	Handle
--------------------------------------	--------

## Approvals Certificates

Environment		General Product Approval			
<a href="#">Environmental Confirmations</a>					
General Product Approval		Test Certificates		Maritime application	
			<a href="#">Special Test Certificate</a>	<a href="#">Type Test Certificates/Test Report</a>	
Maritime application				other	
					<a href="#">Miscellaneous</a>
other		Railway			
<a href="#">Confirmation</a>	<a href="#">Miscellaneous</a>		<a href="#">Confirmation</a>	<a href="#">Special Test Certificate</a>	

## Further information

### Information on the packaging

<https://support.industry.siemens.com/cs/ww/en/view/109813875>

### Information for data generation and storage

<https://support.industry.siemens.com/cs/ww/en/view/109995012>

### Information- and Downloadcenter (Catalogs, Brochures,...)

<https://www.siemens.com/ic10>

### Industry Mall (Online ordering system)

<https://mall.industry.siemens.com/mall/en/en/Catalog/product?mlfb=3RV2311-1DC20>

### Service&Support (Manuals, Certificates, Characteristics, FAQs,...)

<https://support.industry.siemens.com/cs/ww/en/ps/3RV2311-1DC20>

### Image database (product images, 2D dimension drawings, 3D models, device circuit diagrams, EPLAN macros, ...)

[https://www.automation.siemens.com/bilddb/cax\\_de.aspx?mlfb=3RV2311-1DC20&lang=en](https://www.automation.siemens.com/bilddb/cax_de.aspx?mlfb=3RV2311-1DC20&lang=en)

### Cax online generator

<https://support.automation.siemens.com/WW/CAXorder/default.aspx?lang=en&mlfb=3RV2311-1DC20>

### Characteristic curves

[https://curves.simaris.siemens.com/curves/<mmp\\_prod\\_noCOMP="HAUPT"></mmp\\_prod\\_no>](https://curves.simaris.siemens.com/curves/<mmp_prod_noCOMP=)

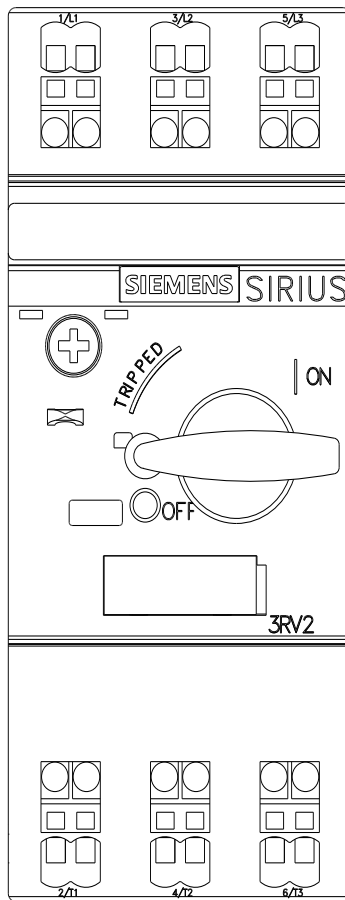
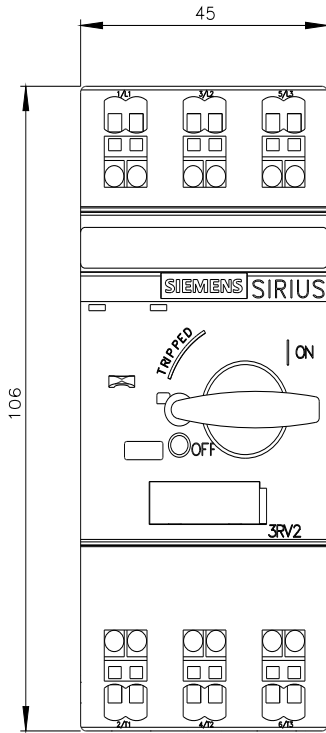



last modified:

5/5/2026 