





NEOZED, fuse base, D02, 3-pole, 63 A, Un AC: 400 V, Un DC: 250 V incoming terminal: saddle terminal outgoing terminal: saddle terminal



Model	
product brand name	SETRON
product designation	NEOZED fuse bases
design of the product	NEOZED fuse base installation
General technical data	
number of poles	3
size of fuse system according to EN 60269-1	D02
Supply voltage	
operating voltage rated value	400 V
Dissipation	
power loss [W] for rated value of the current at AC in hot operating state per pole	3 W
Main circuit	
operational current rated value	63 A
Product details	
product component cover	Yes
Mechanical Design	
height	59 mm
width	80.8 mm
depth	41 mm
fastening method	DIN rail
Net Weight	
material of D fuse base	porcelain
Approvals Certificates	
Environment	General Product Approval
Environmental Conformations	Environmental Conformations
	
	Confirmation
	
General Product Approval	other
	Confirmation
	

Further information

Information on the packaging

<https://support.industry.siemens.com/cs/ww/en/view/109813875>

Information for data generation and storage

<https://support.industry.siemens.com/cs/ww/en/view/109995012>

Information- and Downloadcenter (Catalogs, Brochures,...)

<https://www.siemens.com/lowvoltage/catalogs>

Industry Mall (Online ordering system)

<https://mall.industry.siemens.com/mall/en/en/Catalog/product?mlfb=5SG5653>

Service&Support (Manuals, Certificates, Characteristics, FAQs,...)

<https://support.industry.siemens.com/cs/ww/en/ps/5SG5653>

Image database (product images, 2D dimension drawings, 3D models, device circuit diagrams, ...)

https://www.automation.siemens.com/bilddb/cax_en.aspx?mlfb=5SG5653

CAX-Online-Generator

<https://www.siemens.com/cax>

Tender specifications

<https://www.siemens.com/specifications>

Characteristic curves

[https://curves.simaris.siemens.com/curves/<mmp_prod_noCOMP="HAUPT"></mmp_prod_no>](https://curves.simaris.siemens.com/curves/<mmp_prod_noCOMP=)

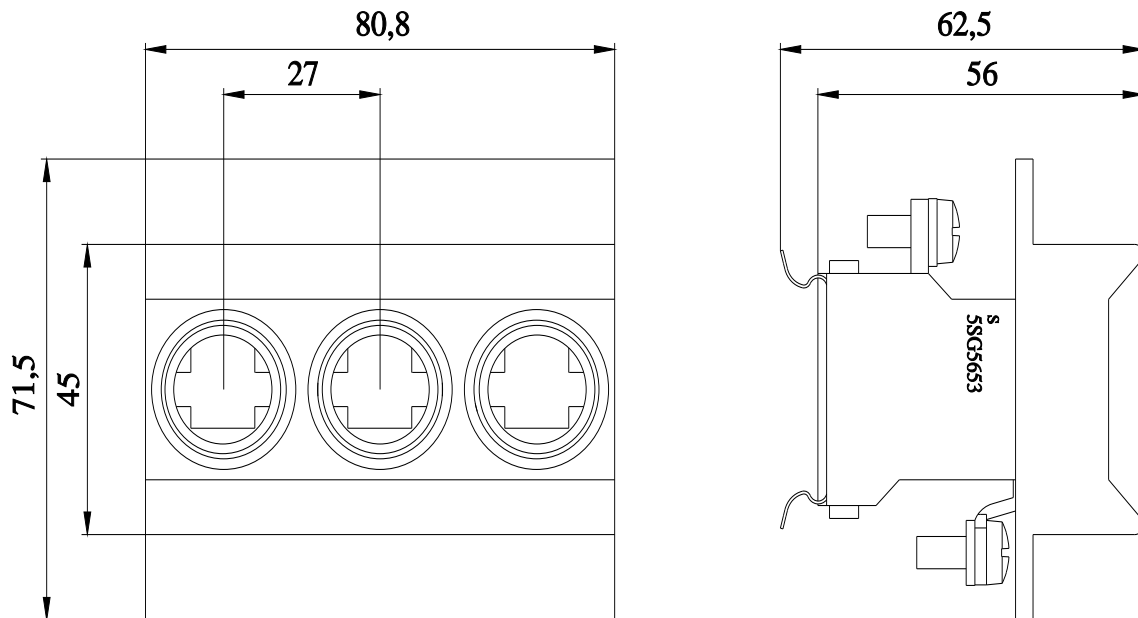

-F

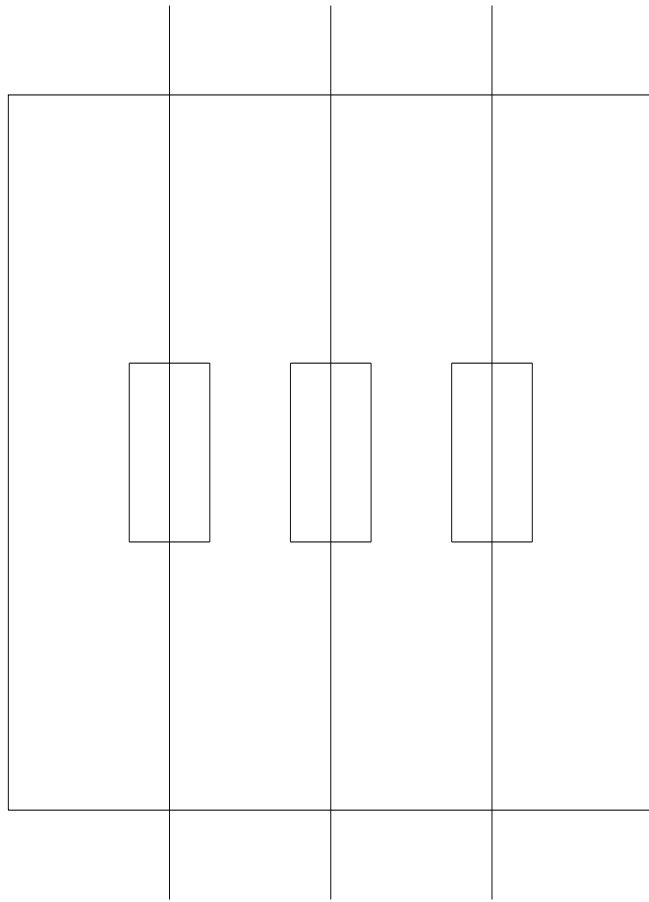

last modified:

4/6/2026 

