

NEOZED, fuse base, D01, 3-pole, 16 A, Un AC: 400 V, Un DC: 250 V without LED signal detector with frame terminal



Figure similar

Model	
product brand name	SENTRON
product designation	NEOZED fuse bases
design of the product	NEOZED fuse base installation
General technical data	
number of poles	3
size of fuse system according to EN 60269-1	D01
Supply voltage	
operating voltage rated value	400 V
Dissipation	
power loss [W] for rated value of the current at AC in hot operating state per pole	0.6 W
Main circuit	
operational current rated value	16 A
Product details	
product component cover	Yes
Mechanical Design	
height	67 mm
width	81 mm
depth	55 mm
fastening method	DIN rail
Net Weight	
material of D fuse base	plastic
Approvals Certificates	
Environment	General Product Approval

[Environmental Con-
firmations](#)

[Environmental Con-
firmations](#)



[Confirmation](#)



General Product Ap-
proval

other



[Confirmation](#)



Further information

Information on the packaging

<https://support.industry.siemens.com/cs/ww/en/view/109813875>

Information for data generation and storage

<https://support.industry.siemens.com/cs/ww/en/view/109995012>

Information- and Downloadcenter (Catalogs, Brochures,...)

<https://www.siemens.com/lowvoltage/catalogs>

Industry Mall (Online ordering system)

<https://mall.industry.siemens.com/mall/en/en/Catalog/product?mlfb=5SG5302>

Service&Support (Manuals, Certificates, Characteristics, FAQs,...)

<https://support.industry.siemens.com/cs/ww/en/ps/5SG5302>

Image database (product images, 2D dimension drawings, 3D models, device circuit diagrams, ...)

https://www.automation.siemens.com/bilddb/cax_en.aspx?mlfb=5SG5302

CAX-Online-Generator

<https://www.siemens.com/cax>

Tender specifications

<https://www.siemens.com/specifications>

Characteristic curves

[https://curves.simaris.siemens.com/curves/<mmp_prod_noCOMP="HAUPT"></mmp_prod_no>](https://curves.simaris.siemens.com/curves/<mmp_prod_noCOMP=)

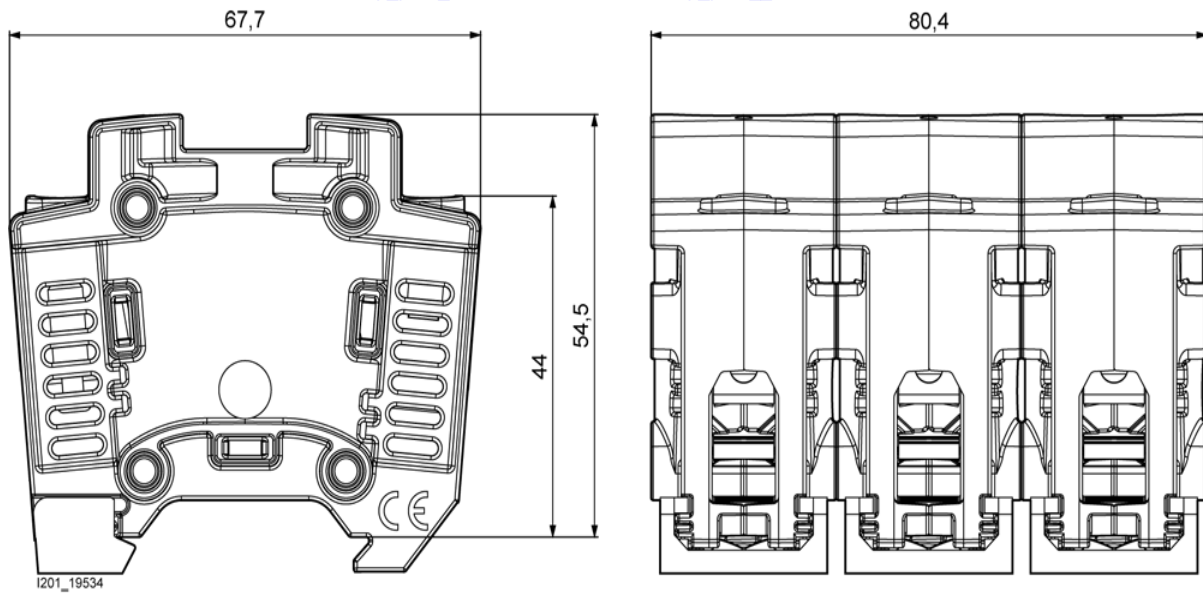

last modified:

4/6/2026

