









Handle unit with EFM25, for Size NH2, accessory for fuse switch disconnecter 3NP1

Model	
product brand name	SENTRON
product designation	Fuse carrier with EFM25
design of the product	accessories for 3NP1 fuse switch disconnectors
suitability for use	spare part, for 3NP1, 3-pole, NH2
Accessories	
accessories	for size NH2
Mechanical Design	
Net Weight	3 kg
Approvals Certificates	
Environment	General Product Approval
Environmental Confirmations	Environmental Confirmations
	Miscellaneous
	
	
General Product Approval	Test Certificates
	Maritime application
Type Test Certificates/Test Report	
	Confirmation
	

Further information

Information on the packaging
<https://support.industry.siemens.com/cs/ww/en/view/109813875>
 Information for data generation and storage
<https://support.industry.siemens.com/cs/ww/en/view/109995012>
 Information- and Downloadcenter (Catalogs, Brochures,...)
<https://www.siemens.com/lowvoltage/catalogs>
 Industry Mall (Online ordering system)
<https://mall.industry.siemens.com/mall/en/en/Catalog/product?mlfb=3NP1953-1GB50>
 Service&Support (Manuals, Certificates, Characteristics, FAQs,...)
<https://support.industry.siemens.com/cs/ww/en/ps/3NP1953-1GB50>
 Image database (product images, 2D dimension drawings, 3D models, device circuit diagrams, ...)
https://www.automation.siemens.com/bilddb/cax_en.aspx?mlfb=3NP1953-1GB50
 CAx-Online-Generator
<https://www.siemens.com/cax>
 Tender specifications
<https://www.siemens.com/specifications>
 Characteristic curves

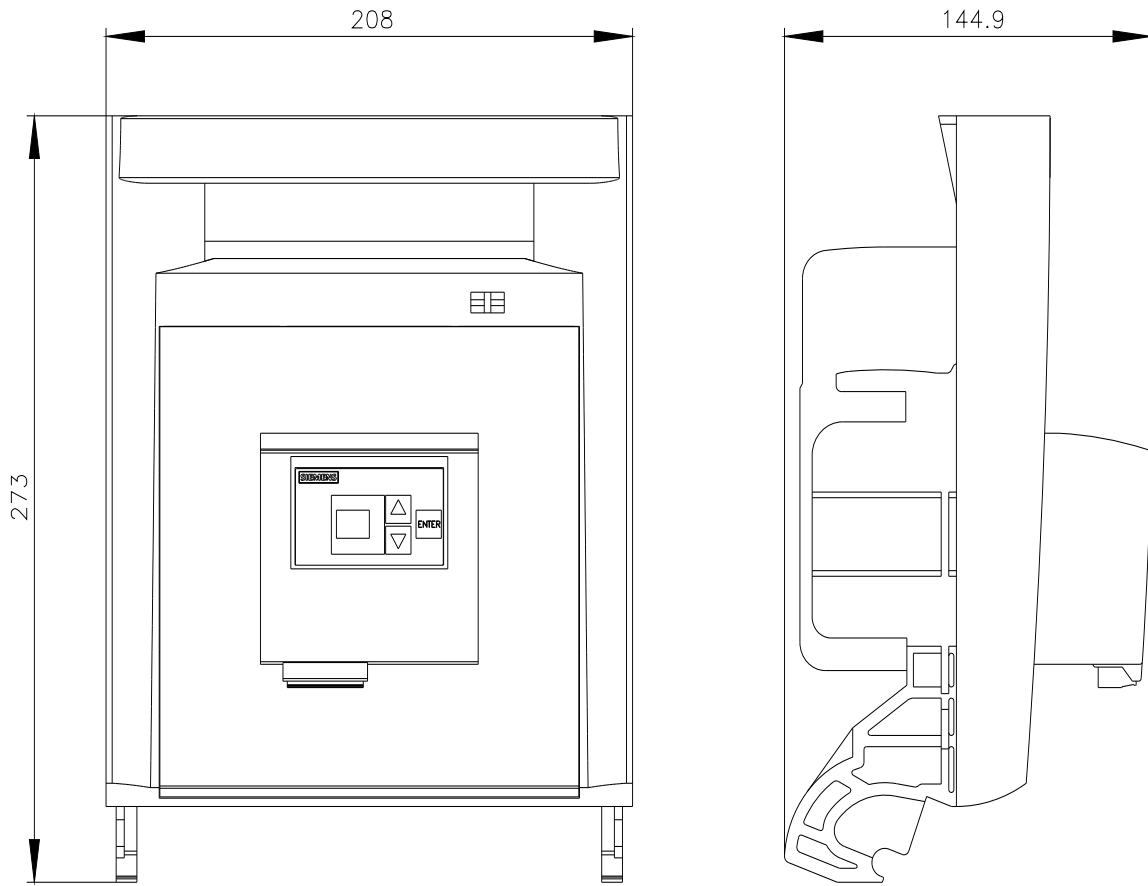

last modified:

4/12/2025 

