

Siemens  
EcoTech



AFDD-MCB-Combination 230V, 6kA, 1+N, C, 25A Compact (1MW)



Figure similar

Model	
product brand name	SENTRON
product designation	AFDD/MCB
design of the product	Compact unit
General technical data	
number of poles	2
design of pole	1P+N
tripping characteristic class	C
size of installation devices according to DIN 43880	1
touch protection against electrical shock according to EN 50274	finger and back-of-hand safe
mechanical service life (operating cycles) typical	10 000
switching function short-term delayed	No
overvoltage category	3
degree of pollution	2
type of voltage of the operating voltage	AC
Supply voltage	
supply voltage	
• at AC	230 V
value range of the supply voltage frequency	50Hz
Protection class	
protection class IP	IP20, with connected protective device and conductors
Breaking Capacity	
switching capacity current	
• according to EN 60898-1 rated value	6 000 A
• according to IEC 60947-2 rated value	6 000 A
energy limitation class	3
Dissipation	
power loss [W] for rated value of the current at AC in hot operating state per pole	2.22 W
Product details	
product feature halogen-free	Yes
product feature silicon-free	Yes
product extension installable supplementary devices	Yes
Connections	

<b>connectable conductor cross-section solid</b>	
• minimum	0.75 mm <sup>2</sup>
• maximum	16 mm <sup>2</sup>
<b>connectable conductor cross-section stranded</b>	
• minimum	0.75 mm <sup>2</sup>
• maximum	16 mm <sup>2</sup>
<b>connectable conductor cross-section finely stranded with core end processing</b>	
• minimum	0.75 mm <sup>2</sup>
• maximum	10 mm <sup>2</sup>
<b>tightening torque with screw-type terminals</b>	
• minimum	1.2 N·m
• maximum	2 N·m
<b>position of power supply cord</b>	any

#### Mechanical Design

<b>height</b>	90 mm
<b>width</b>	18 mm
<b>depth</b>	68.5 mm
<b>installation depth</b>	70 mm
<b>number of modular width units</b>	1
<b>fastening method</b>	DIN rail
<b>mounting position</b>	any
<b>Net Weight</b>	136 g

#### Environmental conditions

<b>ambient temperature during operation</b>	
• minimum	-25 °C
• maximum	45 °C
<b>ambient temperature during storage</b>	
• minimum	-40 °C
• maximum	75 °C
<b>ambient temperature with relative humidity 95%</b>	55 °C
<b>number of test cycles for environmental testing according to IEC 60068-2-30</b>	28

#### Certificates

<b>reference code according to IEC 81346-2</b>	F
--	---

#### Approvals Certificates

<b>Environment</b>	<b>General Product Approval</b>
--------------------	---------------------------------

[Environmental Conformations](#)



[Environmental Conformations](#)



<b>General Product Approval</b>	<b>Test Certificates</b>	<b>other</b>
---------------------------------	--------------------------	--------------

[Confirmation](#)



[Miscellaneous](#)



[Confirmation](#)

#### Further information

**Information on the packaging**

<https://support.industry.siemens.com/cs/ww/en/view/109813875>

**Information for data generation and storage**

<https://support.industry.siemens.com/cs/ww/en/view/109995012>

**Information- and Downloadcenter (Catalogs, Brochures,...)**

<https://www.siemens.com/lowvoltage/catalogs>

**Industry Mall (Online ordering system)**

<https://mall.industry.siemens.com/mall/en/en/Catalog/product?mifb=5SV6016-7KK25>

**Service&Support (Manuals, Certificates, Characteristics, FAQs,...)**

<https://support.industry.siemens.com/cs/ww/en/ps/5SV6016-7KK25>

**Image database (product images, 2D dimension drawings, 3D models, device circuit diagrams, ...)**

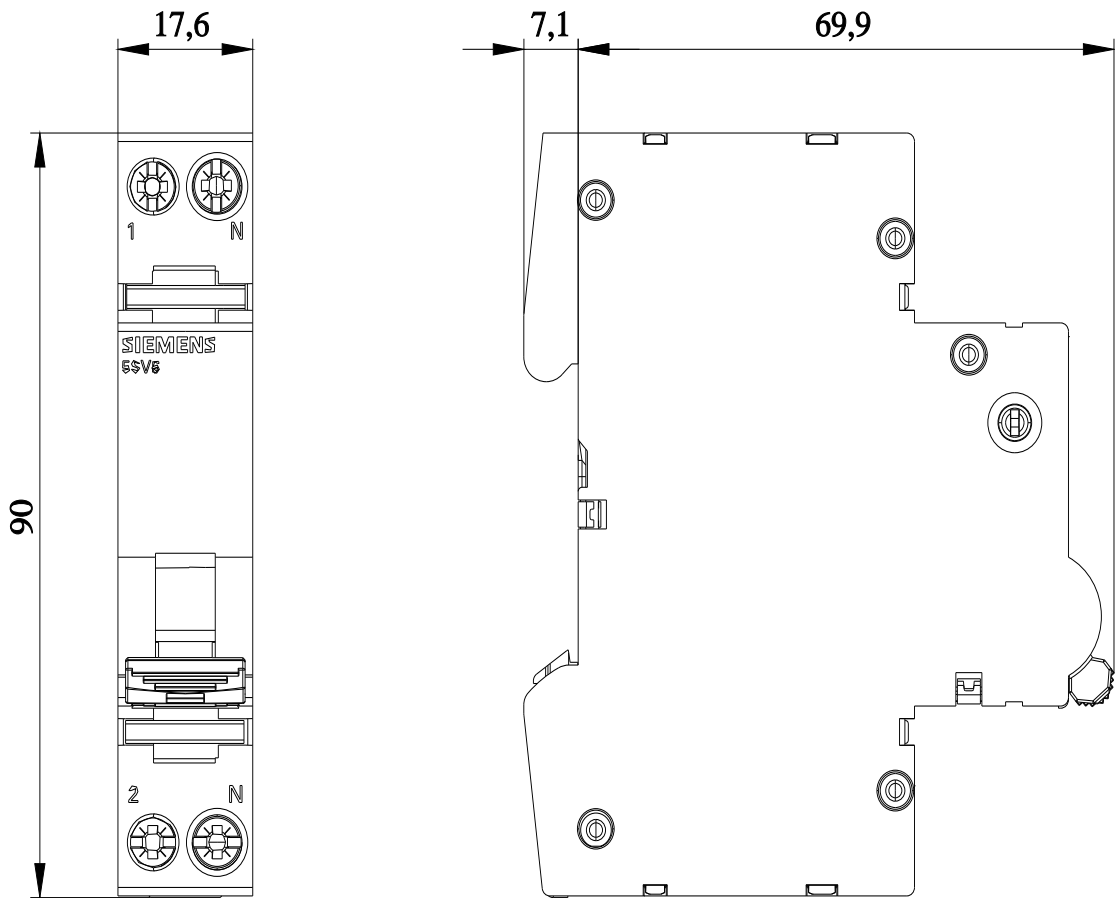

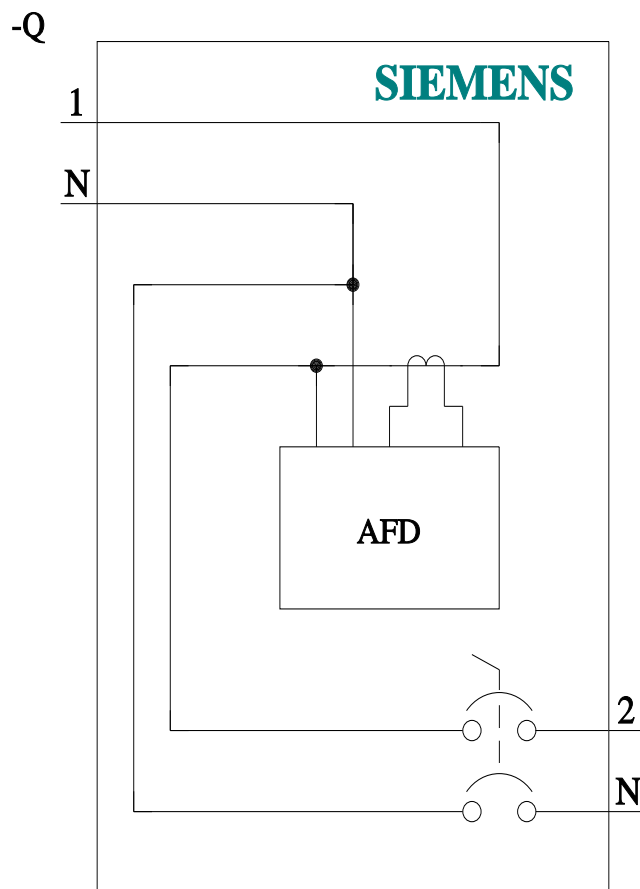

last modified:

7/19/2025

