

Field Stop Trench IGBT

40 A, 650 V

AFGHL40T65SQ

Using the novel field stop 4th generation high speed IGBT technology. AFGHL40T65SQ which is AEC Q101 qualified offers the optimum performance for both hard and soft switching topology in automotive application. It is a stand-alone IGBT.

Features

- AEC-Q101 Qualified
- Maximum Junction Temperature: $T_J = 175^\circ\text{C}$
- Positive Temperature Co-efficient for Easy Parallel Operating
- High Current Capability
- Low Saturation Voltage: $V_{CE(Sat)} = 1.6\text{ V (Typ.) @ } I_C = 40\text{ A}$
- 100% of the Parts are Tested for I_{LM} (Note 2)
- Fast Switching
- Tight Parameter Distribution
- RoHS Compliant

Typical Applications

- Automotive HEV-EV Onboard Chargers
- Automotive HEV-EV DC-DC Converters
- Totem Pole Bridgeless PFC
- PTC

MAXIMUM RATINGS

| Rating | Symbol | Value | Unit |
|--|----------------|---|------------------|
| Collector-to-Emitter Voltage | V_{CES} | 650 | V |
| Gate-to-Emitter Voltage Transient Gate-to-Emitter Voltage | V_{GES} | ± 20 ± 30 | V |
| Collector Current (Note 1) | I_C | 80 40 | A |
| | | @ $T_C = 25^\circ\text{C}$ @ $T_C = 100^\circ\text{C}$ | |
| Pulsed Collector Current (Note 2) | I_{LM} | 160 | A |
| Pulsed Collector Current (Note 3) | I_{CM} | 160 | A |
| Maximum Power Dissipation | P_D | 239 119 | W |
| | | @ $T_C = 25^\circ\text{C}$ @ $T_C = 100^\circ\text{C}$ | |
| Operating Junction / Storage Temperature Range | T_J, T_{STG} | -55 to +175 | $^\circ\text{C}$ |
| Maximum Lead Temp. for Soldering Purposes, 1/8" from case for 5 seconds | T_L | 300 | $^\circ\text{C}$ |

Stresses exceeding those listed in the Maximum Ratings table may damage the device. If any of these limits are exceeded, device functionality should not be assumed, damage may occur and reliability may be affected.

1. Value limit by bond wire
2. $V_{CC} = 400\text{ V}$, $V_{GE} = 15\text{ V}$, $I_C = 160\text{ A}$, $R_G = 15\ \Omega$, Inductive Load
3. Repetitive Rating: pulse width limited by max. Junction temperature



ON Semiconductor®

www.onsemi.com

40 A, 650 V
 $V_{CESat} = 1.6\text{ V}$

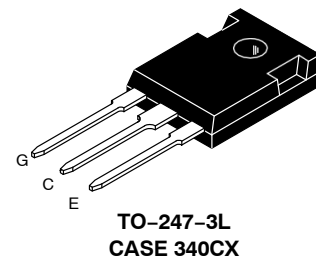
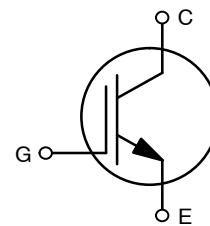

MARKING DIAGRAM

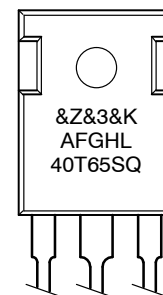

&Z = Assembly Plant Code
&3 = 3-Digit Date Code
&K = 2-Digit Lot Traceability Code
AFGHL40T65SQ = Specific Device Code

ORDERING INFORMATION

| Device | Package | Shipping |
|--------------|-----------|-----------------|
| AFGHL40T65SQ | TO-247-3L | 30 Units / Rail |

AFGHL40T65SQ

THERMAL CHARACTERISTICS

| Rating | Symbol | Value | Unit |
|---|-----------------|-------|------|
| Thermal resistance junction-to-case, for IGBT | $R_{\theta JC}$ | 0.63 | °C/W |
| Thermal resistance junction-to-ambient | $R_{\theta JA}$ | 40 | °C/W |

ELECTRICAL CHARACTERISTICS ($T_J = 25^\circ\text{C}$ unless otherwise noted)

| Parameter | Test Conditions | Symbol | Min | Typ | Max | Unit |
|-----------|-----------------|--------|-----|-----|-----|------|
|-----------|-----------------|--------|-----|-----|-----|------|

OFF CHARACTERISTICS

| | | | | | | |
|---|---|--------------------------------------|-----|-----|------|------|
| Collector-emitter breakdown voltage, gate-emitter short-circuited | $V_{GE} = 0\text{ V},$ $I_C = 1\text{ mA}$ | BV_{CES} | 650 | - | - | V |
| Temperature Coefficient of Breakdown Voltage | $V_{GE} = 0\text{ V},$ $I_C = 1\text{ mA}$ | $\frac{\Delta BV_{CES}}{\Delta T_J}$ | - | 0.6 | - | V/°C |
| Collector-emitter cut-off current, gate-emitter short-circuited | $V_{GE} = 0\text{ V},$ $V_{CE} = 650\text{ V}$ | I_{CES} | - | - | 250 | μA |
| Gate leakage current, collector-emitter short-circuited | $V_{GE} = 20\text{ V},$ $V_{CE} = 0\text{ V}$ | I_{GES} | - | - | ±400 | nA |

ON CHARACTERISTICS

| | | | | | | |
|--------------------------------------|---|---------------|-----|------|-----|---|
| Gate-emitter threshold voltage | $V_{GE} = V_{CE}, I_C = 40\text{ mA}$ | $V_{GE(th)}$ | 3.4 | 4.9 | 6.4 | V |
| Collector-emitter saturation voltage | $V_{GE} = 15\text{ V}, I_C = 40\text{ A}$ $V_{GE} = 15\text{ V}, I_C = 40\text{ A}, T_J = 175^\circ\text{C}$ | $V_{CE(sat)}$ | - | 1.6 | 2.1 | V |
| | | | - | 1.95 | - | |

DYNAMIC CHARACTERISTICS

| | | | | | | |
|------------------------------|--|-----------|---|------|---|----|
| Input capacitance | $V_{CE} = 30\text{ V},$ $V_{GE} = 0\text{ V},$ $f = 1\text{ MHz}$ | C_{ies} | - | 2312 | - | pF |
| Output capacitance | | C_{oes} | - | 30 | - | |
| Reverse transfer capacitance | | C_{res} | - | 8 | - | |
| Gate charge total | $V_{CE} = 400\text{ V},$ $I_C = 40\text{ A},$ $V_{GE} = 15\text{ V}$ | Q_g | - | 68 | - | nC |
| Gate-to-emitter charge | | Q_{ge} | - | 13 | - | |
| Gate-to-collector charge | | Q_{gc} | - | 16 | - | |

SWITCHING CHARACTERISTICS, INDUCTIVE LOAD

| | | | | | | |
|-------------------------|---|--------------|---|------|---|----|
| Turn-on delay time | $T_C = 25^\circ\text{C},$ $V_{CC} = 400\text{ V},$ $I_C = 20\text{ A},$ $R_G = 6\ \Omega,$ $V_{GE} = 15\text{ V},$ Inductive Load, FWD: AFGHL40T65SQD | $t_{d(on)}$ | - | 15 | - | ns |
| Rise time | | t_r | - | 10 | - | |
| Turn-off delay time | | $t_{d(off)}$ | - | 70 | - | |
| Fall time | | t_f | - | 3 | - | |
| Turn-on switching loss | | E_{on} | - | 0.25 | - | mJ |
| Turn-off switching loss | | E_{off} | - | 0.09 | - | |
| Total switching loss | | E_{ts} | - | 0.34 | - | |
| Turn-on delay time | $T_C = 25^\circ\text{C},$ $V_{CC} = 400\text{ V},$ $I_C = 40\text{ A},$ $R_G = 6\ \Omega,$ $V_{GE} = 15\text{ V},$ Inductive Load, FWD: AFGHL40T65SQD | $t_{d(on)}$ | - | 17 | - | ns |
| Rise time | | t_r | - | 22 | - | |
| Turn-off delay time | | $t_{d(off)}$ | - | 67 | - | |
| Fall time | | t_f | - | 31 | - | |
| Turn-on switching loss | | E_{on} | - | 0.75 | - | mJ |
| Turn-off switching loss | | E_{off} | - | 0.29 | - | |
| Total switching loss | | E_{ts} | - | 1.04 | - | |

AFGHL40T65SQ

ELECTRICAL CHARACTERISTICS ($T_J = 25^\circ\text{C}$ unless otherwise noted) (Continued)

| Parameter | Test Conditions | Symbol | Min | Typ | Max | Unit |
|-----------|-----------------|--------|-----|-----|-----|------|
|-----------|-----------------|--------|-----|-----|-----|------|

SWITCHING CHARACTERISTICS, INDUCTIVE LOAD

| | | | | | | |
|-------------------------|---|--------------|---|------|---|----|
| Turn-on delay time | $T_J = 175^\circ\text{C}$, $V_{CC} = 400\text{ V}$, $I_C = 20\text{ A}$, $R_G = 6\ \Omega$, $V_{GE} = 15\text{ V}$, Inductive Load, FWD: AFGHL40T65SQD | $t_{d(on)}$ | - | 14 | - | ns |
| Rise time | | t_r | - | 12 | - | |
| Turn-off delay time | | $t_{d(off)}$ | - | 81 | - | |
| Fall time | | t_f | - | 7 | - | |
| Turn-on switching loss | | E_{on} | - | 0.46 | - | mJ |
| Turn-off switching loss | | E_{off} | - | 0.22 | - | |
| Total switching loss | | E_{ts} | - | 0.68 | - | |
| Turn-on delay time | $T_J = 175^\circ\text{C}$, $V_{CC} = 400\text{ V}$, $I_C = 40\text{ A}$, $R_G = 6\ \Omega$, $V_{GE} = 15\text{ V}$, Inductive Load, FWD: AFGHL40T65SQD | $t_{d(on)}$ | - | 16 | - | ns |
| Rise time | | t_r | - | 25 | - | |
| Turn-off delay time | | $t_{d(off)}$ | - | 75 | - | |
| Fall time | | t_f | - | 38 | - | |
| Turn-on switching loss | | E_{on} | - | 1.06 | - | mJ |
| Turn-off switching loss | | E_{off} | - | 0.47 | - | |
| Total switching loss | | E_{ts} | - | 1.53 | - | |

Product parametric performance is indicated in the Electrical Characteristics for the listed test conditions, unless otherwise noted. Product performance may not be indicated by the Electrical Characteristics if operated under different conditions.

AFGHL40T65SQ

TYPICAL CHARACTERISTICS

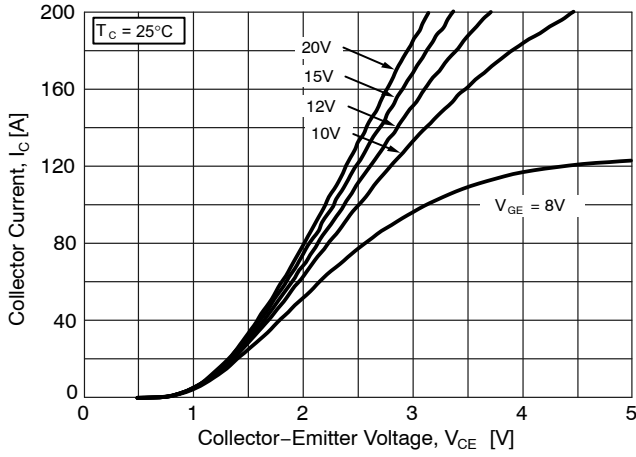

Figure 1. Typical Output Characteristics

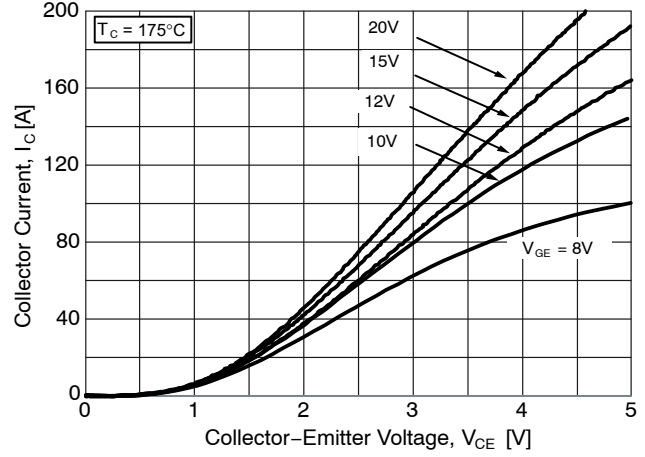

Figure 2. Typical Output Characteristics

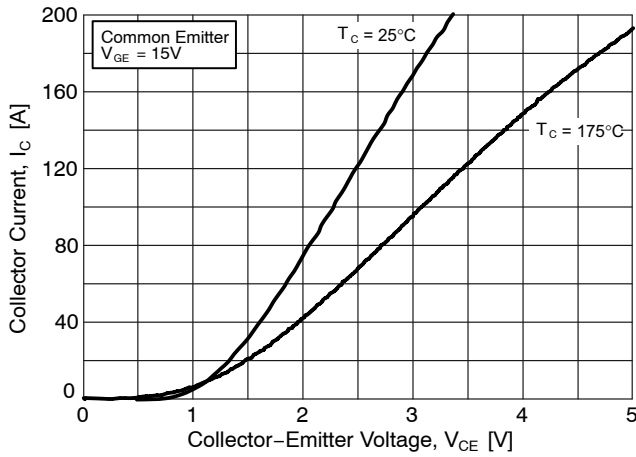

Figure 3. Typical Saturation Voltage

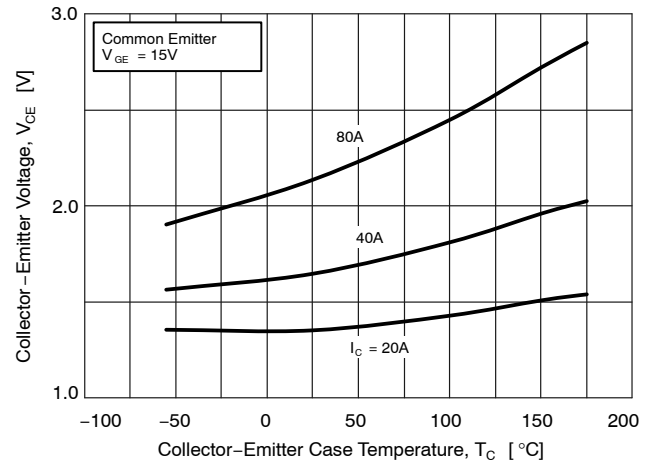

Figure 4. Saturation Voltage vs. Case Temperature

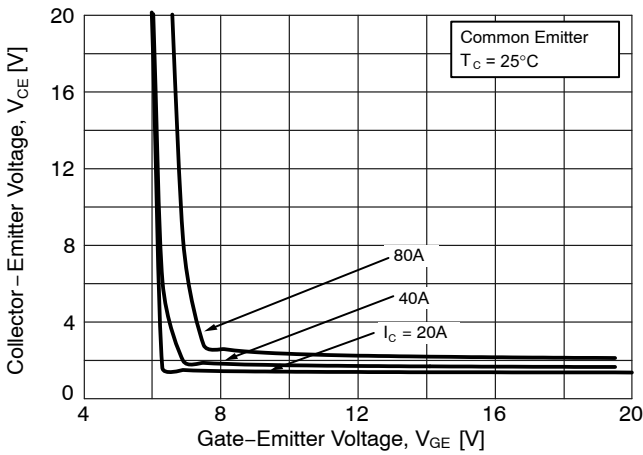

Figure 5. Saturation Voltage vs. V_{GE}

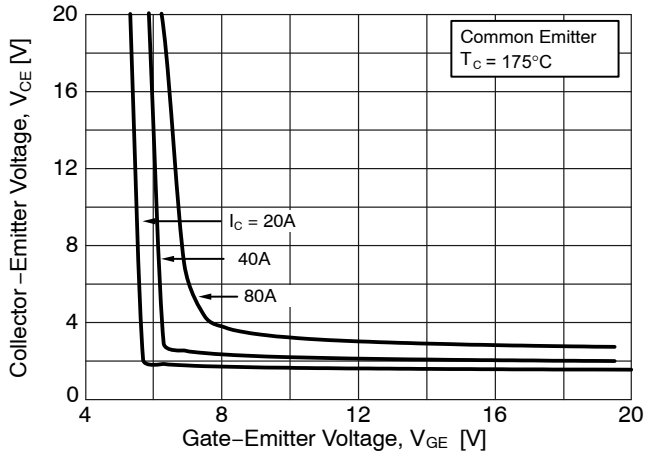

Figure 6. Saturation Voltage vs. V_{GE}

AFGHL40T65SQ

TYPICAL CHARACTERISTICS

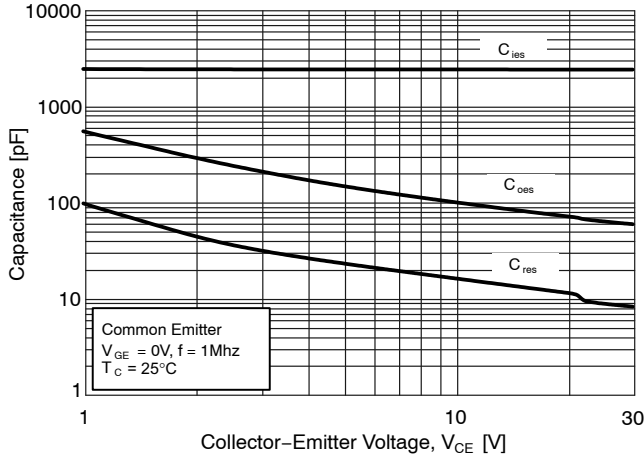

Figure 7. Capacitance Characteristics

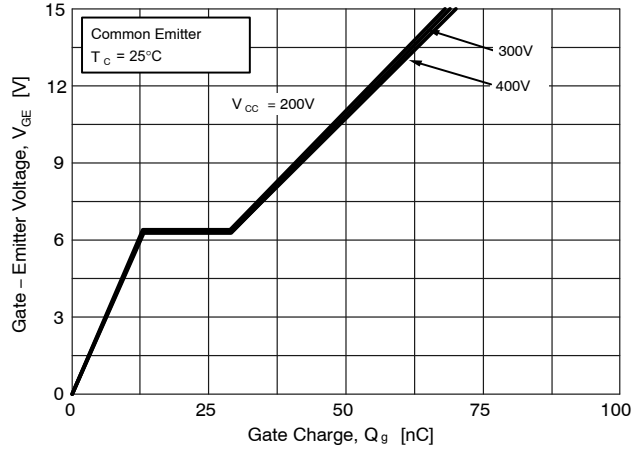

Figure 8. Gate Charge

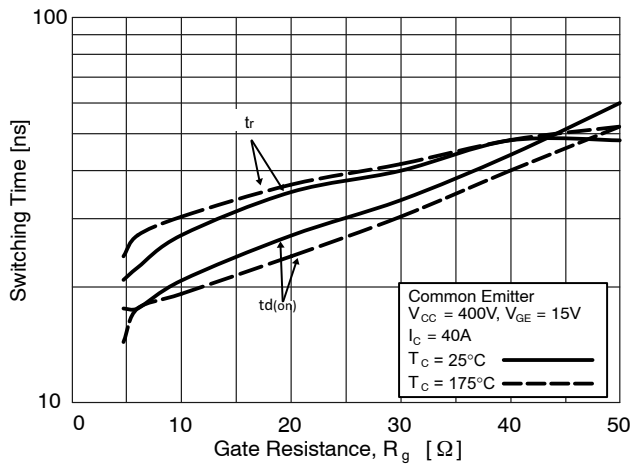

Figure 9. Turn-On Characteristics vs. Gate Resistance

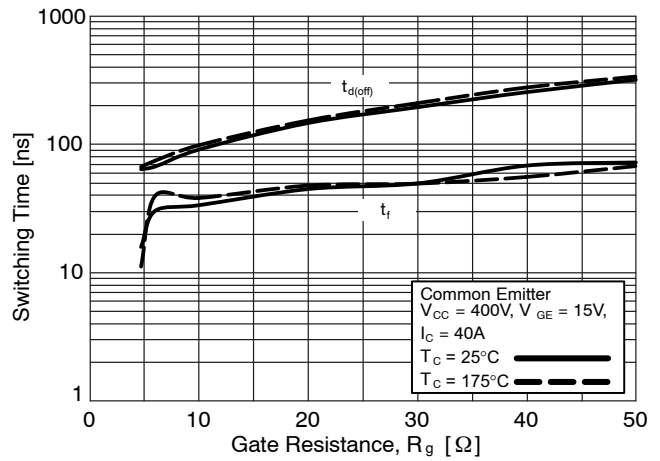

Figure 10. Turn-Off Characteristics vs. Gate Resistance

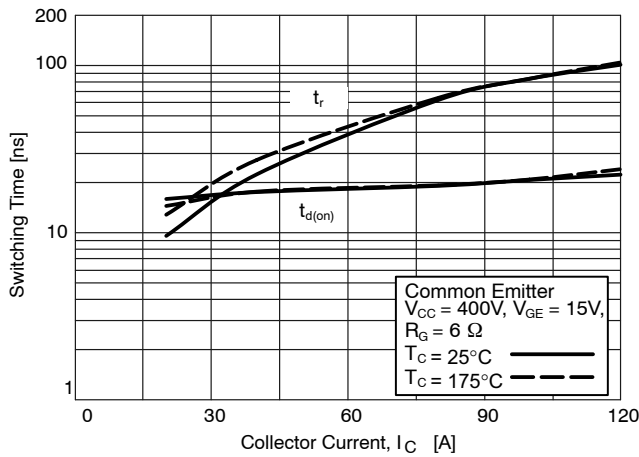

Figure 11. Turn-On Characteristics vs. Collector Current

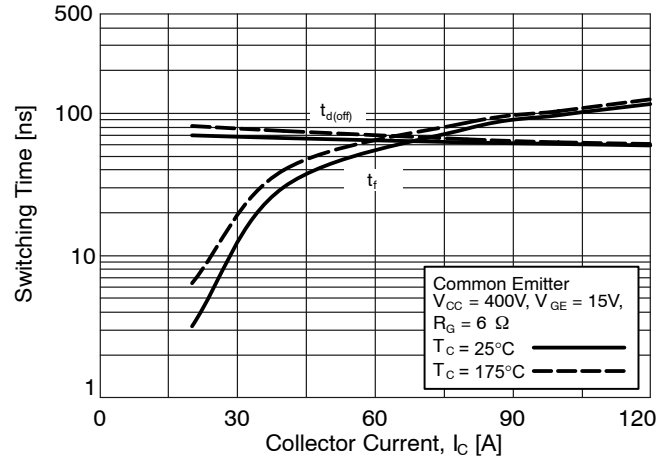

Figure 12. Turn-Off Characteristics vs. Collector Current

AFGHL40T65SQ

TYPICAL CHARACTERISTICS

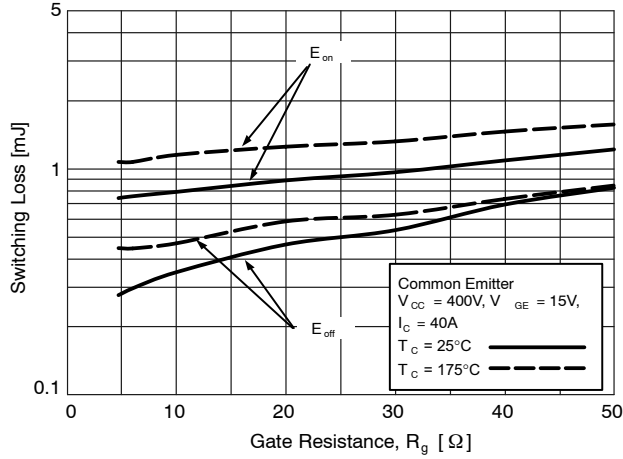

Figure 13. Switching Loss vs. Gate Resistance

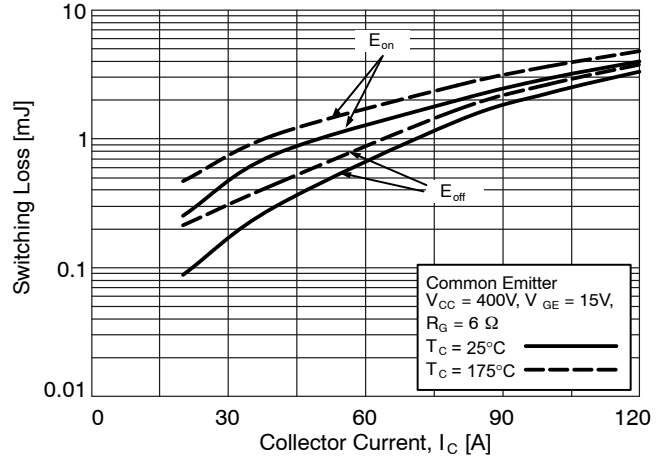

Figure 14. Switching Loss vs. Collector Current

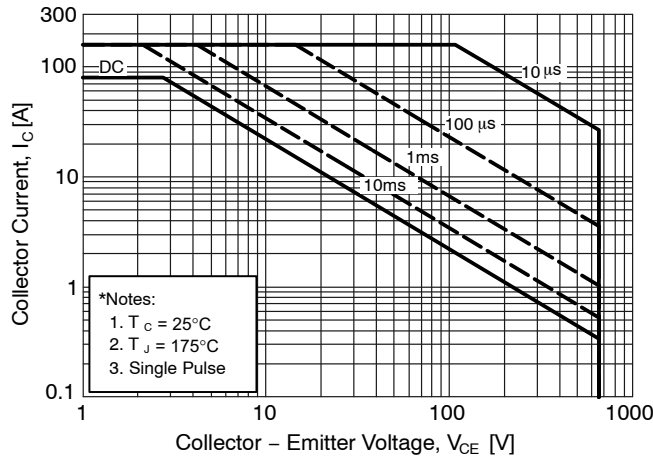

Figure 15. SOA Characteristics

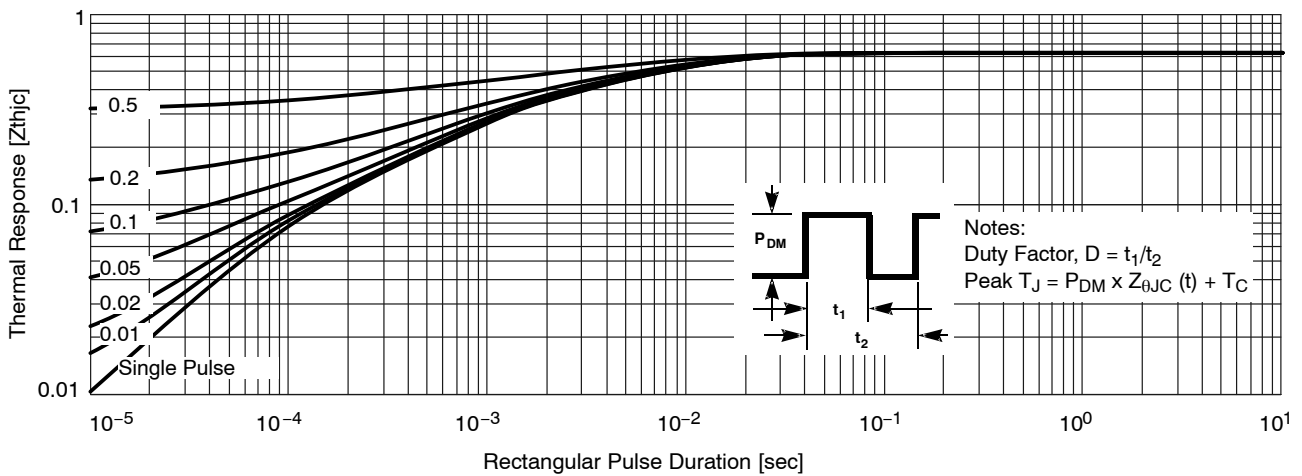
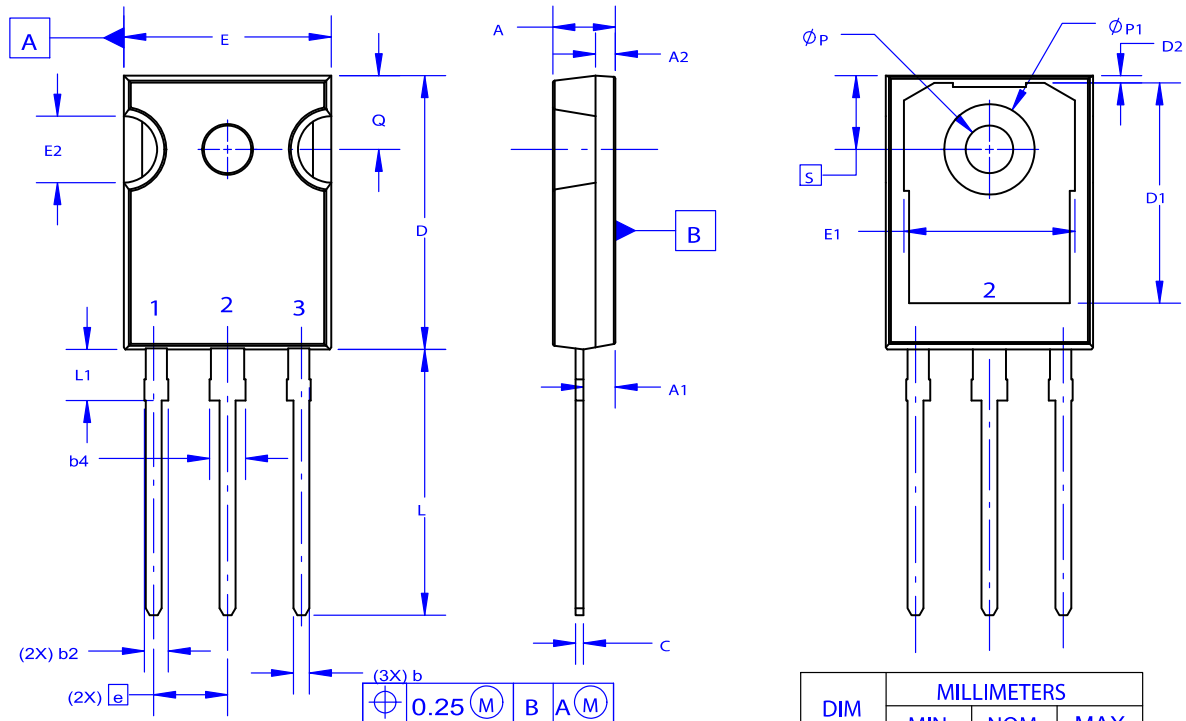

Figure 16. transient Thermal Impedance of IGBT

AFGHL40T65SQ

PACKAGE DIMENSIONS

TO-247-3LD
CASE 340CX
ISSUE O



NOTES: UNLESS OTHERWISE SPECIFIED.

- A. DIMENSIONS ARE EXCLUSIVE OF BURRS, MOLD FLASH, AND TIE BAR EXTRUSIONS.
- B. ALL DIMENSIONS ARE IN MILLIMETERS.
- C. DRAWING CONFORMS TO ASME Y14.5 - 2009.
- D. DIMENSION A1 TO BE MEASURED IN THE REGION DEFINED BY L1.
- E. LEAD FINISH IS UNCONTROLLED IN THE REGION DEFINED BY L1.

| DIM | MILLIMETERS | | |
|-----------|-------------|-------|-------|
| | MIN | NOM | MAX |
| A | 4.58 | 4.70 | 4.82 |
| A1 | 2.20 | 2.40 | 2.60 |
| A2 | 1.40 | 1.50 | 1.60 |
| D | 20.32 | 20.57 | 20.82 |
| E | 15.37 | 15.62 | 15.87 |
| E2 | 4.96 | 5.08 | 5.20 |
| e | ~ | 5.56 | ~ |
| L | 19.75 | 20.00 | 20.25 |
| L1 | 3.69 | 3.81 | 3.93 |
| ϕ P | 3.51 | 3.58 | 3.65 |
| Q | 5.34 | 5.46 | 5.58 |
| S | 5.34 | 5.46 | 5.58 |
| b | 1.17 | 1.26 | 1.35 |
| b2 | 1.53 | 1.65 | 1.77 |
| b4 | 2.42 | 2.54 | 2.66 |
| c | 0.51 | 0.61 | 0.71 |
| D1 | 13.08 | ~ | ~ |
| D2 | 0.51 | 0.93 | 1.35 |
| E1 | 12.81 | ~ | ~ |
| ϕ P1 | 6.60 | 6.80 | 7.00 |

AFGHL40T65SQ

ON Semiconductor and  are trademarks of Semiconductor Components Industries, LLC dba ON Semiconductor or its subsidiaries in the United States and/or other countries. ON Semiconductor owns the rights to a number of patents, trademarks, copyrights, trade secrets, and other intellectual property. A listing of ON Semiconductor's product/patent coverage may be accessed at www.onsemi.com/site/pdf/Patent-Marking.pdf. ON Semiconductor reserves the right to make changes without further notice to any products herein. ON Semiconductor makes no warranty, representation or guarantee regarding the suitability of its products for any particular purpose, nor does ON Semiconductor assume any liability arising out of the application or use of any product or circuit, and specifically disclaims any and all liability, including without limitation special, consequential or incidental damages. Buyer is responsible for its products and applications using ON Semiconductor products, including compliance with all laws, regulations and safety requirements or standards, regardless of any support or applications information provided by ON Semiconductor. "Typical" parameters which may be provided in ON Semiconductor data sheets and/or specifications can and do vary in different applications and actual performance may vary over time. All operating parameters, including "Typicals" must be validated for each customer application by customer's technical experts. ON Semiconductor does not convey any license under its patent rights nor the rights of others. ON Semiconductor products are not designed, intended, or authorized for use as a critical component in life support systems or any FDA Class 3 medical devices or medical devices with a same or similar classification in a foreign jurisdiction or any devices intended for implantation in the human body. Should Buyer purchase or use ON Semiconductor products for any such unintended or unauthorized application, Buyer shall indemnify and hold ON Semiconductor and its officers, employees, subsidiaries, affiliates, and distributors harmless against all claims, costs, damages, and expenses, and reasonable attorney fees arising out of, directly or indirectly, any claim of personal injury or death associated with such unintended or unauthorized use, even if such claim alleges that ON Semiconductor was negligent regarding the design or manufacture of the part. ON Semiconductor is an Equal Opportunity/Affirmative Action Employer. This literature is subject to all applicable copyright laws and is not for resale in any manner.

PUBLICATION ORDERING INFORMATION

LITERATURE FULFILLMENT:

Email Requests to: orderlit@onsemi.com

ON Semiconductor Website: www.onsemi.com

TECHNICAL SUPPORT

North American Technical Support:
Voice Mail: 1 800-282-9855 Toll Free USA/Canada
Phone: 011 421 33 790 2910

Europe, Middle East and Africa Technical Support:

Phone: 00421 33 790 2910

For additional information, please contact your local Sales Representative