



Technical catalogue | July 2015

ArTu PB Panelboard

ArTu PB Panelboard Index

Three-step selection process	2
Panelboard	
General information	4
Selection	5
Custom panelboard	
General information	6
Selection	7
Custom pan assembly	
General information	8
Selection	9
Incoming selection kit	10
MCCB Outgoing breaker selection	11
Accessories	
MCCB	13
Panelboard	14
Custom panelboard and pan assembly	15
 ALUS Panelboard	
General information	16
Selection	17
In-depth technical information	18
Overall dimensions	22
Lifting and overhead travelling	28
List of codes	30

ArTu PB Panelboard

Three-step selection process

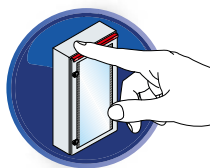

Step 1

Select the fixed Panelboard required from page 5 or Select the Custom Panelboard required from page 7 or Select the Custom Pan Assembly required from page 9.

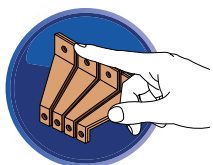

Step 2

Select the incoming device incoming kit and the inner door required from page 10.

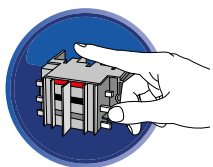

Step 3

Select the outgoing device required from page 11.
(Including the front connection terminal sets for outgoing XT1 and XT3 MCCB's)





Remember

- a) 18 way 4 pole XT3 Fixed Panelboard/Custom Panelboard & Pan Assembly equals 16 outgoing ways
- b) When ordering the incoming breaker do not forget to order the connection kit
- c) For XT1 and XT3 outgoing devices front connection terminal sets are required
- d) For breaker terminal shrouds see MCCB's breaker accessories
- e) As standard no panelboard is fitted with a plinth (see panelboard accessories)
- f) For T2 outgoing breakers see most updated MCCB's technical catalogue
- g) For the custom panelboard fill the usable space with plug-in module bases. Any left over busbar / equivalent space on the inner door should be shrouded (see custom panelboard accessories)



ArTu PB Panelboard

Panelboard

General information

The new ArTu PB Panelboard series, offers incoming options up to 800A and outgoing ways up to 400A. The ArTu PB panelboard is extremely robust, due to the newly designed metalwork system.

The ArTu PB panelboard is available wall mounted as standard, and in three configurations of 6, 12, 16 and 18 outgoing ways, giving you the ability to build your own custom panelboard.

The new system allows you to fit T1, T3, XT1 and XT3, three or four pole and the single pole MCCB's to the same copper system using the new plug in bases designed by ABB.

Side cable chambers are available in a width of 390mm which can be fitted on either side of the main structure.

There is also an option of adding top, bottom and metering extension boxes.

As standard the panelboard is fitted with a plain door but, an optional, glazed version is available.

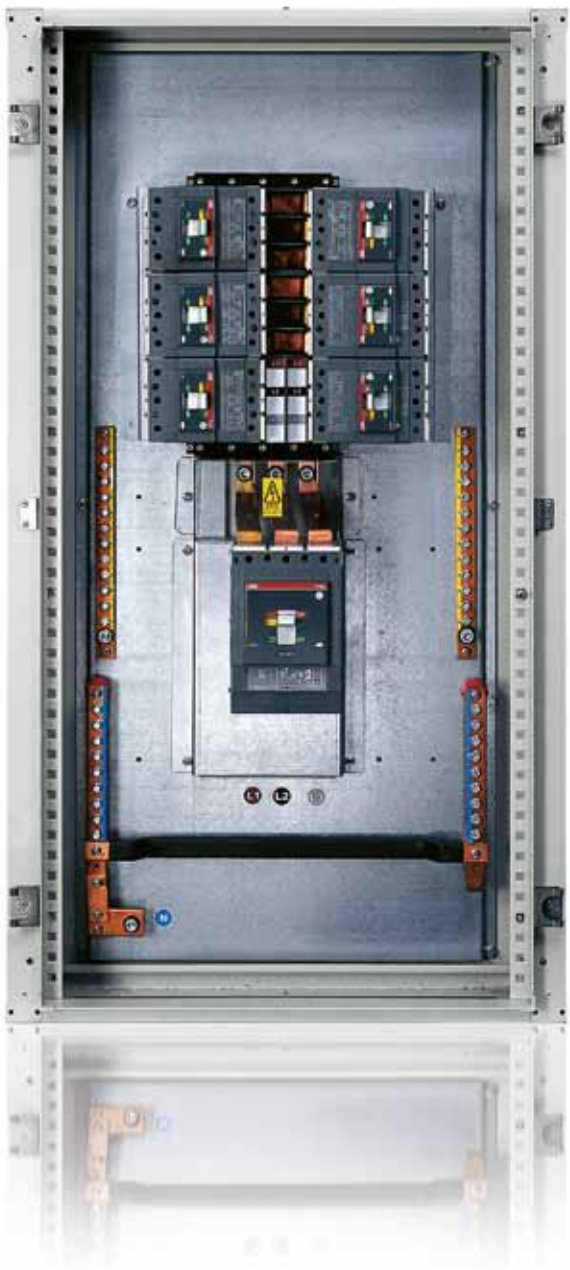

Technical characteristics

Compliance with Standards	IEC 61439-1, 2
Rated service voltage - Ue	up to 415 V
Rated insulation voltage - Ui	up to 1000 V
Rated frequency	50-60 Hz
Rated impulse withstand voltage - Uimp	8 kV
Rated current - In	1250A
Rated short-circuit short-time Withstand current - Icw	up to 65 kA
Rated short-circuit peak current - Ipk	up to 143 kA
IP degree of protection	43 with door

Selection

Step 1

Select the fixed capacity Panelboard required from the table below.



Fixed panelboard

Ways	Copper Rating	MCBB Type		3 Pole	Dimensions [mm]	4 Pole	Dimensions [mm]
6	400A	T1-XT1 outgoing	160A	640T1PB3MD	1250x690x240	640T1PB4	1250x690x240
6	400A	T3-XT3 outgoing	250A	640T3PB3MD	1250x690x240	640T3PB4	1450x690x240
6	800A	T3-XT3 outgoing	250A	680T3PB3MD	1250x690x240	680T3PB4	1450x690x240
12	400A	T1-XT1 outgoing	160A	124T1PB3MD	1650x690x240	124T1PB4	1650x690x240
12	400A	T3-XT3 outgoing	250A	124T3PB3MD	1650x690x240	124T3PB4	1850x690x240
12	800A	T1-XT1 outgoing	160A	128T1PB3MD	1650x690x240	128T1PB4	1650x690x240
12	800A	T3-XT3 outgoing	250A	128T3PB3MD	1650x690x240	128T3PB4	1850x690x240
18	400A	T1-XT1 outgoing	160A	184T1PB3MD	2050x690x240	184T1PB4	2050x690x240
18	800A	T1-XT1 outgoing	160A	188T1PB3MD	2050x690x240	188T1PB4	2050x690x240
18*	800A	T3-XT3 outgoing	250A	188T3PB3MD	2050x690x240	188T3PB4	2050x690x240

* XT3 and T3 4 pole Panelboard equals 16 outgoing ways.

ArTu PB Panelboard

Custom panelboard

General information

The new ArTu PB panelboard system gives you the flexibility to design your own custom panelboard.

There are four sizes for the custom panelboard, 6, 12, 16 and 18 outgoing ways, and can be equipped with an incoming breaker from 250A to 1250A.

Each panelboard has a fixed dimension of copper depending on the quantity of outgoing ways required. All you have to do is select the plug-in bases and fill up the copper bar to suit the breakers you need. Any remaining copper can be shrouded and MCB blanking plates can be used to fill out the inner door.



MCCB Type	Dimensions W	
	3P [mm]	4P [mm]
T1 - XT1	76.2	101.2
T2	90	120
T3 - XT3	105	140
T4	105	-
T5	139.5	-

Selection

Step 1

Select the Custom Panelboard required from the table below.

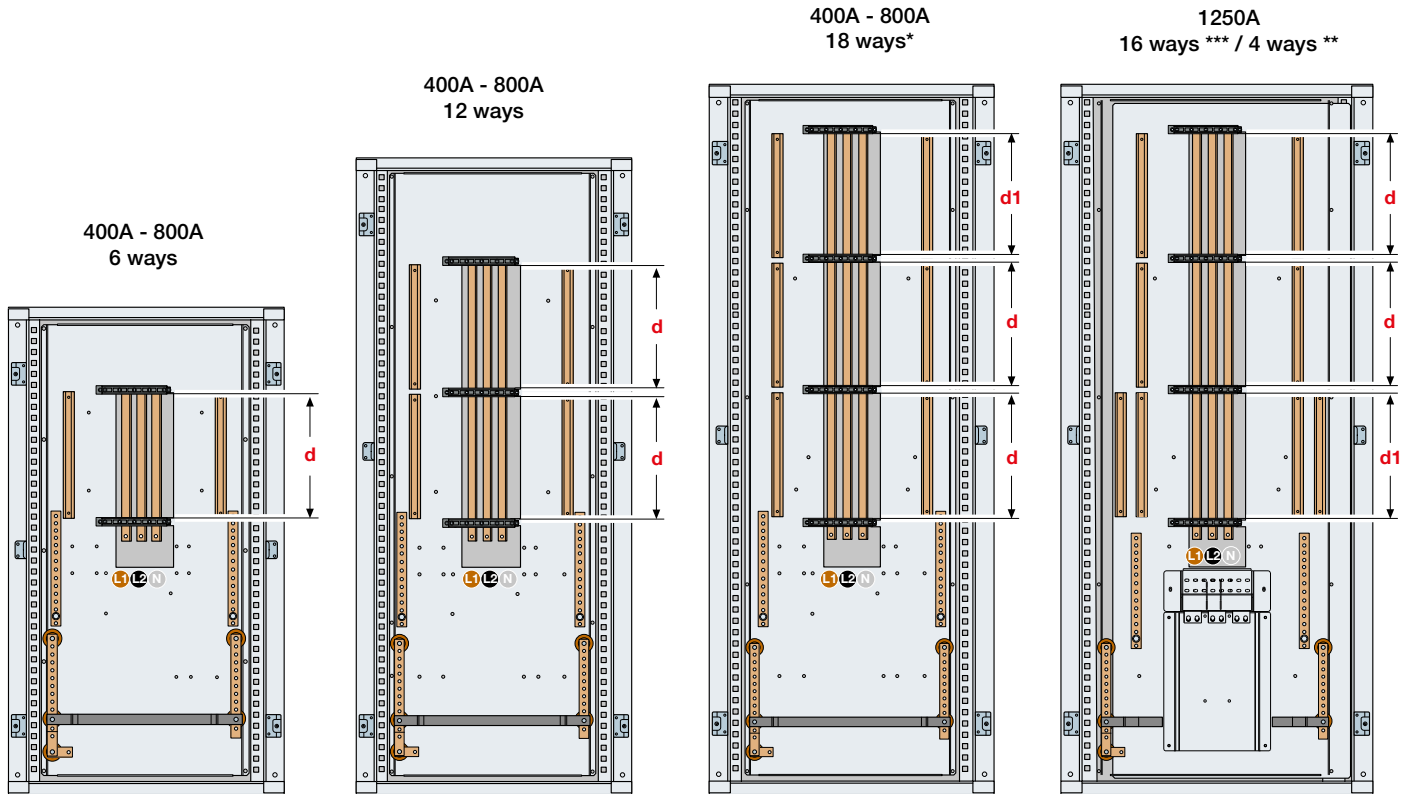

Ways	6		12		16		18	
No. poles	3	4	3	4	3	3	4	
Usable copper [d=mm]	315	420	315	420	315	315	420	
Usable copper [d1=mm]	-	-	-	-	280	315	280	
Code	400A	CU640PB3MD	-	CU124PB3MD	-	-	CU184PB3MD	-
	800A	CU680PB3MD	CU680PB4	CU128PB3MD	CU128PB4	-	CU188PB3MD	CU188PB4
	1250A	-	-	-	-	CU12504T5PB3MD	-	-

Custom Panelboard

Ways	Copper Rating	MCCB Type	3 Pole	Dimensions [mm]	4 Pole	Dimensions [mm]
6	400A	T1 single pole - T1 - T2 - T3 - XT1 - XT3	CU640PB3MD	1250x690x240	-	-
6	800A	T1 single pole - T1 - T2 - T3 - XT1 - XT3	CU680PB3MD	1250x690x240	CU680PB4	1450x690x240
12	400A	T1 single pole - T1 - T2 - T3 - XT1 - XT3	CU124PB3MD	1650x690x240	-	-
12	800A	T1 single pole - T1 - T2 - T3 - XT1 - XT3	CU128PB3MD	1650x690x240	CU128PB4	1850x690x240
18	400A	T1 single pole - T1 - T2 - T3 - XT1 - XT3	CU184PB3MD	2050x690x240	-	-
18*	800A	T1 single pole - T1 - T2 - T3 - XT1 - XT3	CU188PB3MD	2050x690x240	CU188PB4	2050x690x240
4**, 16***	1250A	T1 single pole - T1 - T2 - T3 - T4 - T5 - XT1 - XT3	CU12504T5PB3MD	2050x890x240	-	-

* XT3 and T3 4 poles breakers equals 16 outgoing ways.

** T4-T5 3 poles breakers equals 4 outgoing ways.

*** XT3 and T3 3 poles breakers equals 16 outgoing ways.

ArTu PB Panelboard Custom Pan Assembly

General information

The Pan Assembly option allows you to design your own customized switchboard. As with the panelboard, it is available in three sizes with 6, 12, 16 and 18 outgoing ways, each of which can be equipped with an incoming breaker from 250A to 800A, three or four pole.

As standard the pan assembly is supplied in three or four pole version. Each pan assembly has a fixed dimension of copper depending on the quantity of outgoing ways you require. All you have to do is select the plug-in bases and fill up the copper bar to suit the breakers. Any remaining copper can be shrouded and MCB blanking plates can be used to fill the inner door cut out.

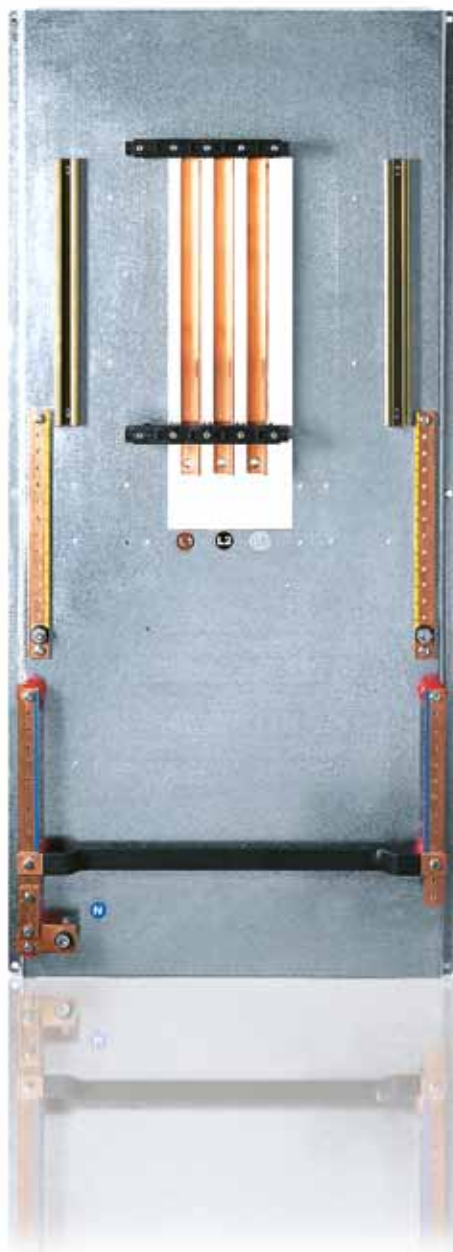

Selection

Step 1

Select the Custom Pan Assembly required from the table below.

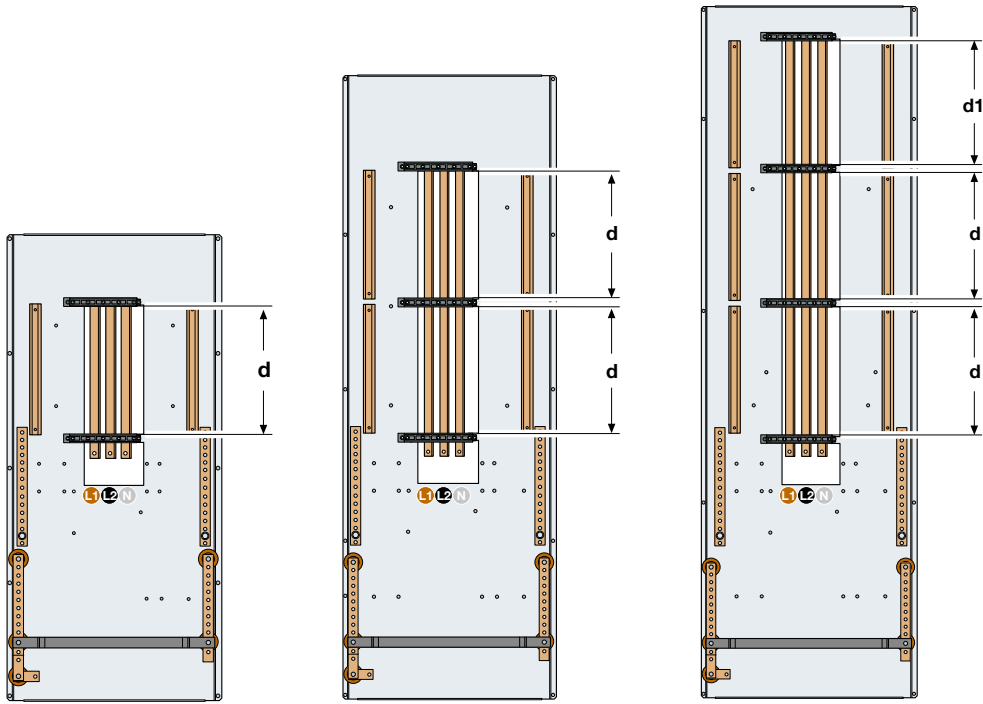

Ways	6		12		18	
No. poles	3	4	3	4	3	4
Usable copper [d=mm]	315	420	315	420	315	420
Usable copper [d1=mm]	-	-	-	-	315	280
Code	CU640PA3MD	-	CU124PA3MD	-	CU184PA3MD	-
	CU680PA3MD	CU680PA4	CU128PA3MD	CU128PA4	CU188PA3MD	CU188PA4

Custom Pan Assembly

Ways	Copper Rating	MCCB Type	3 Pole	Dimensions [mm]	4 Pole	Dimensions [mm]
6	400A	T1 single pole - T1 - T2 - T3 - XT1 - XT3	CU640PA3MD	1177x544x105	-	-
6	800A	T1 single pole - T1 - T2 - T3 - XT1 - XT3	CU680PA3MD	1177x544x105	CU680PA4	1377x544x105
12	400A	T1 single pole - T1 - T2 - T3 - XT1 - XT3	CU124PA3MD	1577x544x105	-	-
12	800A	T1 single pole - T1 - T2 - T3 - XT1 - XT3	CU128PA3MD	1577x544x105	CU128PA4	1777x544x105
18	400A	T1 single pole - T1 - T2 - T3 - XT1 - XT3	CU184PA3MD	1977x544x105	-	-
18*	800A	T1 single pole - T1 - T2 - T3 - XT1 - XT3	CU188PA3MD	1977x544x105	CU188PA4	1977x544x105

* XT3 4 poles breakers equals 16 outgoing ways.

MCCB Type	Dimensions W [mm]
T1 - XT1	76.2
T2	90
T3 - XT3	105

ArTu PB Panelboard

Incoming selection kit

Step 2

Select the incoming connection kit required from the table below.



Direct connection kit

Type	3 Pole	4 Pole	Inner door
400A Busbar rating	400DC3/4P	400DC3/4P	P6X6DC
800A Busbar rating	800DC3P	800DC4P	P6X6DC
1250A Busbar rating	1250DC3P	-	P8XDC

Neutral connection kit

Type	3 Pole	4 Pole	Inner door
4 pole neutral connection kit 250A		250NCT34P	
4 pole neutral connection kit 400/630A		630NCT54P	
4 pole neutral connection kit 800A		800NCT64P	

Incomer options

(Connection kits must be ordered with each incoming breaker)

Type	3 Pole	4 Pole	Inner door
250A Switch disconnecter T3D250	1SDA068210RI	1SDA068211RI	
250A MCCB T3N250	1SDA068059RI	1SDA068070RI	
250A MCCB connection Kit XT3	250T33P	250T34P	P6X6XT3
250A Terminals Shrouds (Pair) XT3	1SDA066668R1	1SDA066669R1	
400A MCCB connection Kit T5	400T53P	400T54P	P6X6T5
T5N 400 PR221DS-I In=400 F F	1SDA054319R1	1SDA054327R1	
T5N 400 PR221DS-LS In=400 F F	1SDA054317R1	1SDA054325R1	
400A Switch disconnecter T5D400	1SDA054599R1	1SDA054600R1	
400A Terminals Shrouds (Pair) T5	1SDA054960R1	1SDA054961R1	
630A MCCB connection kit T5	630T53P	630T54P	P6X6T5
T5N 630 PR221DS-I In=630 F F	1SDA054397R1	1SDA054401R1	
T5N 630 PR221DS-LS In=630 F F	1SDA054396R1	1SDA054396R1	
T5S 630 PR221DS-LS In=630 F F	1SDA054404R1	1SDA054408R1	
630A Switch disconnecter T5D630	1SDA054601R1	1SDA054602R1	
630A Terminals Shrouds (Pair) T5	1SDA054960R1	1SDA054961R1	
800A MCCB connection kit T6	800T63P	800T64P	P6X6T6
800A Switch disconnecter T6D800	1SDA060345R1	1SDA060346R1	
800A MCCB T6N800	1SDA060268R1	1SDA060273R1	
800A MCCB T6S800	1SDA060278R1	1SDA060283R1	
800A Terminals Shrouds (Pair) T6	1SDA014040R1	1SDA014041R1	
1250A MCCB Connection Kit T7	1250T73P		P8XT7
1250A Switch disconnecter T7D	1SDA062036R1		
1250A MCCB T7S 50kA LS/I	1SDA062866R1		
1250A Terminals Shrouds (Pair)	1SDA063091R1		

For terminal shrouds see accessories.

ArTu PB Panelboard

MCCB Outgoing breaker selection

Step 3

Select the outgoing devices required from the table below.

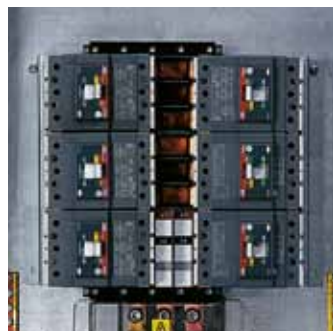

T1B Single pole MCCB

Current rating	Order code	
	1 Pole	
16A SP 16kA MCCB - T1B160 (Th/Mag)	1SDA052616R1	
20A SP 16kA MCCB - T1B160 (Th/Mag)	1SDA052617R1	
25A SP 25kA MCCB - T1B160 (Th/Mag)	1SDA052618R1	
32A SP 25kA MCCB - T1B160 (Th/Mag)	1SDA052619R1	
40A SP 25kA MCCB - T1B160 (Th/Mag)	1SDA052620R1	
50A SP 25kA MCCB - T1B160 (Th/Mag)	1SDA052621R1	
63A SP 25kA MCCB - T1B160 (Th/Mag)	1SDA052622R1	
80A SP 25kA MCCB - T1B160 (Th/Mag)	1SDA052623R1	
100A SP 25kA MCCB - T1B160 (Th/Mag)	1SDA052624R1	
125A SP 25kA MCCB - T1B160 (Th/Mag)	1SDA052625R1	
160A SP 25kA MCCB - T1B160 (Th/Mag)	1SDA052626R1	

T1B Accessories

Current rating	Order code	
	4 Pole	
SP Terminal Covers (Each)	ED0001	
SP PLUG IN BASE L1 & L3	PLT11L1/L3P	
SP PLUG IN BASE L2	PLT11L2P	

Please note each base = 2 x Devices

XT1B

Current rating	Order code	
	3 Pole	4 Pole
16A 18kA MCCB - XT1B160 (Th/Mag)	1SDA066799R1	1SDA066810R1
20A 18kA MCCB - XT1B160 (Th/Mag)	1SDA066800R1	1SDA066811R1
25A 18kA MCCB - XT1B160 (Th/Mag)	1SDA066801R1	1SDA066812R1
32A 18kA MCCB - XT1B160 (Th/Mag)	1SDA066802R1	1SDA066813R1
40A 18kA MCCB - XT1B160 (Th/Mag)	1SDA066803R1	1SDA066814R1
50A 18kA MCCB - XT1B160 (Th/Mag)	1SDA066804R1	1SDA066815R1
63A 18kA MCCB - XT1B160 (Th/Mag)	1SDA066805R1	1SDA066816R1
80A 18kA MCCB - XT1B160 (Th/Mag)	1SDA066806R1	1SDA066817R1
100A 18kA MCCB - XT1B160 (Th/Mag)	1SDA066807R1	1SDA066818R1
125A 18kA MCCB - XT1B160 (Th/Mag)	1SDA066808R1	1SDA066821R1
160A 18kA MCCB - XT1B160 (Th/Mag)	1SDA066809R1	1SDA066888R1

XT1C

Current rating	Order code	
	3 Pole	4 Pole
25A 25kA MCCB - XT1C160 (Th/Mag)	1SDA067391R1	1SDA067400R1
32A 25kA MCCB - XT1C160 (Th/Mag)	1SDA067392R1	1SDA067401R1
40A 25kA MCCB - XT1C160 (Th/Mag)	1SDA067393R1	1SDA067402R1
50A 25kA MCCB - XT1C160 (Th/Mag)	1SDA067394R1	1SDA067403R1
63A 25kA MCCB - XT1C160 (Th/Mag)	1SDA067395R1	1SDA067404R1
80A 25kA MCCB - XT1C160 (Th/Mag)	1SDA067396R1	1SDA067405R1
100A 25kA MCCB - XT1C160 (Th/Mag)	1SDA067397R1	1SDA067406R1
125A 25kA MCCB - XT1C160 (Th/Mag)	1SDA067398R1	1SDA067409R1
160A 25kA MCCB - XT1C160 (Th/Mag)	1SDA067399R1	1SDA067410R1

XT1N

Current rating	Order code	
	3 Pole	4 Pole
32A 36kA MCCB - XT1N160 (Th/Mag)	1SDA067411R1	1SDA067419R1
40A 36kA MCCB - XT1N160 (Th/Mag)	1SDA067412R1	1SDA067420R1
50A 36kA MCCB - XT1N160 (Th/Mag)	1SDA067413R1	1SDA067421R1
63A 36kA MCCB - XT1N160 (Th/Mag)	1SDA067414R1	1SDA067422R1
80A 36kA MCCB - XT1N160 (Th/Mag)	1SDA067415R1	1SDA067423R1
100A 36kA MCCB - XT1N160 (Th/Mag)	1SDA067416R1	1SDA067424R1
125A 36kA MCCB - XT1N160 (Th/Mag)	1SDA067417R1	1SDA067427R1
160A 36kA MCCB - XT1N160 (Th/Mag)	1SDA067418R1	1SDA067428R1

XT1 Accessories

Current rating	Order code	
	3 Pole	4 Pole
Front Terminal (FC Cu)	1SDA066905R1	1SDA066906R1
TP High Terminal Covers (Pair) - HTC	1SDA066664R1	1SDA066665R1
XT1 Plug in base	PLT13P	PLT13P + PLT14PMD

Please note each base = 2 x Devices

Please note 1 x FC Cu 3/4P min per Device

ArTu PB Panelboard

MCCB Outgoing breaker selection

Step 3

Select the outgoing devices required from the table below.



XT3N

Current rating	Order code	
	3 Pole	4 Pole
63A 36kA MCCB - XT3N250 (Th/Mag) - TMD	1SDA068053R1	1SDA068060R1
80A 36kA MCCB - XT3N250 (Th/Mag) - TMD	1SDA068054R1	1SDA068061R1
100A 36kA MCCB - XT3N250 (Th/Mag) - TMD	1SDA068055R1	1SDA068062R1
125A 36kA MCCB - XT3N250 (Th/Mag) - TMD	1SDA068056R1	1SDA068067R1
160A 36kA MCCB - XT3N250 (Th/Mag) - TMD	1SDA068057R1	1SDA068068R1
200A 36kA MCCB - XT3N250 (Th/Mag) - TMD	1SDA068058R1	1SDA068069R1
250A 36kA MCCB - XT3N250 (Th/Mag) - TMD	1SDA068059R1	1SDA068070R1

XT3S

Current rating	Order code	
	3 Pole	4 Pole
63A 50kA MCCB - XT3N250 (Th/Mag) - TMD	1SDA068215R1	1SDA068222R1
80A 50kA MCCB - XT3N250 (Th/Mag) - TMD	1SDA068216R1	1SDA068223R1
100A 50kA MCCB - XT3N250 (Th/Mag) - TMD	1SDA068217R1	1SDA068224R1
125A 50kA MCCB - XT3N250 (Th/Mag) - TMD	1SDA068218R1	1SDA068229R1
160A 50kA MCCB - XT3N250 (Th/Mag) - TMD	1SDA068219R1	1SDA068230R1
200A 50kA MCCB - XT3N250 (Th/Mag) - TMD	1SDA068220R1	1SDA068231R1
250A 50kA MCCB - XT3N250 (Th/Mag) - TMD	1SDA068221R1	1SDA068232R1

XT3 Accessories

Current rating	Order code	
	3 Pole	4 Pole
Front Terminal (FC Cu)	1SDA066913R1	1SDA066914R1
TP High Terminal Covers (Pair) - HTC	1SDA066668R1	1SDA066669R1
XT3 Plug in base	PLT33P	PLT33P + PLT34PMD

Please note each base = 2 x Devices

ArTu PB Panelboard

MCCB Outgoing breaker selection



T5N

	Order code
Current rating	3 Pole
400A 36kA MCCB - T5N400 (PR221DS) - LS/I	1SDA054317R1

T5S

	Order code
Current rating	3 Pole
400A 50kA MCCB - T5N400 (PR221DS) - LS/I	1SDA054333R1

T5 Accessories

	Order code
Current rating	3 Pole
T5 TP High Terminal Shields (Pair)	1SDA054960R1
T5 PLUG IN BASE	PLT53PTMD

Please note each base = 2 x Devices

ArTu PB Panelboard Accessories

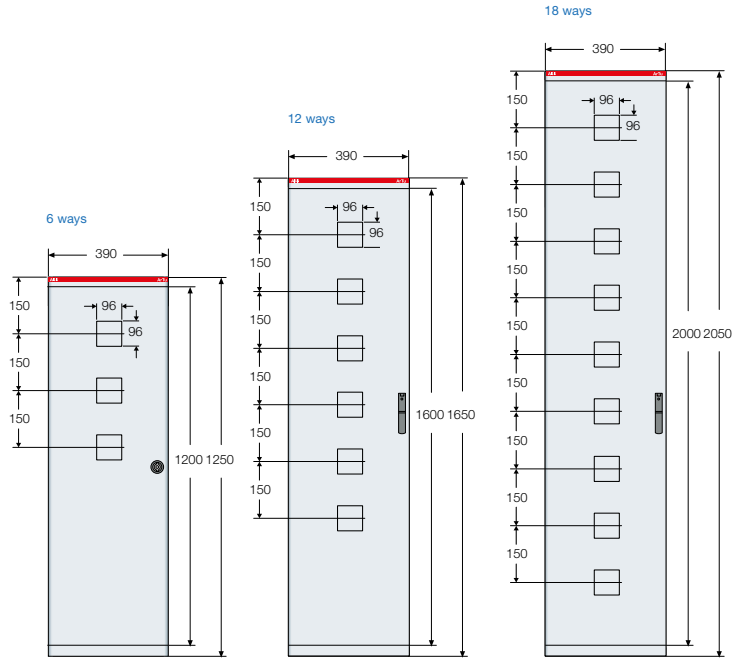

Glazed door for panelboard

Type	Order code
640T1PB3MD - 640T3PB3MD - 640T1PB4 - 680T3PB3MD - CU680PB3MD - CU640PB3MD	PV1200
640T3PB4 - 680T3PB4 - CU680PB4	PV1400
124T1PB3MD - 128T1PB3MD - 124T1PB4 - 124T3PB3MD - 128T3PB3MD - 128T1PB4 - CU128PB3MD - CU124PB3MD	PV1600
124T3PB4 - 128T3PB4 - CU128PB4	PV1800
184T1PB3MD - 188T1PB3MD - 184T1PB4 - 188T1PB4 - 188T3PB3MD - 188T3PB4 - CU188PB3MD - CU188PB4 - CU184PB3MD - CU1250T5PB3MD	PV2000

Plinth

Type	Order code
Corner feet H=100mm for structure 2 pcs.	ZL1000
Finishing profile for main structure up to 800A, W=690mm	ZL1001
Finishing profile for side cable way	ZL2001
Finishing profile for main structure W=890	ZL1101

Top/Bottom extension modules

Type	Order code
385x890x240mm HeightxWidthxDepth	RC0000
385x690x240mm HeightxWidthxDepth	RC1000
385x390x240mm HeightxWidthxDepth	RC2000

Aluminium Flange

Type	Length	Order code
Aluminium flange 250-800A	600	ALF0600
Aluminium flange 1250A	800	ALF0800

Metering chamber with side by side Kit included

Type	Height	Order code
Metering cable compartment 6way	1200	VC1206MD
Metering cable compartment 12way	1600	VC1612MD
Metering cable compartment 18way	2000	VC2018MD
Covers for unused metering 10 pcs	-	EV1136

Side extension modules for panelboard

Type	Order code		
640T1PB3MD - 640T3PB3MD - 640T1PB4 - 680T3PB3MD - CU680PB3MD - CU640PB3MD	MI1200	VC1200*	PC1202
640T3PB4 - 680T3PB4 - CU680PB4	MI1400	VC1400	PC1402
124T1PB3MD - 128T1PB3MD - 124T1PB4 - 124T3PB3MD - 128T3PB3MD - 128T1PB4 - CU128PB3MD - CU124PB3MD	MI1600	VC1600	PC1602
124T3PB4 - 128T3PB4 - CU128PB4	MI1800	VC1800	PC1802
184T1PB3MD - 188T1PB3MD - 184T1PB4 - 188T1PB4 - 188T3PB3MD - 188T3PB4 - CU188PB3MD - CU188PB4 - CU184PB3MD	MI2000	VC2000	PC2002

* Only for 640T1PB4

Metering extension modules

Type	Order code
400A Incoming Metering Kit B24-112-100	PBMET250-400*
800A Incoming Metering Kit B24-112-100	PBMET630-800*

* For ordering these code please contact GBCON, UK

Outgoing Metering Kit

Type	Order code
0-63A Outgoing Metering Kit B24-112-100	PBMET63*
80A-125A Outgoing Metering Kit B24-112-100	PBMET125*
160-250A Outgoing Metering Kit B24-112-100	PBMET250*

* For ordering these code please contact GBCON, UK

Covers for neutral and earth

Type	Note	Order code
Neutral shroud 250-800A - pair		AD1082
Neutral shroud 1250A - pair		AD1084



SH630



MODT..



Plug In device

Type	Width	Order code
T1 single pole (L1) & (L3)	25.4mm	PLT11L1/L3P
T1 single pole (L2)	25.4mm	PLT11L2P
XT1 three pole	76.2mm	PLT13P
XT1 four pole (N)	25.4mm	PLT14P
XT1 4 pole "N" plug in base	25.4mm	PLT14PMD
T2 three pole	90mm	PLT23P
T2 four pole (N)	30mm	PLT24P
T2 4 pole "N" plug in base	90mm	PLT24PMD
XT3 - T3 three pole	105mm	PLT33P
XT3 4 pole "N" plug in base	35mm	PLT34PMD
Dummy base for T1 with RCD	30mm	PLRCDT1
Dummy base for T2 with RCD	30mm	PLRCDT2
Dummy base for T3 with RCD	30mm	PLRCDT3
T4 Plug in Device three pole	105mm	PLT43PT
T5 3p plug in base *	138,5mm	PLT53PTMD

*For T5 max. 400A

Accessories

Type	Order code
Busbar shroud 630mm long 3 pcs	SH630
Busbar module shroud for XT1 10 pcs	MODT1
Busbar module shroud for T2 10 pcs	MODT2
Busbar module shroud for XT3 10 pcs	MODT3
Busbar module shroud for T4 10 pcs	MODT4
Busbar module shroud for T5 10 pcs	MODT5
Spares kit	SPARE1
Mounting brackets for T1 single pole 6 pcs	6MBT11P
Wall fixing brackets	AL2000
Covers for doors holes RAL 7035	AD1086
Neutral/earth bar additional kit	AK1NEMD
Neutral/earth bar extension kit	EX1NEMD
Neutral bar extension kit - 1250A	AN1250
1250A T4/5 cover blanks	AD1087

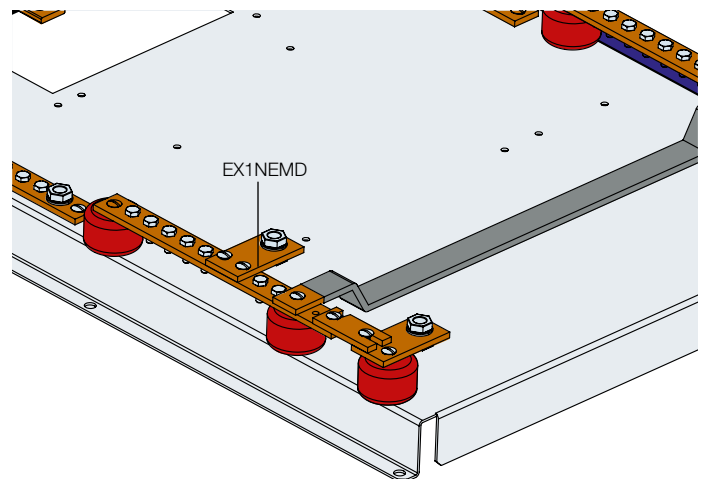
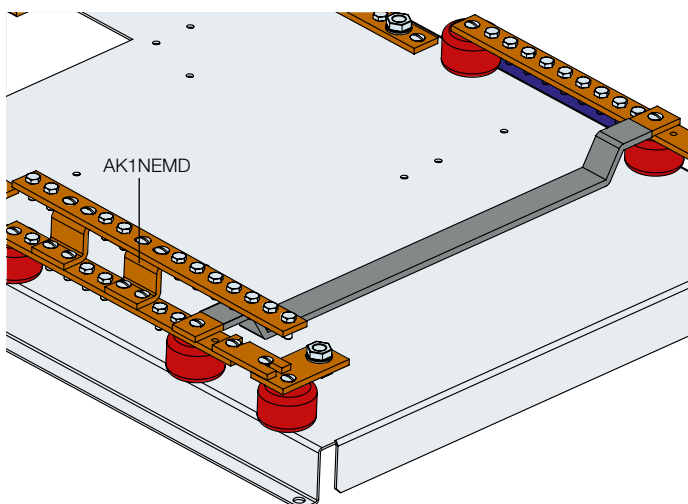

ArTu PB Panelboard and Pan Assembly

Panelboard interiors and accessories

(UL Category Code QEUY2/QEUY8)

General information

The ArTu PB UL series are suitable for applications up to 800A.

The ArTu PB UL is available in two configurations of 6 and 10 outgoing ways.

The interiors are intended to mount and provide electrical connections for circuit breakers. The main busbar system is mounted in the vertical position and the busbars finish is electrodeposited tin plate. The new system allows for T1 single pole MCCB's and T1, T2, T3, T4 and T5 three poles MCCB using the plug-in bases. The dimension of the plug-in breaker base is equivalent to a 3 poles MCCB's and the single pole base is the same width as the Tmax T1 single pole MCCB. It is possible to mount equal MCCB's on the left and on the right side of the main busbar system. Any empty ways can be fitted with a cover to insulate the live parts.

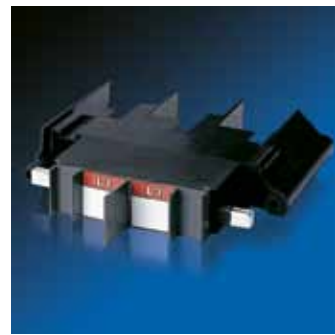
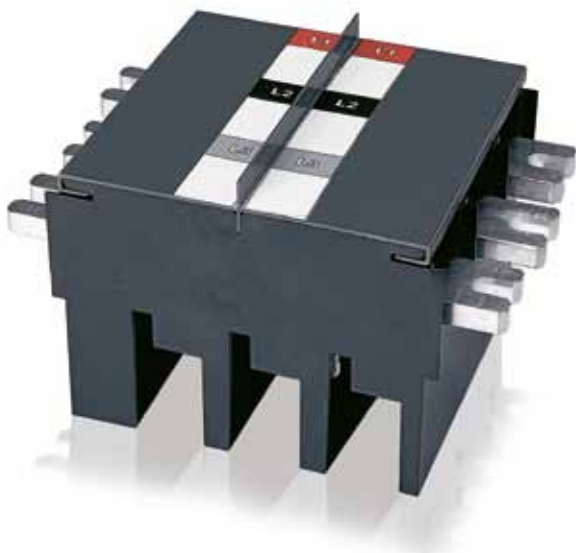

Technical characteristics

Compliance with Standards	UL67
UL category code	QEUY2, QEUY8
UL File No.	E242144
Rated voltage	up to 480 V
Rated frequency	50-60 Hz
Rated current - in	up to 800 A
Rated short-circuit short-time Withstand current - Icw	up to 50 kA

Selection

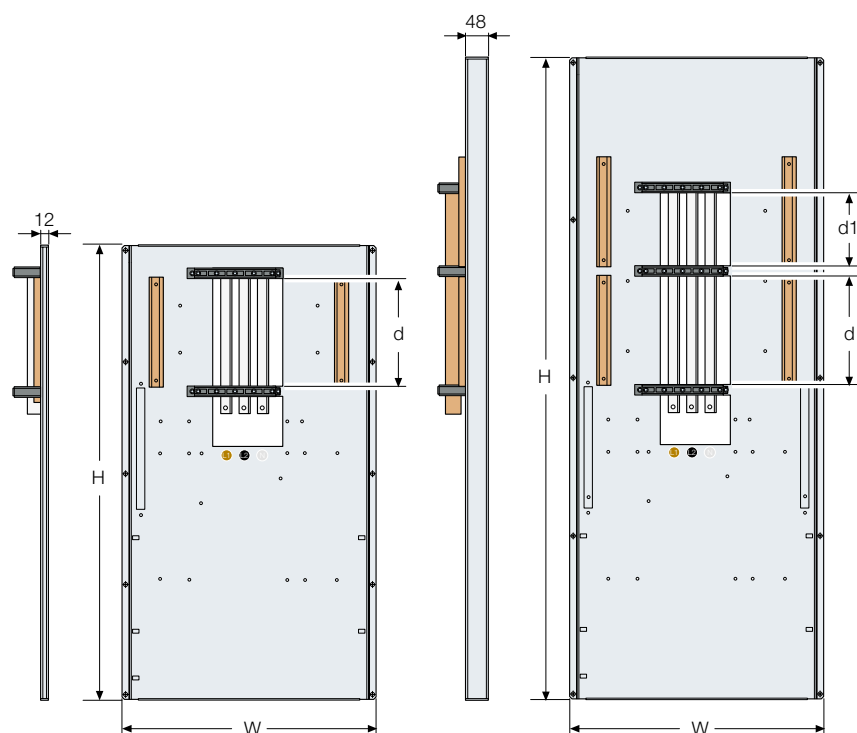

Part. Number	Usable copper (d=mm)	Usable copper (d1=mm)	H [mm]	W [mm]
640T1PU3	229	-	977	544
640T2PU3	270	-	1177	544
640T3PU3	315	-	1177	544
680T3PU3	315	-	1177	544
1040T1PU3	229	153	1377	544
1040T2PU3	270	180	1577	544
1040T3PU3	315	210	1577	544
1060T1PU2	229	153	1377	544
1060T2PU3	270	180	1577	544
1080T3PU3	315	210	1577	744

Panelboard Interiors

Ways	Copper Rating	Type	Order code
6	400A	Busbar system for 6 positions max of T1 3P	640T1PU3
6	400A	Busbar system for 6 positions max of T2 3P	640T2PU3
6	400A	Busbar system for 6 positions max of T3 3P	640T3PU3
6	800A	Busbar system for 6 positions max of T3 3P	680T3PU3
10	400A	Busbar system for 10 positions max of T1 3P	1040T1PU3
10	400A	Busbar system for 10 positions max of T2 3P	1040T2PU3
10	400A	Busbar system for 10 positions max of T3 3P	1040T3PU3
10	600A	Busbar system for 10 positions max of T1 3P	1060T1PU3
10	600A	Busbar system for 10 positions max of T2 3P	1060T2PU3
10	800A	Busbar system for 10 positions max of T3 3P	1080T3PU3(*)

UL Plug In Device

Type	Width	Order code
T1 single pole "L1" or "L3"	25.4mm	PLT11L1/L3T
T1 single pole "L2"	25.4mm	PLT11L2T
T1 three pole	76.2mm	PLT13PT
T2 three pole	90mm	PLT23PT
T3 three pole	105mm	PLT33PT
T4 three pole	105mm	PLT43PT
T5 three pole	139.5mm	PLT53PT (*)

(*) allow the fitting of any kind of Plug In Device

ArTu PB Panelboard

In-depth technical information

IP degrees of protection

1st NUMBER: protection against solid bodies

0	No protection
1	Protected against solid bodies larger than 50mm (accidental contact with hands)
2	Protected against solid bodies larger than 12 mm (fingers)
3	Protected against solid bodies larger than 2.5mm (tools, wires)
4	ArTu PB Protected against solid bodies larger than 1 mm
5	Protected against dust (no harmful deposit)
6	Totally protected against dust

1st number defined by the CEI EN 60529 – IEC 529 Standards

2nd NUMBER: protection against liquids

0	No protection
1	Protected against vertical fall of drops of water (condensation)
2	Protected against drops of water up to 15° from vertical
3	ArTu PB Protected against drops of water up to 60° from vertical
4	Protected against splashes of water from all directions
5	Protected against jets of water from all directions by means of a hose
6	Protection against jets of water similar to sea waves
7	Protected against the effects of temporary immersion
8	Protected against the effects of continual immersion

2nd number defined by the CEI EN 60529 – IEC 529 Standards

IK mechanical resistance

Figure defined by the CEI EN 50102 Standard

IK 0

Unprotected



IK 06

Impact energy in
Joule 1,00

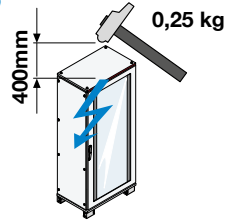

IK 01

Impact energy in
Joule 0,140

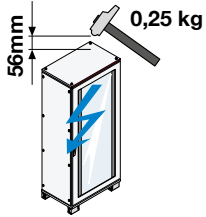

IK 07

Impact energy in
Joule 2,00



IK 02

Impact energy in
Joule 0,200

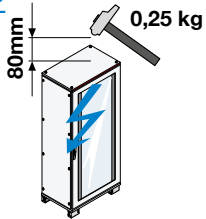

IK 08

ArTu PB
Impact energy in
Joule 5,00

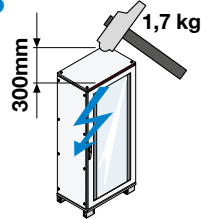

IK 03

Impact energy in
Joule 0,350

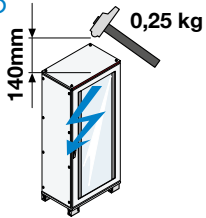

IK 09

Impact energy in
Joule 10,00

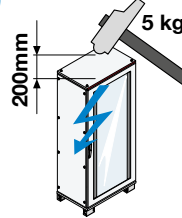

IK 04

Impact energy in
Joule 0,500

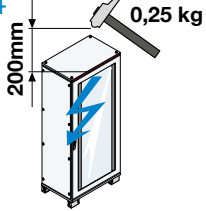

IK 10

Impact energy in
Joule 20,00

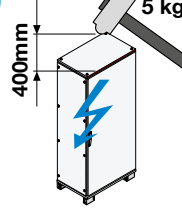

IK 05

Impact energy in
Joule 0,700

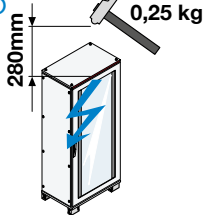

ArTu PB Panelboard

In-depth technical information

Compliance with IEC 61439-1 Standard

The ArTu PB Panelboards have undergone type tests in accordance with the IEC 61439-1 Standards. The results of these tests guarantee the performances of the ArTu switchboards and, by using the metalwork structures, ABB SACE air, modular and mouldedcase circuit-breakers, means that the end switchboard constructor does not have to carry out any further type tests when following the selection criteria and assembly instructions for the various components. These results, which are indicated below, can be referred to for the declaration of conformity of the switchboard.

Dielectric properties (Ref. par. 8.2.2 of the Standard)

	ArTu PB
Rated service voltage:	up to 690V AC
Rated insulation voltage:	up to 1000V AC
Rated impulse withstand voltage:	8kV

Short-circuit withstand current (Ref. par. 8.2.3 of the Standard)

		ArTu PB up to 400A	ArTu PB up to 800A	ArTu PB up to 1250A
Short-circuit withstand current:	phase-phase	35kA (1s)	50kA (1s)	65kA (1s)
	phase-neutral	21kA (1s)	30kA (1s)	39kA (1s)
Rated max. peak short-circuit current:		73.5kA	110kA	143kA

Short-circuit efficiency (Ref. par. 8.2.4 of the Standard)

	ArTu PB up to 400A	ArTu PB up to 800A	ArTu PB up to 1250A
(Rif. par. 8.2.4.1)	Following the assembly indications of the metal components, the effective electrical continuity between the exposed conductive parts is verified, with negligible resistance values.		
(Rif par. 8.2.4.2)	Protection circuit short-circuit withstand current: phase-earthing busbar		
	21kA (1s)	30kA (1s)	39kA (1s)

Insulation distances (Ref. par. 8.2.5. of the Standard)

The insulation distances are guaranteed by following the ABB SACE metalwork structure and circuit-breaker assembly and mounting instructions.

Mechanical operation (Ref. par. 8.2.6 of the Standard)

Mechanical operation is verified by following the assembly and mounting instructions of the ABB SACE metalwork structures and circuit-breakers.

Degree of protection (Ref. par. 8.2.7 of the Standard) According to CEI EN 60529 (CEI 70-1 publication IEC 529)

	ArTu PB
With door	IP 43

Mechanical characteristics

Material

ArTu PB structure	12/10mm thick pickled steel sheet
Panels	12/15/10mm thick steel sheet
Doors	15/10mm hot galvanised steel sheet. 4mm thick glass tempered from inside

Painting

Structure colour	Grey orange-peel RAL 7035	
Base strip colour	Grey orange-peel RAL 7012	
Standard cycle	Sheet washing Phosphating with iron salt base Drying in tunnel at 100°C External and internal painting with electrostatic application of thermosetting powder enamel with epoxy polyester binders. Grey orange-peel RAL 7035 colour, total thickness: 60/70 micron. Polymerisation in oven at 180°C.	
Paint characteristics	Binder:	eopoliestere
	Specific gravity:	1,61g/cm ³
	Theoretical coverage:	10,4 m ² /Kg. con film di spessore medio 60 micron
	Melting point:	85-95 °C (Metodo banco Kofler)
	Granulometry:	standard distribution between 5 and 100 micron with average size particles between 30 and 40 micron. Hardening: 12 min. at 190 °C (temperature of object)
	Hardness:	1H - 2H
	DIN 53152 bending elasticity:	unaltered on 1/4" spindle
	DIN 53151 reticular adherence:	GT O (100%)
	Erichem elasticity:	SEN DIN 53156: > 6mm
	Gardner resistance to impact:	25 Kg. x cm.

Tests carried out on degreased and phosphated sheets with film thickness of 60/70 micron.
The painting has passed the resistance tests to saline fog (193 hours).

Ambient characteristics

Type of installation	indoors	
Installation conditions	Wall / Floor-mounted	
Service climate (t° / r.h. %)	constant	23°C/83% - 40°C/93%
	variable	23°C/98% - 40°C/98%
Ambient temperature limits	operating	-5°C +40°C
	storage	-25°C +55°C

When correctly selected and assembled, as per the indications given in this catalogue and in the instruction manual, they allow construction of switchboards complying with the IEC 61439-1 Standard and on the basis, what is foreseen by the Low Voltage Directive of the European Community (Directive 73/23/EEC, Law 791/1977).

The above is only valid if the switchboard is designed and constructed when:

- selecting the materials according to the performances indicated in the ABB catalogues;
- sizing the conductors according to the prescriptions of the IEC 61439-1 and CEI 64-8 Standards;
- carrying out the individual tests foreseen under the IEC 61439-1 Standard successfully.

ArTu PB Panelboard

Overall Dimensions

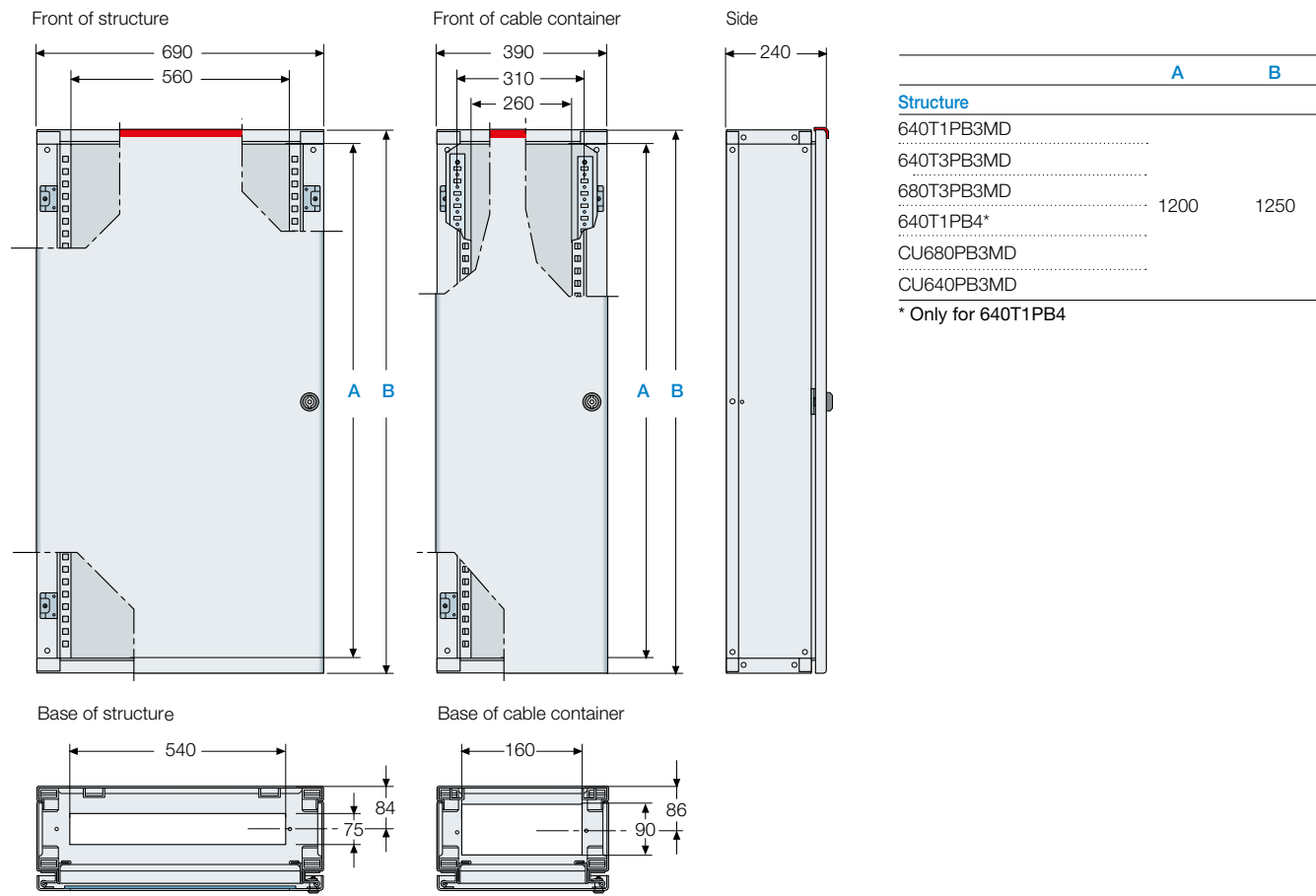

	A	B
Structure		
640T1PB3MD		
640T3PB3MD		
680T3PB3MD	1200	1250
640T1PB4*		
CU680PB3MD		
CU640PB3MD		

* Only for 640T1PB4

Fixing to wall

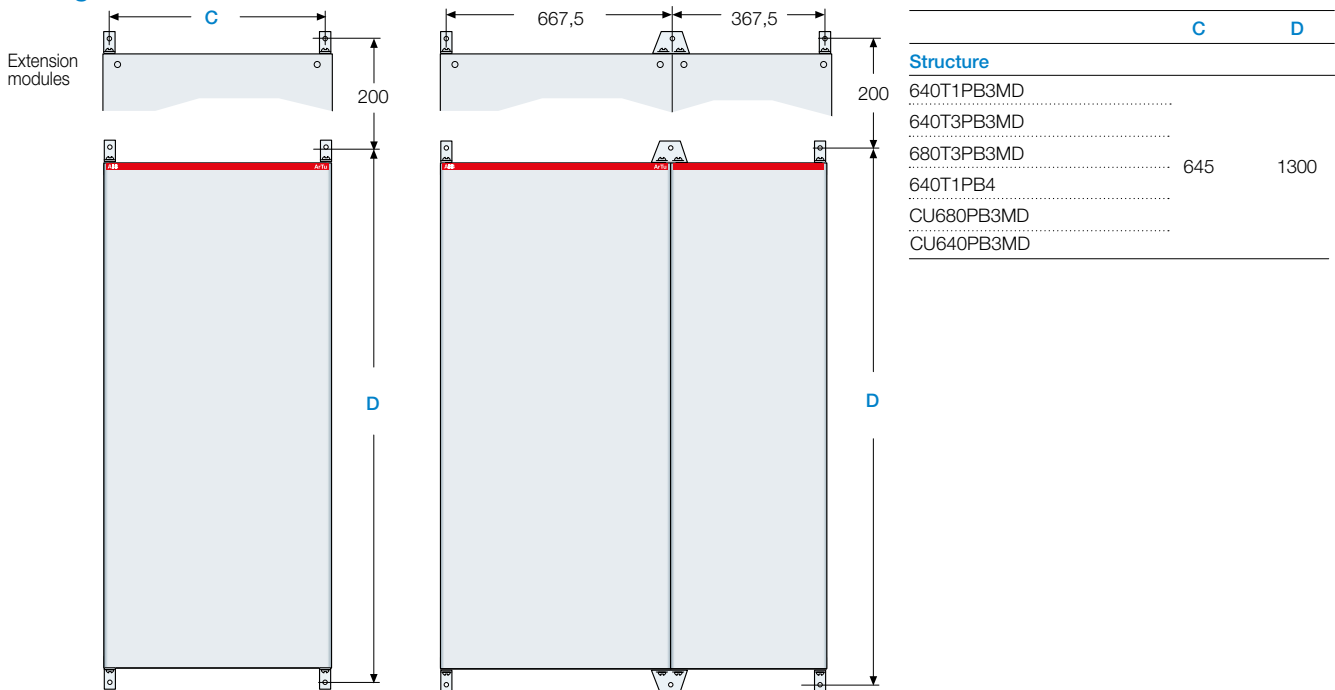

	C	D
Structure		
640T1PB3MD		
640T3PB3MD		
680T3PB3MD	645	1300
640T1PB4		
CU680PB3MD		
CU640PB3MD		

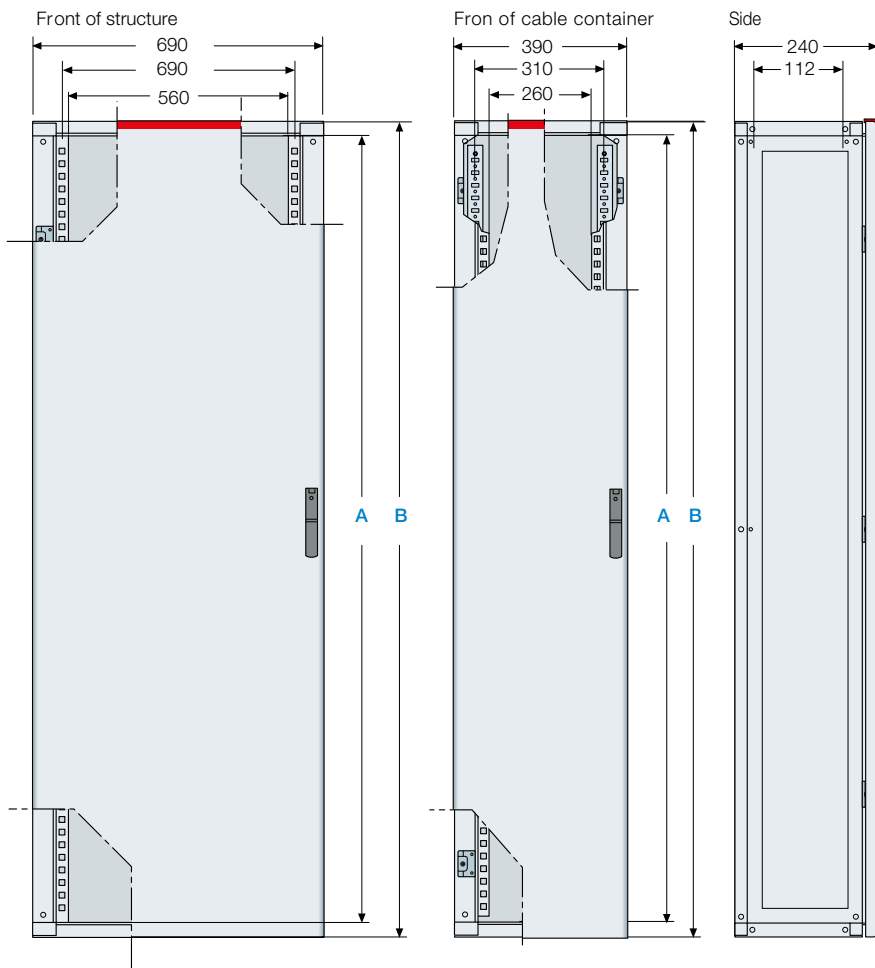

	A	B
Structure		
640T3PB4	1400	1450
680T3PB4	1400	1450
CU680PB4	1400	1450
124T1PB3MD	1600	1650
124T1PB4	1600	1650
124T3PB3MD	1600	1650
128T3PB3MD	1600	1650
124T1PB4	1600	1650
128T1PB4	1600	1650
CU124PB3MD	1600	1650
CU128PB3MD	1600	1650
124T3PB4	1800	1850
128T3PB4	1800	1850
CU128PB4	1800	1850
184T1PB3MD	2000	2050
184T1PB4	2000	2050
188T1PB3MD	2000	2050
188T1PB4	2000	2050
188T3PB3MD	2000	2050
188T3PB4	2000	2050
CU188PB3MD	2000	2050
CU188PB4	2000	2050
CU184PB3MD	2000	2050
CU12504T5PB3MD	2000	2050
Cable container		
VC1400	1400	1450
VC1600	1600	1650
VC1800	1800	1850
VC2000	2000	2050

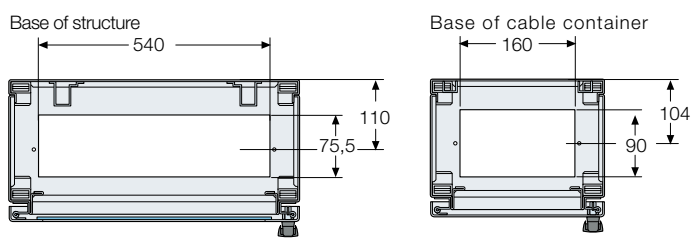

ArTu PB Custom Panelboard

Overall Dimensions

Metering chamber with side by side Kit included

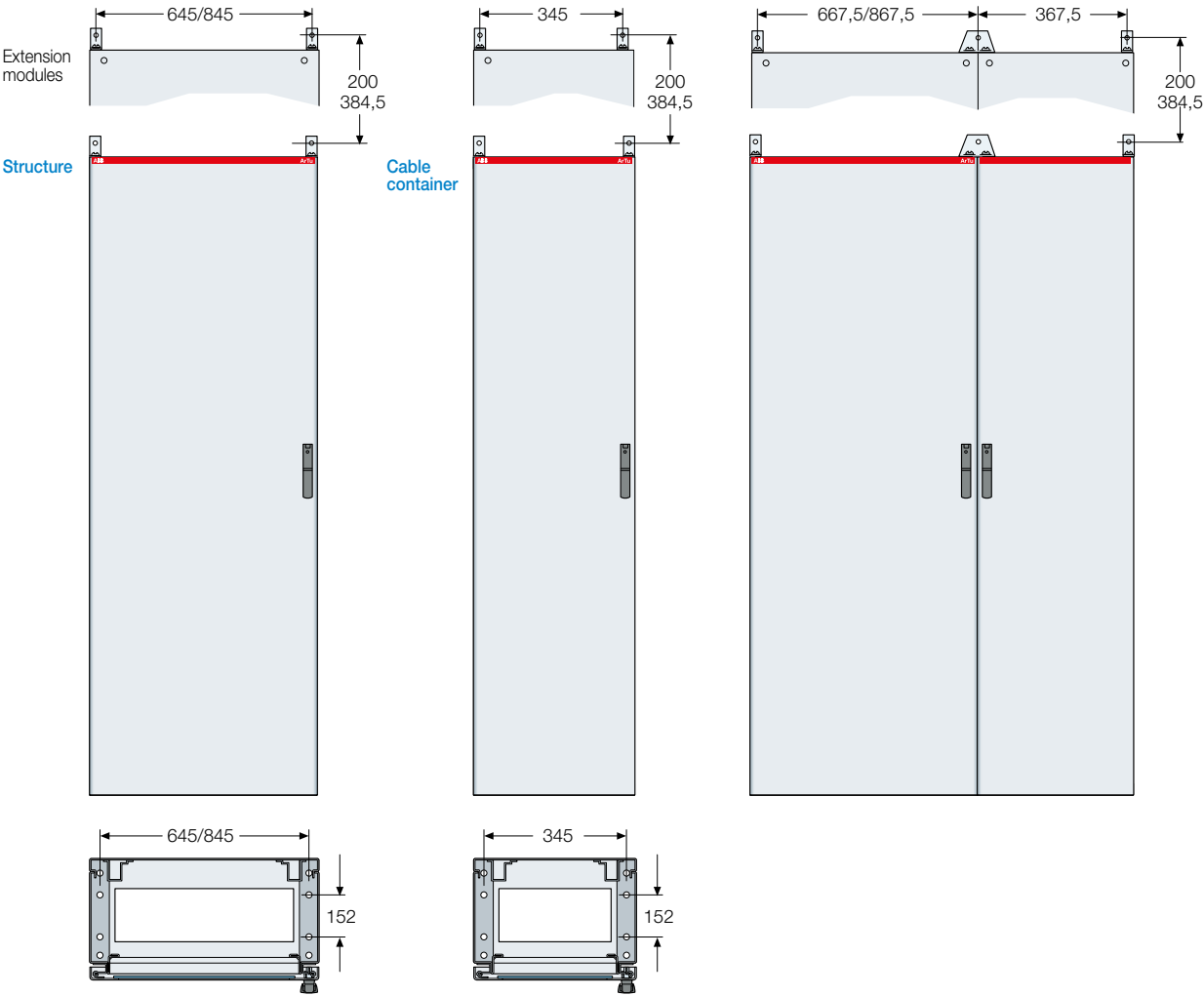

Metering chamber with side by side Kit included

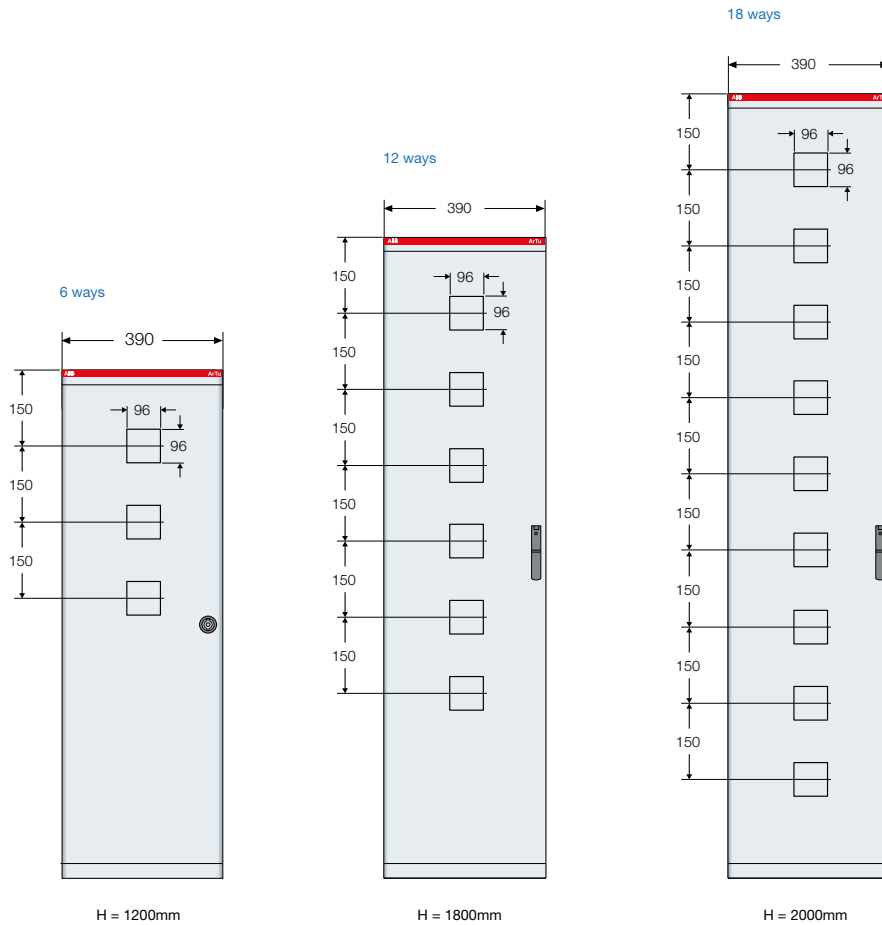

Metering chamber with side by side Kit included

Type	Height	Order code
Metering cable compartment 6way	1200	VC1206MD
Metering cable compartment 12way	1600	VC1612MD
Metering cable compartment 18way	2000	VC2018MD
Covers for unused metering 10 pcs	-	EV1136

Drilling template of the compartment door

Drilling template of the Tmax T3 inner door with flange

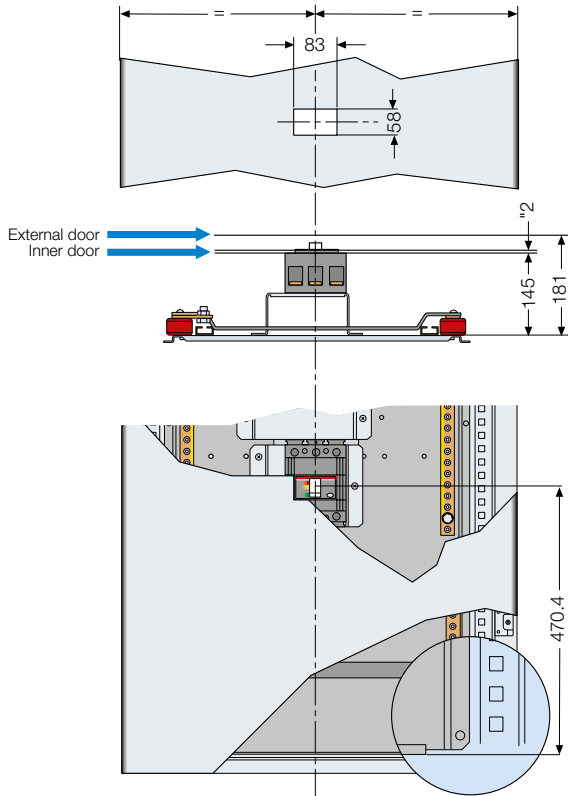

Drilling template of the Tmax T5 inner door with flange

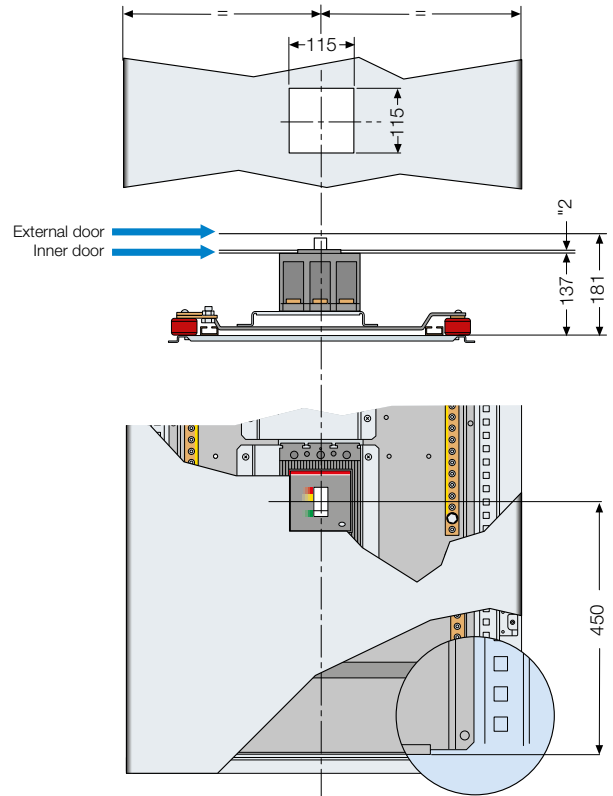

Drilling template of the Isomax S6 inner door with flange

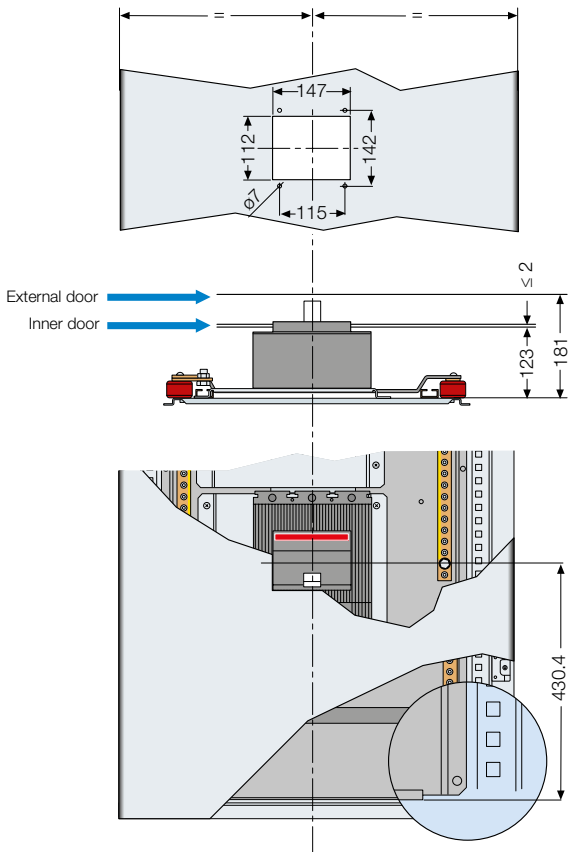

Drilling template for outgoing ways

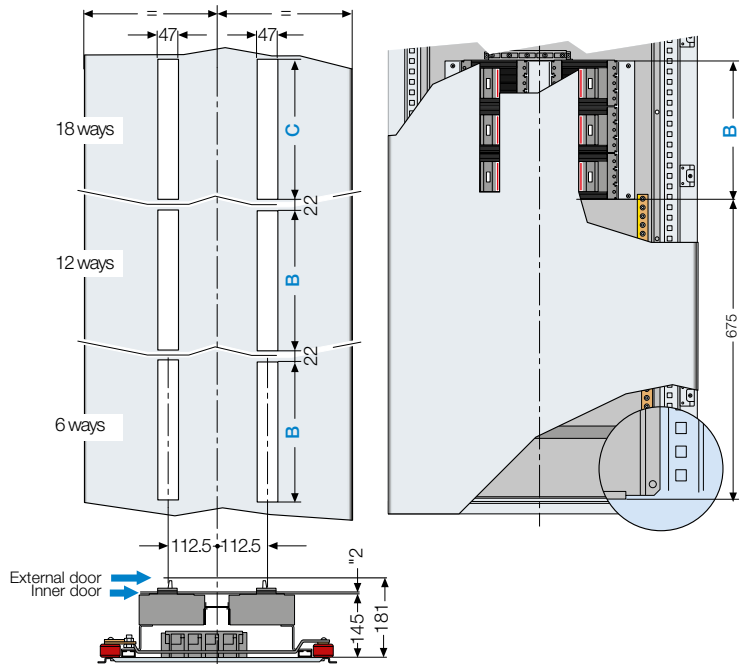

Code	B	C
CU640PA3MD	319	-
CU680PA3MD	319	-
CU680PA4	424	-
CU124PA3MD	319	-
CU128PA3MD	319	-

Code	B	C
CU128PA4	424	-
CU184PA3MD	319	319
CU188PA3MD	319	319
CU188PA4	424	284

ArTu PB Panelboard

Lifting and overhead travelling

Handling

Handling with transpallet

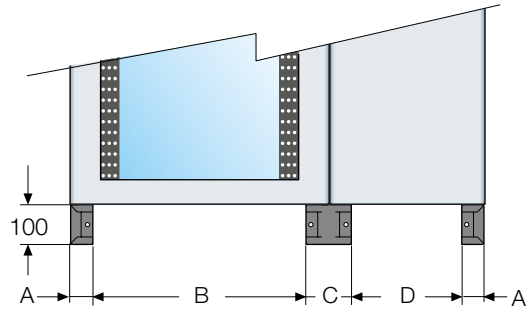
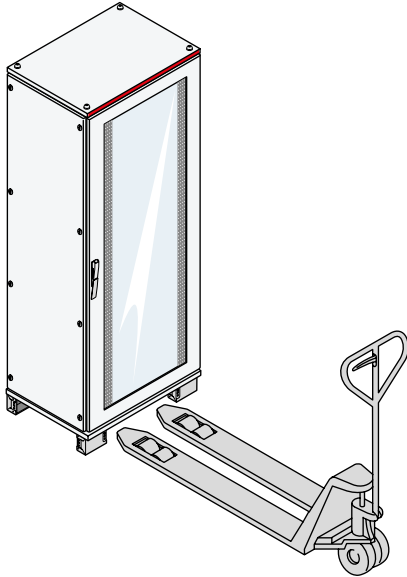

Dimensions	A (mm)	B (mm)	C (mm)	D (mm)
ArTu PB				
Width 600mm	47	596	97	296

For greater safety during transport using a fork-lift truck, it is advisable to anchor the switchgear to the truck:

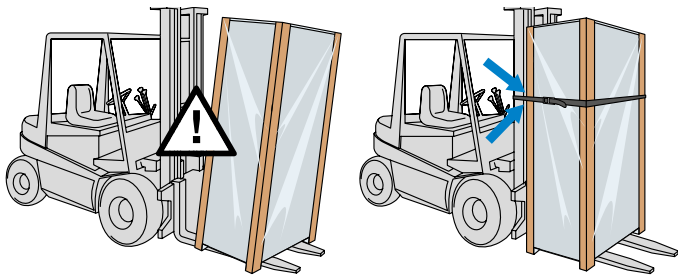

For switchgear with reduced depth, the following type of handling is recommended:

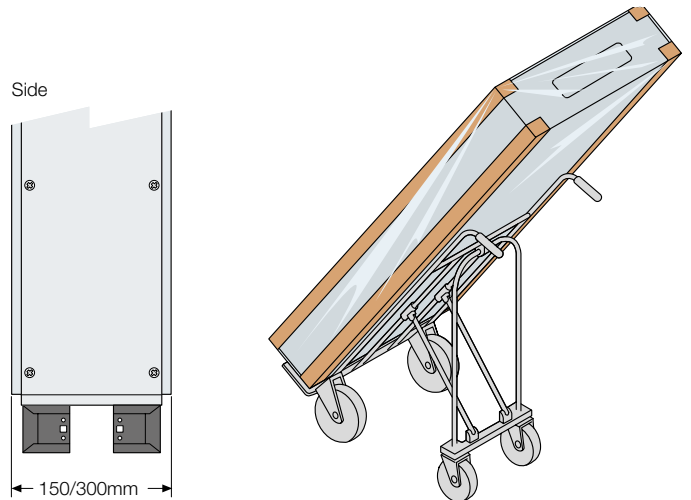

In the case of structures W=1000mm (with internal or external cable container) containing busbar systems, check the centre of gravity before handling.

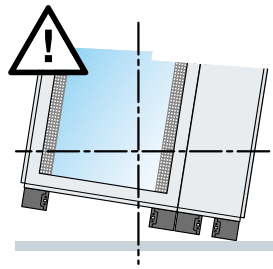
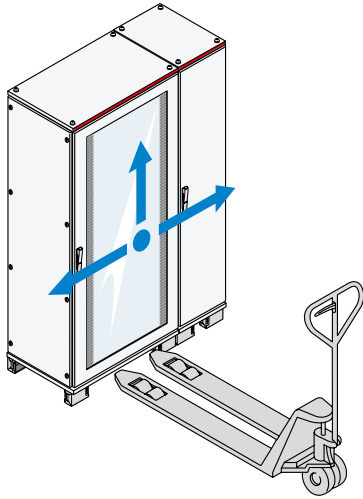

To handle using a crane or overhead travelling crane, check the following conditions before lifting the switchgear:

- state of the ropes or chains;
- the angle between the lifting ropes and the switchgear roof must be $\geq 45^\circ$;
- the maximum number of columns transported is 3;
- ArTu PB maximum weight lifted as per DIN 580 (M8);

To respect the conditions described above, a lifting beam with appropriate characteristics can be used when there are several columns side by side.

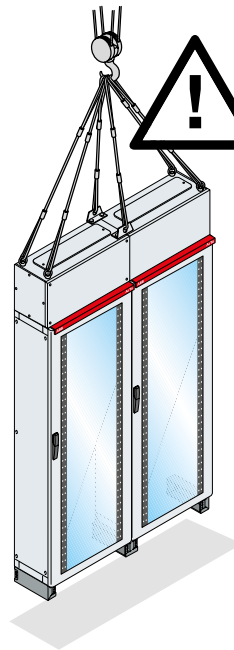

Do not lift the Artu L structures by hooking the ropes to the connection box.

ArTu PB Panelboard

List of codes

Part Number	Description	Dimensions hxwxh [mm]	Weights [Kg]	Page
Panelboard				
640T1PB3MD	400A 6 way 3 pole T1-XT1 outgoing 160A	1250x690x240	74.9	5
640T3PB3MD	400A 6 way 3 pole T3-XT3 outgoing 250A	1250x690x240	86.3	5
680T3PB3MD	800A 6 way 3 pole T3-XT3 outgoing 250A	1250x690x240	87.2	5
640T1PB4	400A 6 way 4 pole T1-XT1 outgoing 160A	1250x690x240	85.6	5
640T3PB4	400A 6 way 4 pole T3-XT3 outgoing 250A	1450x690x240	99.6	5
680T3PB4	800A 6 way 4 pole T3-XT3 outgoing 250A	1450x690x240	101.0	5
124T1PB3MD	400A 12 way 3 pole T1-XT1 outgoing 160A	1450x690x240	100.1	5
124T3PB3MD	400A 12 way 3 pole T3-XT3 outgoing 250A	1650x690x240	109.5	5
128T1PB3MD	800A 12 way 3 pole T1-XT1 outgoing 160A	1450x690x240	101.3	5
128T3PB3MD	800A 12 way 3 pole T3-XT3 outgoing 250A	1650x690x240	111.1	5
124T1PB4	400A 12 way 4 pole T1-XT1 outgoing 160A	1650x690x240	112.0	5
124T3PB4	400A 12 way 4 pole T3-XT3 outgoing 250A	1850x690x240	125.9	5
128T1PB4	800A 12 way 4 pole T1-XT1 outgoing 160A	1650x690x240	114.1	5
128T3PB4	800A 12 way 4 pole T3-XT3 outgoing 250A	1850x690x240	128.7	5
184T1PB3MD	400A 18 way 3 pole T1-XT1 outgoing 160A	1850x690x240	127.6	5
188T1PB3MD	800A 18 way 3 pole T1-XT1 outgoing 160A	1850x690x240	130.0	5
188T3PB3MD	800A 18 way 3 pole T3-XT3 outgoing 250A	2050x690x240	138.6	5
184T1PB4	400A 18 way 4 pole T1-XT1 outgoing 160A	2050x690x240	139.9	5
188T1PB4	800A 18 way 4 pole T1-XT1 outgoing 160A	2050x690x240	143.0	5
188T3PB4	800A 18 way 4 pole T3-XT3 outgoing 250A	2050x690x240	145.1	5
Custom Panelboard				
CU640PB3MD	6 Way 3 pole (400A Busbar)	1250x690x240	84.1	7
CU680PB4	6 Way 4 pole (800A Busbar)	1450x690x240	95.3	7
CU680PB3MD	6 Way 3 pole (800A Busbar)	1250x690x240	85.7	7
CU124PB3MD	12 Way 3 pole (400A Busbar)	650x690x240	104.2	7
CU128PB4	12 Way 4 pole (800A Busbar)	1850x690x240	117.3	7
CU128PB3MD	12 Way 3 pole (800A Busbar)	1650x690x240	105.9	7
CU12504T5PB3MD	4 Way 3 pole T5 outgoing 1250A	2050x690x240	–	7
CU184PB3MD	18 Way 3 pole (400A Busbar)	2050x690x240	127.2	7
CU188PB3MD	18 Way 3 pole (800A Busbar)	2050x690x240	128.7	7
CU188PB4	18 Way 4 pole (800A Busbar)	2050x690x240	131.3	7
Custom Pan Assembly				
CU640PA3MD	6 Way 3 pole (400A Busbar)	1177x544x105	17.0	9
CU680PA3MD	6 Way 3 pole (800A Busbar)	1177x544x105	18.0	9
CU680PA4	6 Way 4 pole (800A Busbar)	1377x544x105	19.0	9
CU124PA3MD	12 Way 3 pole (400A Busbar)	1577x544x105	23.0	9
CU128PA3MD	12 Way 3 pole (800A Busbar)	1577x544x105	24.0	9
CU128PA4	12 Way 4 pole (800A Busbar)	1777x544x105	25.8	9
CU184PA3MD	18 Way 3 pole (400A Busbar)	1977x544x105	29.0	9
CU188PA3MD	18 Way 3 pole (800A Busbar)	1977x544x105	27.9	9
CU188PA4	18 Way 4 pole (800A Busbar)	1977x544x105	30.5	9
Direct connection kit				
400DC3/4P	400A direct connection kit 3 and 4 pole	–	1.0	10
800DC3P	800A direct connection kit 3 pole	–	2.2	10
800DC4P	800A direct connection kit 4 pole	–	2.6	10
P6X6DC	Direct connection inner door	–	4.8	10
P8XDC	1250A direct connection inner door	–	–	10
1250DC3P	1250A Direct connection kit 3 pole	–	–	10
Neutral connection kit				
250NCT34P	4 pole neutral connection kit 250A	–	–	10

Part Number	Description	Dimensions hxwxh [mm]	Weights [Kg]	Page
630NCT54P	4 pole neutral connection kit 400/630A	–	–	10
800NCT64P	4 pole neutral connection kit 800A	–	–	10
Incomer options				
250XT33P	250A T3 3 pole MCCB connection kit	–	3.0	10
250XT34P	250A T3 4 pole MCCB connection kit	–	3.4	10
400T53P	400A T5 3 pole MCCB connection kit	–	3.6	10
400T54P	400A T5 4 pole MCCB connection kit	–	4.2	10
630T53P	630A T5 3 pole MCCB connection kit	–	3.7	10
630T54P	630A T5 4 pole MCCB connection kit	–	4.4	10
800T63P	800A T6 3 pole MCCB connection kit	–	3.1	10
800T64P	800A T6 4 pole MCCB connection kit	–	3.5	10
1250T73P	1250A T7 3 pole MCCB connection kit	–	–	10
P6X6XT3	XT3 inner door	–	–	10
P6X6T5	T5 inner door	–	7.53	10
P6X6T6	T6 inner door	–	7.53	10
P8XT7	1250A T7 inner door	–	–	10
TB1 Single pole MCCB				
1SDA052616R1	16A SP 16kA - T1B160	–	0,4	11
1SDA052617R1	20A SP 16kA - T1B160	–	0,4	11
1SDA052618R1	25A SP 25kA - T1B160	–	0,4	11
1SDA052619R1	32A SP 25kA - T1B160	–	0,4	11
1SDA052620R1	40A SP 25kA - T1B160	–	0,4	11
1SDA052621R1	50A SP 25kA - T1B160	–	0,4	11
1SDA052622R1	63A SP 25kA - T1B160	–	0,4	11
1SDA052623R1	80A SP 25kA - T1B160	–	0,4	11
1SDA052624R1	100A SP 25kA - T1B160	–	0,4	11
1SDA052625R1	125A SP 25kA - T1B160	–	0,4	11
1SDA052626R1	160A SP 25kA - T1B160	–	0,4	11
TB1 Accessories				
ED0001	SP Terminal Covers - 4 pole	–	0,2	11
PLT11L1/L3P	SP PLUG IN BASE L1 & L3 - 4 pole	–	0,3	11
PLT11L2P	SP PLUG IN BASE L2 - 4 pole	–	0,3	11
XT1B 3 Pole				
1SDA066799R1	16A 18kA - XT1B160	–	1,1	11
1SDA066800R1	20A 18kA - XT1B160	–	1,1	11
1SDA066801R1	25A 18kA - XT1B160	–	1,1	11
1SDA066802R1	32A 18kA - XT1B160	–	1,1	11
1SDA066803R1	40A 18kA - XT1B160	–	1,1	11
1SDA066804R1	50A 18kA - XT1B160	–	1,1	11
1SDA066805R1	63A 18kA - XT1B160	–	1,1	11
1SDA066806R1	80A 18kA - XT1B160	–	1,1	11
1SDA066807R1	100A 18kA - XT1B160	–	1,1	11
1SDA066808R1	125A 18kA - XT1B160	–	1,1	11
1SDA066809R1	160A 18kA - XT1B160	–	1,1	11
XT1B 4 Pole				
1SDA066810R1	16A 18kA - XT1B160	–	1,4	11
1SDA066811R1	20A 18kA - XT1B160	–	1,4	11
1SDA066812R1	25A 18kA - XT1B160	–	1,4	11
1SDA066813R1	32A 18kA - XT1B160	–	1,4	11
1SDA066814R1	40A 18kA - XT1B160	–	1,4	11

Part Number	Description	Dimensions hwxwd [mm]	Weights [Kg]	Page
1SDA066815R1	50A 18kA - XT1B160	-	1,4	11
1SDA066816R1	63A 18kA - XT1B160	-	1,4	11
1SDA066817R1	80A 18kA - XT1B160	-	1,4	11
1SDA066818R1	100A 18kA - XT1B160	-	1,4	11
1SDA066821R1	125A 18kA - XT1B160	-	1,4	11
1SDA066888R1	160A 18kA - XT1B160	-	1,4	11
XT1C 3 Pole				
1SDA067391R1	25A 25kA - XT1C160	-	1,1	11
1SDA067392R1	32A 25kA - XT1C160	-	1,1	11
1SDA067393R1	40A 25kA - XT1C160	-	1,1	11
1SDA067394R1	50A 25kA - XT1C160	-	1,1	11
1SDA067395R1	63A 25kA - XT1C160	-	1,1	11
1SDA067396R1	80A 25kA - XT1C160	-	1,1	11
1SDA067397R1	100A 25kA - XT1C160	-	1,1	11
1SDA067398R1	125A 25kA - XT1C160	-	1,1	11
1SDA067399R1	160A 25kA - XT1C160	-	1,1	11
XT1C 4 Pole				
1SDA067400R1	25A 25kA - XT1C160	-	1,4	11
1SDA067401R1	32A 25kA - XT1C160	-	1,4	11
1SDA067402R1	40A 25kA - XT1C160	-	1,4	11
1SDA067403R1	50A 25kA - XT1C160	-	1,4	11
1SDA067404R1	63A 25kA - XT1C160	-	1,4	11
1SDA067405R1	80A 25kA - XT1C160	-	1,4	11
1SDA067406R1	100A 25kA - XT1C160	-	1,4	11
1SDA067409R1	125A 25kA - XT1C160	-	1,4	11
1SDA067410R1	160A 25kA - XT1C160	-	1,4	11
XT1N 3 Pole				
1SDA067411R1	32A 36kA - XT1N160	-	1,1	11
1SDA067412R1	40A 36kA - XT1N160	-	1,1	11
1SDA067413R1	50A 36kA - XT1N160	-	1,1	11
1SDA067414R1	63A 36kA - XT1N160	-	1,1	11
1SDA067415R1	80A 36kA - XT1N160	-	1,1	11
1SDA067416R1	100A 36kA - XT1N160	-	1,1	11
1SDA067417R1	125A 36kA - XT1N160	-	1,1	11
1SDA067418R1	160A 36kA - XT1N160	-	1,1	11
XT1N 4 Pole				
1SDA067419R1	32A 36kA - XT1N160	-	1,4	11
1SDA067420R1	40A 36kA - XT1N160	-	1,4	11
1SDA067421R1	50A 36kA - XT1N160	-	1,4	11
1SDA067422R1	63A 36kA - XT1N160	-	1,4	11
1SDA067423R1	80A 36kA - XT1N160	-	1,4	11
1SDA067424R1	100A 36kA - XT1N160	-	1,4	11
1SDA067427R1	125A 36kA - XT1N160	-	1,4	11
1SDA067428R1	160A 36kA - XT1N160	-	1,4	11
XT1 Accessories				
1SDA066905R1	Front Terminal (FC Cu) 3 Pole	-	0,1	11
1SDA066906R1	Front Terminal (FC Cu) 4 Pole	-	0,1	11
1SDA066664R1	TP High Terminal Covers (Pair) - HTC 3 Pole	-	0,2	11
1SDA066665R1	TP High Terminal Covers (Pair) - HTC 4 Pole	-	0,3	11
PLT13P	XT1 Plug in base 3 Pole	-	0,9	11

Part Number	Description	Dimensions hwxwd [mm]	Weights [Kg]	Page
PLT13P+PLT14PMD	XT1 Plug in base 4 Pole	-	-	11
XT1N 3 Pole				
1SDA068053R1	63A 36kA - XT3N250 - TMD	-	1,7	12
1SDA068054R1	80A 36kA - XT3N250 - TMD	-	1,7	12
1SDA068055R1	100A 36kA - XT3N250 - TMD	-	1,7	12
1SDA068056R1	125A 36kA - XT3N250 - TMD	-	1,7	12
1SDA068057R1	160A 36kA - XT3N250 - TMD	-	1,7	12
1SDA068058R1	200A 36kA - XT3N250 - TMD	-	1,7	12
1SDA068059R1	250A 36kA - XT3N250 - TMD	-	1,7	12
XT3N 4 Pole				
1SDA068060R1	63A 36kA - XT3N250 - TMD	-	2,1	12
1SDA068061R1	80A 36kA - XT3N250 - TMD	-	2,1	12
1SDA068062R1	100A 36kA - XT3N250 - TMD	-	2,1	12
1SDA068067R1	125A 36kA - XT3N250 - TMD	-	2,1	12
1SDA068068R1	160A 36kA - XT3N250 - TMD	-	2,1	12
1SDA068069R1	200A 36kA - XT3N250 - TMD	-	2,1	12
1SDA068070R1	250A 36kA - XT3N250 - TMD	-	-	12
XT3S 3 Pole				
1SDA068070R1	250A 36kA - XT3N250 - TMD	-	2,1	12
1SDA068215R1	63A 50kA - XT3N250 - TMD	-	1,7	12
1SDA068216R1	80A 50kA - XT3N250 - TMD	-	1,7	12
1SDA068217R1	100A 50kA - XT3N250 - TMD	-	1,7	12
1SDA068218R1	125A 50kA - XT3N250 - TMD	-	1,7	12
1SDA068219R1	160A 50kA - XT3N250 - TMD	-	1,7	12
1SDA068220R1	200A 50kA - XT3N250 - TMD	-	1,7	12
XT3S 4 Pole				
1SDA068221R1	250A 50kA - XT3N250 - TMD	-	1,7	12
1SDA068222R1	63A 50kA - XT3N250 - TMD	-	2,1	12
1SDA068223R1	80A 50kA - XT3N250 - TMD	-	2,1	12
1SDA068224R1	100A 50kA - XT3N250 - TMD	-	2,1	12
1SDA068229R1	125A 50kA - XT3N250 - TMD	-	2,1	12
1SDA068230R1	160A 50kA - XT3N250 - TMD	-	2,1	12
1SDA068231R1	200A 50kA - XT3N250 - TMD	-	2,1	12
XT3 Accessories				
1SDA068232R1	250A 50kA - XT3N250 - TMD	-	2,1	12
1SDA066913R1	Front Terminal (FC Cu) 3 Pole	-	0,2	12
1SDA066914R1	Front Terminal (FC Cu) 4 Pole	-	0,2	12
1SDA066668R1	TP High Terminal Covers (Pair) - HTC 3 Pole	-	0,2	12
1SDA066669R1	TP High Terminal Covers (Pair) - HTC 4 Pole	-	0,3	12
PLT33P	XT3 Plug in base 3 Pole	-	1,1	12
PLT33P+PLT34PMD	XT1 Plug in base 4 Pole	-	-	12
T5N 3 Pole				
1SDA054317R1	400A 36kA - T5N400 (PR221DS) - LS/I	-	5,1	13
T5S 3 Pole				
1SDA054333R1	400A 50kA - T5N400 (PR221DS) - LS/I	-	5,1	13
T5 3 pole Accessories				
1SDA054960R1	T5 TP High Terminal Shields (Pair)	-	0,5	13
PLT53PTMD	T5 PLUG IN BASE	-	3,3	13

ArTu PB Panelboard

List of codes

Part Number	Description	Dimensions hxwx d [mm]	Weights [Kg]	Page
Enclosure accessories				
200EXMOD	200 mm High top & bottom extension box D=240mm	200x690x240	12,5	14
MI1200	Side Extension Box Uprights 1250mm	1250mm	3,3	14
MI1600	Side Extension Box Uprights 1650mm	1650mm	4,5	14
MI2000	Side Extension Box Uprights 2050mm	2050mm	5,6	14
PC1202	Side Extension Box Front Door 1250mm	1250mm	7,2	14
PC1602	Side Extension Box Front Door 1650mm	1650mm	9,5	14
PC2002	Side Extension Box Front Door 2050mm	2050mm	11,8	14
PV1200	Glazed Door 1200mm	1200h x 690w	12,3	14
PV1600	Glazed Door 1600mm	1600h x 690w	16,3	14
PV2000	Glazed Door 2000mm	2000h x 690w	20,3	14
RC0000	Top/Bottom extension modules	385x890x240	-	14
RC1000	Top/Bottom extension modules	385x690x240	14,4	14
RC2000	Top/Bottom extension modules	385x390x240	10,2	14
VC1200	Side Extension Box Cable Container (only for 640T1PB4 D=204mm)	1250mm	11,48	14
VC1600	Side Extension Box Cable Container	1650mm	14,7	14
VC2000	Side Extension Box Cable Cotainer	2050mm	17,7	14
ZL1000	Four Corner Feet 100mm High For Main Structure	-	2,5	14
ZL1001	Finishing Profile For Above Plinth	-	1,1	14
ZL2001	Finishing Profile For Side Extension Box	-	0,7	14
ZL3000	Two Feet 100mm High For Side Extension Box	-	1,5	14
New cable container and with side by side kit				
VC1206MD	Metering cable container 6way	1200mm	-	14
VC1612MD	Metering cable container 12way	1600mm	-	14
VC2018MD	Metering cable container 18way	2000mm	-	14
Covers				
AD1087	1250A T4/5 cover blanks	-	-	15
AD1082	Neutral shroud 250-800A - pair	-	-	14
AD1084	Neutral shroud 1250A - pair	-	-	14
AD2079	UN-used meter cover	-	-	14
Aluminium Flange				
ALF0600	Aluminium flange 250-800A	-	-	14
ALF0800	Aluminium flange 1250A	-	-	14
Plug In devices				
PLT11L1/L3P	T1 Single Pole L1 & L3 plug in base	-	0,3	15
PLT11L2P	T1 Single Pole L2 plug in base	-	0,3	15
PLT13P	T1 Three Pole plug in base	-	0,9	15
PLT14PMD	XT1 4 pole "N" plug in base	-	0,4	15
PLT23P	T2 Three Pole plug in base	-	1,0	15
PLT24P	T2 4 pole "N" plug in base	-	0,4	15
PLT24PMD	T2 Four Pole "N" plug in base	-	0,4	15
PLT33P	T3 Three Pole plug in base	-	1,1	15
PLT34PMD	XT3 4 pole "N" plug in base	-	1,1	15
PLT43PT	T4 Plug in device	-	1,3	15
PLT53PTMD	T5 3p plug in base	-	3,3	15
PLRCDT1	Dummy Base For T1 with RCD	-	1,2	15

Part Number	Description	Dimensions hxwx d [mm]	Weights [Kg]	Page
PLRCDT2	Dummy Base For T2 with RCD	-	1,3	15
PLRCDT3	Dummy Base For T3 with RCD	-	1,3	15
Accessories				
6MBT11P	Six mounting brackets for T1 single pole	-	1,0	15
AD1086	Covers for doors holes RAL 7035	-	3,5	15
AK1NEMD	Neutral/earth bar additional kit	-	1,3	15
AL2000	Wall fixing brackets	-	0,1	15
AN1250	Neutral bar extention kit - 1250A	-	-	15
EX1NEMD	Neutral/earth bar extention kit	-	0,3	15
MODT1	T1 Busbar Shroud 10pcs	-	0,1	15
MODT2	T2 Busbar Shroud 10pcs	-	0,1	15
MODT3	T3 Busbar Shroud 10pcs	-	0,1	15
SH630	Busbar Shroud 630mm Long 3 pcs	630mm	0,3	15
SPARE1	Spares Kit	-	0,8	15
Panelboard interiors				
640T1PU3	400A 6 way Busbar system for 6 positions max of T1 3P	-	14,0	17
640T2PU3	400A 6 way Busbar system for 6 positions max of T2 3P	-	16,0	17
640T3PU3	400A 6 way Busbar system for 6 positions max of T3 3P	-	16,0	17
680T3PU3	800A 6 way Busbar system for 6 positions max of T3 3P	-	16,0	17
1040T1PU3	400A 10 way Busbar system for 10 positions max of T1 3P	-	17,5	17
1040T2PU3	400A 10 way Busbar system for 10 positions max of T2 3P	-	18,5	17
1040T3PU3	400A 10 way Busbar system for 10 positions max of T3 3P	-	18,5	17
1060T1PU3	600A 10 way Busbar system for 10 positions max of T1 3P	-	18,5	17
1060T2PU3	600A 10 way Busbar system for 10 positions max of T2 3P	-	18,5	17
1080T3PU3	800A 10 way Busbar system for 10 positions max of T3 3P	-	21,0	17
UL Series - Plug in Device				
PLT11L1/L3T	T1 single pole "L1" or "L3" Width 25.4mm	-	0,8	17
PLT11L2T	T1 single pole "L2" Width 25.4mm	-	1,0	17
PLT13PT	T1 three pole Width 76.2mm	-	1,0	17
PLT23PT	T2 three pole Width 90mm	-	1,0	17
PLT33PT	T3 three pole Width 105mm	-	1,0	17
PLT43PT	T4 three pole Width 105mm	-	1,3	17
PLT53PT	T5 three pole Width 139.5mm	-	3,3	17

Contact us

ABB SACE

A division of ABB S.p.A.

Automation and Distribution Boards

Via Italia, 58

23846 Garbagnate Monastero (LC) - Italy

Tel: +39 031 3570.111

Fax: +39 031 3570.228

www.abb.com/lowvoltage

The data and illustrations are not binding. We reserve the right to modify the contents of this document on the basis of technical development of the products, without prior notice.

Copyright 2013 ABB. All right reserved.

1STC802005D0204 - 07 - 2015