









phase-out type semiconductor relay, 1-phase 3RF2 width 45 mm, 50 A 48-600 V / 24 V DC screw terminal for mounting on available cooling surfaces

product brand name	SIRIUS
product designation	solid-state relay
design of the product	1-pole
product type designation	3RF20
General technical data	
product function	zero-point switching
power loss [W] for rated value of the current	
• at AC in hot operating state	66 W
• at AC in hot operating state per pole	66 W
• without load current share typical	0.4 W
insulation voltage rated value	600 V
protection class IP	IP20
protection class IP on the front according to IEC 60529	IP20
shock resistance according to IEC 60068-2-27	15 g / 11 ms
vibration resistance according to IEC 60068-2-6	2 g
reference code according to IEC 81346-2	Q
Substance Prohibitance (day/month/year)	05/28/2009
SVHC substance name	Lead CAS-No. 7439-92-1 Lead monoxide (lead oxide) CAS-No. 1317-36-8 2-methyl-1-(4-methylthiophenyl)-2-morpholinopropan-1-one CAS-No. 71868-10-5 Melamine CAS-No. 108-78-1
Net Weight	0.088 kg
Main circuit	
number of poles for main current circuit	1
number of NO contacts for main contacts	1
number of NC contacts for main contacts	0
type of voltage of the operating voltage	AC
operating voltage	
• at AC	
— at 50 Hz rated value	48 ... 600 V
— at 60 Hz rated value	48 ... 600 V
operating frequency rated value	50 ... 60 Hz
relative symmetrical tolerance of the operating frequency	10 %
operating range relative to the operating voltage at AC	
• at 50 Hz	40 ... 660 V
• at 60 Hz	40 ... 660 V
operational current rated value maximum	50 A
operational current	
• at AC-1 at 400 V rated value	50 A

<ul style="list-style-type: none"> at AC-51 rated value 	50 A
<ul style="list-style-type: none"> according to UL 508 rated value 	50 A
ampacity maximum	50 A
operational current minimum	500 mA
rate of voltage rise at the thyristor for main contacts maximum permissible	1 000 V/ μ s
blocking voltage at the thyristor for main contacts maximum permissible	1 600 V
reverse current of the thyristor	10 mA
derating temperature	40 °C
surge current resistance rated value	600 A
I²t value maximum	1 800 A ² ·s
Control circuit/ Control	
type of voltage of the control supply voltage	DC
control supply voltage 1 at DC rated value maximum permissible	30 V
control supply voltage 1 at DC	15 ... 24 V
control supply voltage at DC	
<ul style="list-style-type: none"> initial value for signal <1> detection 	15 V
<ul style="list-style-type: none"> full-scale value for signal<0> recognition 	5 V
control current at minimum control supply voltage	
<ul style="list-style-type: none"> at DC 	13 mA
control current at DC rated value	15 mA
ON-delay time	1 ms; additionally max. one half-wave
OFF-delay time	1 ms; additionally max. one half-wave
Installation/ mounting/ dimensions	
fastening method side-by-side mounting	Yes
fastening method	screw fixing
design of the thread of the screw for securing the equipment	M4
tightening torque of fixing screw maximum	1.5 N·m
tightening torque [lbf·in] of fixing screw maximum	13 lbf·in
height	58 mm
width	45 mm
depth	48 mm
Connections/ Terminals	
product component removable terminal for auxiliary and control circuit	Yes
type of electrical connection	
<ul style="list-style-type: none"> for main current circuit 	screw-type terminals
<ul style="list-style-type: none"> for auxiliary and control circuit 	screw-type terminals
type of connectable conductor cross-sections	
<ul style="list-style-type: none"> for main contacts 	
<ul style="list-style-type: none"> — solid 	2x (1.5 ... 2.5 mm ²), 2x (2.5 ... 6 mm ²)
<ul style="list-style-type: none"> — finely stranded with core end processing 	2x (1 ... 2.5 mm ²), 2x (2.5 ... 6 mm ²), 1x 10 mm ²
<ul style="list-style-type: none"> for AWG cables for main contacts 	2x (14 ... 10)
connectable conductor cross-section for main contacts	
<ul style="list-style-type: none"> solid or stranded 	1.5 ... 6 mm ²
<ul style="list-style-type: none"> finely stranded with core end processing 	1 ... 10 mm ²
type of connectable conductor cross-sections	
<ul style="list-style-type: none"> for auxiliary and control contacts 	
<ul style="list-style-type: none"> — solid 	1x (0.5 ... 2.5 mm ²), 2x (0.5 ... 1 mm ²)
<ul style="list-style-type: none"> — finely stranded with core end processing 	1x (0.5 ... 2.5 mm ²), 2x (0.5 ... 1 mm ²)
<ul style="list-style-type: none"> — finely stranded without core end processing 	1x (0.5 ... 2.5 mm ²), 2x (0.5 ... 1 mm ²)
<ul style="list-style-type: none"> for AWG cables for auxiliary and control contacts 	1x (20 ... 12)
AWG number as coded connectable conductor cross section for main contacts	14 ... 10
tightening torque	
<ul style="list-style-type: none"> for main contacts with screw-type terminals 	2 ... 2.5 N·m
<ul style="list-style-type: none"> for auxiliary and control contacts with screw-type terminals 	0.5 ... 0.6 N·m

tightening torque [lbf-in]		
<ul style="list-style-type: none"> • for main contacts with screw-type terminals • for auxiliary and control contacts with screw-type terminals 	<p>7 ... 10.3 lbf-in</p> <p>4.5 ... 5.3 lbf-in</p>	
design of the thread of the connection screw		
<ul style="list-style-type: none"> • for main contacts • of the auxiliary and control contacts 	<p>M4</p> <p>M3</p>	
stripped length of the cable		
<ul style="list-style-type: none"> • for main contacts • for auxiliary and control contacts 	<p>10 mm</p> <p>7 mm</p>	
UL/CSA ratings		
operational current according to UL 508 rated value	50 A	
Electrical Safety		
touch protection on the front according to IEC 60529	finger-safe, for vertical contact from the front	
Ambient conditions		
installation altitude at height above sea level maximum	1 000 m	
ambient temperature		
<ul style="list-style-type: none"> • during operation • during storage 	<p>-25 ... +60 °C</p> <p>-55 ... +80 °C</p>	
Electromagnetic compatibility		
conducted interference		
<ul style="list-style-type: none"> • due to burst according to IEC 61000-4-4 • due to conductor-earth surge according to IEC 61000-4-5 • due to conductor-conductor surge according to IEC 61000-4-5 • due to high-frequency radiation according to IEC 61000-4-6 	<p>2 kV / 5 kHz, behavior criterion 2</p> <p>2 kV, behavior criterion 2</p> <p>1 kV, behavior criterion 2</p> <p>140 dBuV in the frequency range 0.15 ... 80 MHz, behavior criterion 1</p>	
field-based interference according to IEC 61000-4-3	80 MHz ... 1 GHz 10 V/m, behavior criterion 1	
electrostatic discharge according to IEC 61000-4-2	4 kV contact discharging / 8 kV air discharging, behavior criterion 2	
conducted HF interference emissions according to CISPR11	Class A for industrial environment	
field-bound HF interference emission according to CISPR11	Class B for the domestic, business and commercial environments	
Short-circuit protection, design of the fuse link		
<p>manufacturer's article number</p> <ul style="list-style-type: none"> • of gS fuse for semiconductor protection at NH design usable • of back-up R fuse link for semiconductor protection at NH design usable • of back-up R fuse link for semiconductor protection at cylindrical design 14 x 51 mm usable • of back-up R fuse link for semiconductor protection at cylindrical design 22 x 58 mm usable 	<p>3NE1803-0: These fuses have a smaller rated current than the semiconductor relays</p> <p>3NE8017-1</p> <p>3NC1450</p> <p>3NC2250</p>	
<p>manufacturer's article number of the gG fuse</p> <ul style="list-style-type: none"> • at NH design usable • at NH design usable note 	<p>3NA6807-6: These fuses have a smaller rated current than the semiconductor relays</p> <p>These fuses have a smaller rated current than the semiconductor relays</p>	
Approvals Certificates		
Environment	General Product Approval	
<p>Environmental Confirmations</p> 	   	
EMV	Test Certificates	other
	<p>Type Test Certificates/Test Report</p>	<p>Confirmation</p> <p>Confirmation</p> 

Further information

Information on the packaging

<https://support.industry.siemens.com/cs/ww/en/view/109813875>

Information for data generation and storage

<https://support.industry.siemens.com/cs/ww/en/view/109995012>

Information- and Downloadcenter (Catalogs, Brochures,...)

<https://www.siemens.com/ic10>

Industry Mall (Online ordering system)

<https://mall.industry.siemens.com/mall/en/en/Catalog/product?mlfb=3RF2050-1AA06>

Cax online generator

<https://support.automation.siemens.com/WW/CAXorder/default.aspx?lang=en&mlfb=3RF2050-1AA06>

Service&Support (Manuals, Certificates, Characteristics, FAQs,...)

<https://support.industry.siemens.com/cs/ww/en/ps/3RF2050-1AA06>

Image database (product images, 2D dimension drawings, 3D models, device circuit diagrams, EPLAN macros, ...)

https://www.automation.siemens.com/bilddb/cax_de.aspx?mlfb=3RF2050-1AA06&lang=en

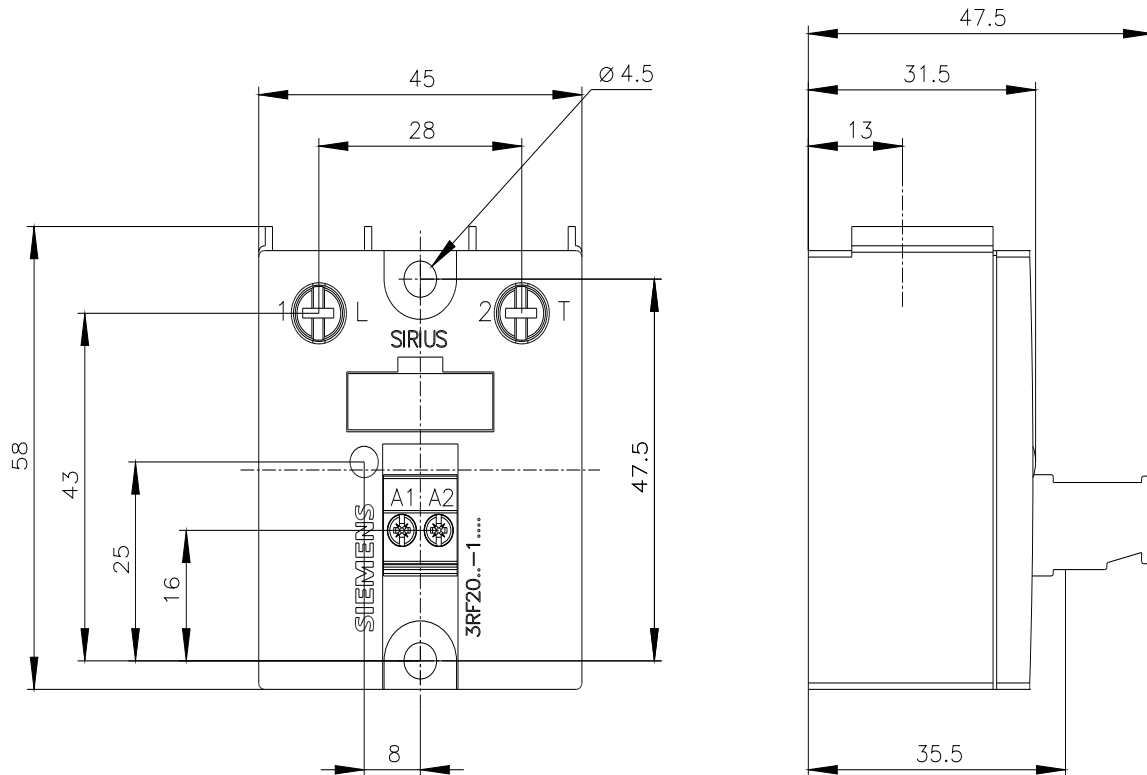

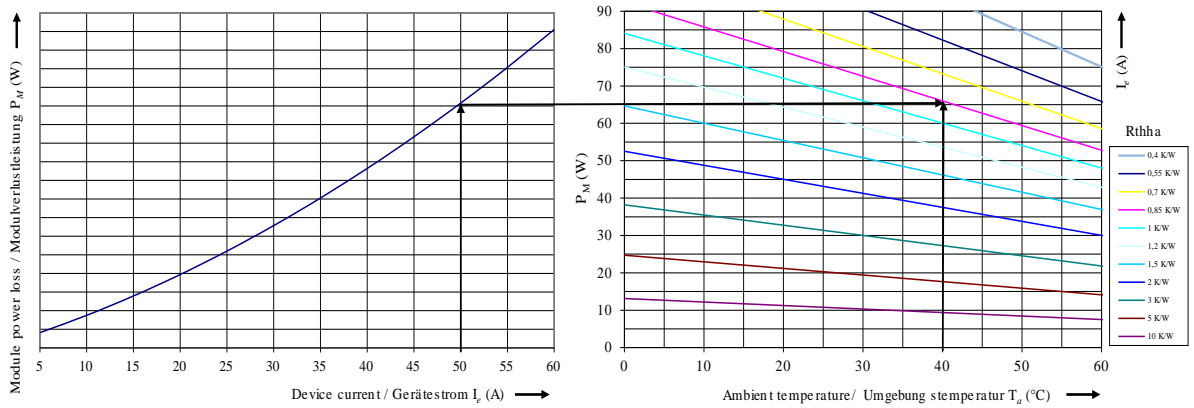

last modified:

4/4/2026