









phase-out type semiconductor relay, 1-phase 3RF2 width 45 mm, 30 A 48-600 V / 24 V DC screw terminal for mounting on available cooling surfaces

| | |
|---|--|
| product brand name | SIRIUS |
| product designation | solid-state relay |
| design of the product | 1-pole |
| product type designation | 3RF20 |
| General technical data | |
| product function | zero-point switching |
| power loss [W] for rated value of the current | |
| • at AC in hot operating state | 44.2 W |
| • at AC in hot operating state per pole | 44.2 W |
| • without load current share typical | 0.4 W |
| insulation voltage rated value | 600 V |
| protection class IP | IP20 |
| protection class IP on the front according to IEC 60529 | IP20 |
| shock resistance according to IEC 60068-2-27 | 15 g / 11 ms |
| vibration resistance according to IEC 60068-2-6 | 2 g |
| reference code according to IEC 81346-2 | Q |
| Substance Prohibitance (day/month/year) | 05/28/2009 |
| SVHC substance name | Lead CAS-No. 7439-92-1 Lead monoxide (lead oxide) CAS-No. 1317-36-8 2-methyl-1-(4-methylthiophenyl)-2-morpholinopropan-1-one CAS-No. 71868-10-5 Melamine CAS-No. 108-78-1 |
| Net Weight | 0.082 g |
| Main circuit | |
| number of poles for main current circuit | 1 |
| number of NO contacts for main contacts | 1 |
| number of NC contacts for main contacts | 0 |
| type of voltage of the operating voltage | AC |
| operating voltage | |
| • at AC | |
| — at 50 Hz rated value | 48 ... 600 V |
| — at 60 Hz rated value | 48 ... 600 V |
| operating frequency rated value | 50 ... 60 Hz |
| relative symmetrical tolerance of the operating frequency | 10 % |
| operating range relative to the operating voltage at AC | |
| • at 50 Hz | 40 ... 660 V |
| • at 60 Hz | 40 ... 660 V |
| operational current rated value maximum | 30 A |
| operational current | |
| • at AC-1 at 400 V rated value | 30 A |

| | |
|--|---|
| <ul style="list-style-type: none"> • at AC-51 rated value | 30 A |
| <ul style="list-style-type: none"> • according to UL 508 rated value | 30 A |
| ampacity maximum | 30 A |
| operational current minimum | 500 mA |
| rate of voltage rise at the thyristor for main contacts maximum permissible | 1 000 V/ μ s |
| blocking voltage at the thyristor for main contacts maximum permissible | 1 600 V |
| reverse current of the thyristor | 10 mA |
| derating temperature | 40 °C |
| surge current resistance rated value | 400 A |
| I²t value maximum | 800 A ² ·s |
| Control circuit/ Control | |
| type of voltage of the control supply voltage | DC |
| control supply voltage 1 at DC rated value maximum permissible | 30 V |
| control supply voltage 1 at DC | 15 ... 24 V |
| control supply voltage at DC | |
| <ul style="list-style-type: none"> • initial value for signal <1> detection | 15 V |
| <ul style="list-style-type: none"> • full-scale value for signal <0> recognition | 5 V |
| control current at minimum control supply voltage | |
| <ul style="list-style-type: none"> • at DC | 13 mA |
| control current at DC rated value | 15 mA |
| ON-delay time | 1 ms; additionally max. one half-wave |
| OFF-delay time | 1 ms; additionally max. one half-wave |
| Installation/ mounting/ dimensions | |
| fastening method side-by-side mounting | Yes |
| fastening method | screw fixing |
| design of the thread of the screw for securing the equipment | M4 |
| tightening torque of fixing screw maximum | 1.5 N·m |
| tightening torque [lbf·in] of fixing screw maximum | 13 lbf·in |
| height | 58 mm |
| width | 45 mm |
| depth | 48 mm |
| Connections/ Terminals | |
| product component removable terminal for auxiliary and control circuit | Yes |
| type of electrical connection | |
| <ul style="list-style-type: none"> • for main current circuit | screw-type terminals |
| <ul style="list-style-type: none"> • for auxiliary and control circuit | screw-type terminals |
| type of connectable conductor cross-sections | |
| <ul style="list-style-type: none"> • for main contacts | |
| <ul style="list-style-type: none"> — solid | 2x (1.5 ... 2.5 mm ²), 2x (2.5 ... 6 mm ²) |
| <ul style="list-style-type: none"> — finely stranded with core end processing | 2x (1 ... 2.5 mm ²), 2x (2.5 ... 6 mm ²), 1x 10 mm ² |
| <ul style="list-style-type: none"> • for AWG cables for main contacts | 2x (14 ... 10) |
| connectable conductor cross-section for main contacts | |
| <ul style="list-style-type: none"> • solid or stranded | 1.5 ... 6 mm ² |
| <ul style="list-style-type: none"> • finely stranded with core end processing | 1 ... 10 mm ² |
| type of connectable conductor cross-sections | |
| <ul style="list-style-type: none"> • for auxiliary and control contacts | |
| <ul style="list-style-type: none"> — solid | 1x (0.5 ... 2.5 mm ²), 2x (0.5 ... 1 mm ²) |
| <ul style="list-style-type: none"> — finely stranded with core end processing | 1x (0.5 ... 2.5 mm ²), 2x (0.5 ... 1 mm ²) |
| <ul style="list-style-type: none"> — finely stranded without core end processing | 1x (0.5 ... 2.5 mm ²), 2x (0.5 ... 1 mm ²) |
| <ul style="list-style-type: none"> • for AWG cables for auxiliary and control contacts | 1x (20 ... 12) |
| AWG number as coded connectable conductor cross section for main contacts | 14 ... 10 |
| tightening torque | |
| <ul style="list-style-type: none"> • for main contacts with screw-type terminals | 2 ... 2.5 N·m |
| <ul style="list-style-type: none"> • for auxiliary and control contacts with screw-type terminals | 0.5 ... 0.6 N·m |

| | | |
|---|---|---|
| tightening torque [lbf-in] | <ul style="list-style-type: none"> for main contacts with screw-type terminals for auxiliary and control contacts with screw-type terminals | 7 ... 10.3 lbf-in 4.5 ... 5.3 lbf-in |
| design of the thread of the connection screw | <ul style="list-style-type: none"> for main contacts of the auxiliary and control contacts | M4 M3 |
| stripped length of the cable | <ul style="list-style-type: none"> for main contacts for auxiliary and control contacts | 10 mm 7 mm |
| UL/CSA ratings | | |
| operational current according to UL 508 rated value | | 30 A |
| Electrical Safety | | |
| touch protection on the front according to IEC 60529 | | finger-safe, for vertical contact from the front |
| Ambient conditions | | |
| installation altitude at height above sea level maximum | | 1 000 m |
| ambient temperature | <ul style="list-style-type: none"> during operation during storage | -25 ... +60 °C -55 ... +80 °C |
| Electromagnetic compatibility | | |
| conducted interference | <ul style="list-style-type: none"> due to burst according to IEC 61000-4-4 due to conductor-earth surge according to IEC 61000-4-5 due to conductor-conductor surge according to IEC 61000-4-5 due to high-frequency radiation according to IEC 61000-4-6 | 2 kV / 5 kHz, behavior criterion 2 2 kV, behavior criterion 2 1 kV, behavior criterion 2 140 dBuV in the frequency range 0.15 ... 80 MHz, behavior criterion 1 |
| field-based interference according to IEC 61000-4-3 | | 80 MHz ... 1 GHz 10 V/m, behavior criterion 1 |
| electrostatic discharge according to IEC 61000-4-2 | | 4 kV contact discharging / 8 kV air discharging, behavior criterion 2 |
| conducted HF interference emissions according to CISPR11 | | Class A for industrial environment |
| field-bound HF interference emission according to CISPR11 | | Class B for the domestic, business and commercial environments |
| Short-circuit protection, design of the fuse link | | |
| manufacturer's article number | <ul style="list-style-type: none"> of gS fuse for semiconductor protection at NH design usable of back-up R fuse link for semiconductor protection at NH design usable of back-up R fuse link for semiconductor protection at cylindrical design 10 x 38 mm usable of back-up R fuse link for semiconductor protection at cylindrical design 14 x 51 mm usable of back-up R fuse link for semiconductor protection at cylindrical design 22 x 58 mm usable | 3NE1815-0: These fuses have a smaller rated current than the semiconductor relays 3NE8003-1 3NC1032 3NC1440 3NC2240 |
| manufacturer's article number of the gG fuse | <ul style="list-style-type: none"> at NH design usable at NH design usable note | 3NA6803-6: These fuses have a smaller rated current than the semiconductor relays These fuses have a smaller rated current than the semiconductor relays |
| Approvals Certificates | | |
| Environment | General Product Approval | |
| Environmental Confirmations |  |  |
| |  |  |
| | |  |
| EMV | Test Certificates | other |
|  | Type Test Certificates/Test Report | Confirmation |
| | | Confirmation |
| | |  |

Further information

Information on the packaging

<https://support.industry.siemens.com/cs/ww/en/view/109813875>

Information for data generation and storage

<https://support.industry.siemens.com/cs/ww/en/view/109995012>

Information- and Downloadcenter (Catalogs, Brochures,...)

<https://www.siemens.com/ic10>

Industry Mall (Online ordering system)

<https://mall.industry.siemens.com/mall/en/en/Catalog/product?mlfb=3RF2030-1AA06>

Cax online generator

<https://support.automation.siemens.com/WW/CAXorder/default.aspx?lang=en&mlfb=3RF2030-1AA06>

Service&Support (Manuals, Certificates, Characteristics, FAQs,...)

<https://support.industry.siemens.com/cs/ww/en/ps/3RF2030-1AA06>

Image database (product images, 2D dimension drawings, 3D models, device circuit diagrams, EPLAN macros, ...)

https://www.automation.siemens.com/bilddb/cax_de.aspx?mlfb=3RF2030-1AA06&lang=en

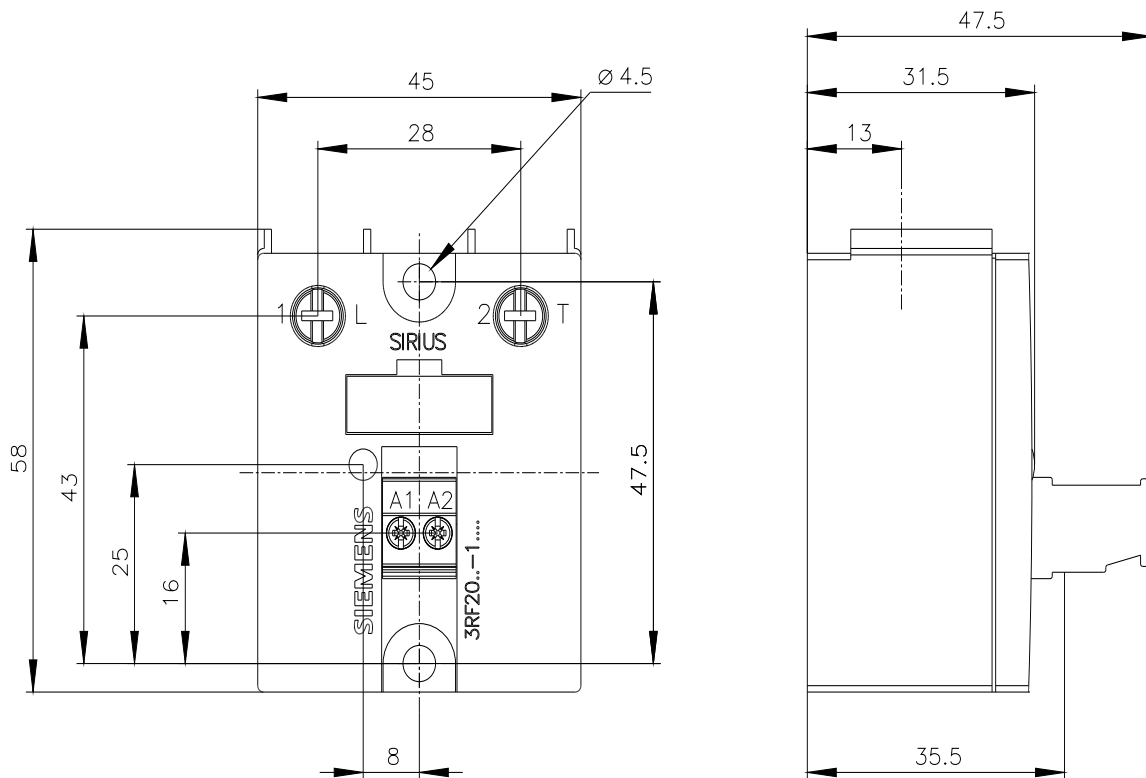

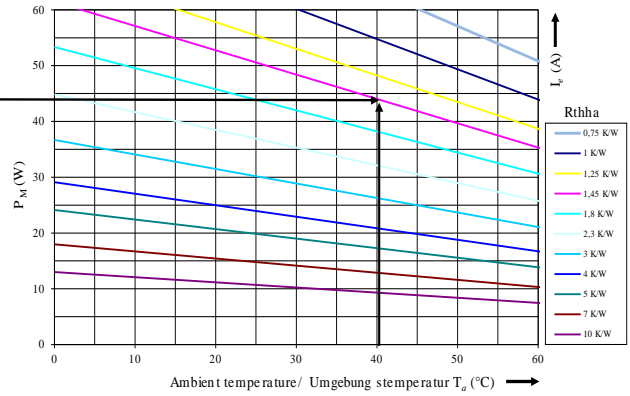
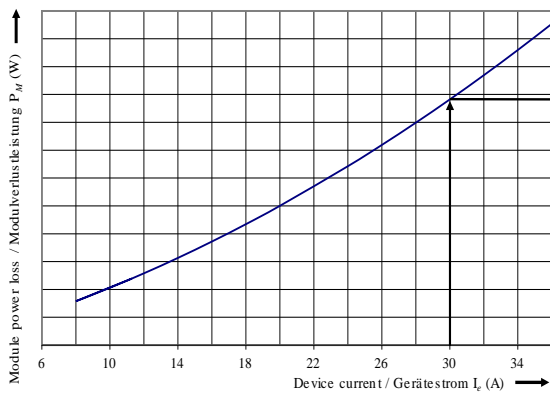

last modified:

4/4/2026