



SIRIUS soft starter 200-600 V 18 A, 24 V AC/DC Screw terminals Thermistor input

product brand name	SIRIUS
product category	Hybrid switching devices
product designation	Soft starter
product type designation	3RW52
manufacturer's article number	
<ul style="list-style-type: none"> of standard HMI module usable of high feature HMI module usable of communication module PROFINET standard usable of communication module PROFIBUS usable of communication module Modbus TCP usable of communication module Modbus RTU usable of communication module Ethernet/IP of circuit breaker usable at 400 V of circuit breaker usable at 500 V of circuit breaker usable at 400 V at inside-delta circuit of circuit breaker usable at 500 V at inside-delta circuit of the gG fuse usable up to 690 V of the gG fuse usable at inside-delta circuit up to 500 V of full range R fuse link for semiconductor protection usable up to 690 V of back-up R fuse link for semiconductor protection usable up to 690 V 	<ul style="list-style-type: none"> 3RW5980-0HS00 3RW5980-0HF00 3RW5980-0CS00 3RW5980-0CP00 3RW5980-0CT00 3RW5980-0CR00 3RW5980-0CE00 3RV2032-4DA10; Type of coordination 1, Iq = 65 kA, CLASS 10 3RV2032-4DA10; Type of coordination 1, Iq = 15 kA, CLASS 10 3RV2032-4EA10; Type of coordination 1, Iq = 65 kA, CLASS 10 3RV2032-4EA10; Type of coordination 1, Iq = 15 kA, CLASS 10 3NA3820-6; Type of coordination 1, Iq = 65 kA 3NA3820-6; Type of coordination 1, Iq = 65 kA 3NE1802-0; Type of coordination 2, Iq = 65 kA 3NE8020-1; Type of coordination 2, Iq = 65 kA











General technical data	
starting voltage [%]	30 ... 100 %
stopping voltage [%]	50 %; non-adjustable
start-up ramp time of soft starter	0 ... 20 s
current limiting value [%] adjustable	130 ... 700 %
certificate of suitability	
<ul style="list-style-type: none"> CE marking UL approval CSA approval 	<ul style="list-style-type: none"> Yes Yes Yes
product component	
<ul style="list-style-type: none"> HMI-High Feature is supported HMI-Standard is supported HMI-High Feature 	<ul style="list-style-type: none"> No Yes Yes
product feature integrated bypass contact system	Yes
number of controlled phases	3

buffering time in the event of power failure	
• for main current circuit	100 ms
• for control circuit	100 ms
insulation voltage rated value	600 V
degree of pollution	3, acc. to IEC 60947-4-2
impulse voltage rated value	6 kV
blocking voltage of the thyristor maximum	1 600 V
service factor	1
surge voltage resistance rated value	6 kV
maximum permissible voltage for protective separation	
• between main and auxiliary circuit	600 V
shock resistance	15 g / 11 ms, from 12 g / 11 ms with potential contact lifting
vibration resistance	15 mm to 6 Hz; 2 g to 500 Hz
utilization category according to IEC 60947-4-2	AC 53a
reference code according to IEC 81346-2	Q
Substance Prohibitance (day/month/year)	02/15/2018
SVHC substance name	Lead CAS-No. 7439-92-1 Lead monoxide (lead oxide) CAS-No. 1317-36-8 2,2',6,6'-tetrabromo-4,4'-isopropylidenediphenol CAS-No. 79-94-7 2-methyl-1-(4-methylthiophenyl)-2-morpholinopropan-1-one CAS-No. 71868-10-5 Melamine CAS-No. 108-78-1 6,6'-di-tert-butyl-2,2'-methylenedi-p-cresol CAS-No. 119-47-1 Dibutylbis(pentane-2,4-dionato-O,O')tin CAS-No. 22673-19-4 Diboron trioxide CAS-No. 1303-86-2
Net Weight	2.3 kg
product function	
• ramp-up (soft starting)	Yes
• soft stopping	Yes
• Soft Torque	Yes
• adjustable current limitation	Yes
• pump stop	Yes
• intrinsic device protection	Yes
• motor overload protection	Yes; Full motor protection (thermistor motor protection and electronic motor overload protection)
• evaluation of thermistor motor protection	Yes; Type A PTC or Klixon / Thermoclick
• inside-delta circuit	Yes
• auto-RESET	Yes
• manual RESET	Yes
• remote reset	Yes; By turning off the control supply voltage
• communication function	Yes
• operating measured value display	Yes; Only in conjunction with special accessories
• error logbook	Yes; Only in conjunction with special accessories
• via software parameterizable	No
• via software configurable	Yes
• PROFInergy	Yes; in connection with the PROFINET Standard communication module
• firmware update	Yes
• removable terminal for control circuit	Yes
• torque control	No
• analog output	No
Power Electronics	
operational current	
• at 40 °C rated value	18 A
• at 50 °C rated value	15.9 A
• at 60 °C rated value	13.8 A
operational current at inside-delta circuit	
• at 40 °C rated value	31.5 A
• at 50 °C rated value	28 A
• at 60 °C rated value	23.9 A
operating voltage	
• rated value	200 ... 600 V

<ul style="list-style-type: none"> • at inside-delta circuit rated value 	200 ... 600 V
relative negative tolerance of the operating voltage	-15 %
relative positive tolerance of the operating voltage	10 %
relative negative tolerance of the operating voltage at inside-delta circuit	-15 %
relative positive tolerance of the operating voltage at inside-delta circuit	10 %
operating power for 3-phase motors	
<ul style="list-style-type: none"> • at 230 V at 40 °C rated value 	4 kW
<ul style="list-style-type: none"> • at 230 V at inside-delta circuit at 40 °C rated value 	7.5 kW
<ul style="list-style-type: none"> • at 400 V at 40 °C rated value 	7.5 kW
<ul style="list-style-type: none"> • at 400 V at inside-delta circuit at 40 °C rated value 	15 kW
<ul style="list-style-type: none"> • at 500 V at 40 °C rated value 	11 kW
<ul style="list-style-type: none"> • at 500 V at inside-delta circuit at 40 °C rated value 	18.5 kW
Operating frequency 1 rated value	50 Hz
Operating frequency 2 rated value	60 Hz
relative negative tolerance of the operating frequency	-10 %
relative positive tolerance of the operating frequency	10 %
adjustable motor current	
<ul style="list-style-type: none"> • at rotary coding switch on switch position 1 	7.5 A
<ul style="list-style-type: none"> • at rotary coding switch on switch position 2 	8.2 A
<ul style="list-style-type: none"> • at rotary coding switch on switch position 3 	8.9 A
<ul style="list-style-type: none"> • at rotary coding switch on switch position 4 	9.6 A
<ul style="list-style-type: none"> • at rotary coding switch on switch position 5 	10.3 A
<ul style="list-style-type: none"> • at rotary coding switch on switch position 6 	11 A
<ul style="list-style-type: none"> • at rotary coding switch on switch position 7 	11.7 A
<ul style="list-style-type: none"> • at rotary coding switch on switch position 8 	12.4 A
<ul style="list-style-type: none"> • at rotary coding switch on switch position 9 	13.1 A
<ul style="list-style-type: none"> • at rotary coding switch on switch position 10 	13.8 A
<ul style="list-style-type: none"> • at rotary coding switch on switch position 11 	14.5 A
<ul style="list-style-type: none"> • at rotary coding switch on switch position 12 	15.2 A
<ul style="list-style-type: none"> • at rotary coding switch on switch position 13 	15.9 A
<ul style="list-style-type: none"> • at rotary coding switch on switch position 14 	16.6 A
<ul style="list-style-type: none"> • at rotary coding switch on switch position 15 	17.3 A
<ul style="list-style-type: none"> • at rotary coding switch on switch position 16 	18 A
<ul style="list-style-type: none"> • minimum 	7.5 A
adjustable motor current	
<ul style="list-style-type: none"> • for inside-delta circuit at rotary coding switch on switch position 1 	13 A
<ul style="list-style-type: none"> • for inside-delta circuit at rotary coding switch on switch position 2 	14.2 A
<ul style="list-style-type: none"> • for inside-delta circuit at rotary coding switch on switch position 3 	15.4 A
<ul style="list-style-type: none"> • for inside-delta circuit at rotary coding switch on switch position 4 	16.6 A
<ul style="list-style-type: none"> • for inside-delta circuit at rotary coding switch on switch position 5 	17.8 A
<ul style="list-style-type: none"> • for inside-delta circuit at rotary coding switch on switch position 6 	19.1 A
<ul style="list-style-type: none"> • for inside-delta circuit at rotary coding switch on switch position 7 	20.3 A
<ul style="list-style-type: none"> • for inside-delta circuit at rotary coding switch on switch position 8 	21.5 A
<ul style="list-style-type: none"> • for inside-delta circuit at rotary coding switch on switch position 9 	22.7 A
<ul style="list-style-type: none"> • for inside-delta circuit at rotary coding switch on switch position 10 	23.9 A
<ul style="list-style-type: none"> • for inside-delta circuit at rotary coding switch on switch position 11 	25.1 A
<ul style="list-style-type: none"> • for inside-delta circuit at rotary coding switch on switch position 12 	26.3 A
<ul style="list-style-type: none"> • for inside-delta circuit at rotary coding switch on switch position 13 	27.5 A

<ul style="list-style-type: none"> • for inside-delta circuit at rotary coding switch on switch position 14 	28.8 A
<ul style="list-style-type: none"> • for inside-delta circuit at rotary coding switch on switch position 15 	30 A
<ul style="list-style-type: none"> • for inside-delta circuit at rotary coding switch on switch position 16 	31.2 A
<ul style="list-style-type: none"> • at inside-delta circuit minimum 	13 A
minimum load [%]	15 %; Relative to smallest settable Ie
power loss [W] for rated value of the current at AC	
<ul style="list-style-type: none"> • at 40 °C after startup 	17 W
<ul style="list-style-type: none"> • at 50 °C after startup 	17 W
<ul style="list-style-type: none"> • at 60 °C after startup 	16 W
power loss [W] at AC at current limitation 350 %	
<ul style="list-style-type: none"> • at 40 °C during startup 	276 W
<ul style="list-style-type: none"> • at 50 °C during startup 	241 W
<ul style="list-style-type: none"> • at 60 °C during startup 	200 W
Control circuit/ Control	
type of voltage of the control supply voltage	AC/DC
control supply voltage at AC	
<ul style="list-style-type: none"> • at 50 Hz rated value 	24 V
<ul style="list-style-type: none"> • at 60 Hz rated value 	24 V
relative negative tolerance of the control supply voltage at AC at 50 Hz	-20 %
relative positive tolerance of the control supply voltage at AC at 50 Hz	20 %
relative negative tolerance of the control supply voltage at AC at 60 Hz	-20 %
relative positive tolerance of the control supply voltage at AC at 60 Hz	20 %
control supply voltage frequency	50 ... 60 Hz
relative negative tolerance of the control supply voltage frequency	-10 %
relative positive tolerance of the control supply voltage frequency	10 %
control supply voltage at DC rated value	24 V
relative negative tolerance of the control supply voltage at DC	-20 %
relative positive tolerance of the control supply voltage at DC	20 %
control supply current in standby mode rated value	160 mA
holding current in bypass operation rated value	360 mA
inrush current by closing the bypass contacts maximum	0.75 A
inrush current peak at application of control supply voltage maximum	3.3 A
duration of inrush current peak at application of control supply voltage	12.1 ms
design of the overvoltage protection	Varistor
design of short-circuit protection for control circuit	4 A gG fuse (Icu=1 kA), 6 A quick-acting fuse (Icu=1 kA), C1 miniature circuit breaker (Icu= 600 A), C6 miniature circuit breaker (Icu= 300 A); Is not part of scope of supply
Inputs/ Outputs	
number of digital inputs	1
number of digital outputs	3
<ul style="list-style-type: none"> • not parameterizable 	2
digital output version	2 normally-open contacts (NO) / 1 changeover contact (CO)
number of analog outputs	0
switching capacity current of the relay outputs	
<ul style="list-style-type: none"> • at AC-15 at 250 V rated value 	3 A
<ul style="list-style-type: none"> • at DC-13 at 24 V rated value 	1 A
Installation/ mounting/ dimensions	
mounting position	+/- 10° rotation possible and can be tilted forward or backward on vertical mounting surface
fastening method	screw fixing

height	275 mm
width	170 mm
depth	152 mm
required spacing with side-by-side mounting	
<ul style="list-style-type: none"> • forwards • backwards • upwards • downwards • at the side 	10 mm 0 mm 100 mm 75 mm 5 mm
weight without packaging	2.1 kg
Connections/ Terminals	
type of electrical connection	
<ul style="list-style-type: none"> • for main current circuit • for control circuit 	screw-type terminals screw-type terminals
wire length for thermistor connection	
<ul style="list-style-type: none"> • with conductor cross-section = 0.5 mm² maximum • with conductor cross-section = 1.5 mm² maximum • with conductor cross-section = 2.5 mm² maximum 	50 m 150 m 250 m
type of connectable conductor cross-sections	
<ul style="list-style-type: none"> • for main contacts <ul style="list-style-type: none"> — solid — finely stranded with core end processing • for AWG cables for main current circuit solid 	2x (1.0 ... 2.5 mm ²), 2x (2.5 ... 10 mm ²) 2x (1.0 ... 2.5 mm ²), 2x (2.5 ... 6.0 mm ²) 2x (16 ... 12), 2x (14 ... 8)
type of connectable conductor cross-sections	
<ul style="list-style-type: none"> • for control circuit solid • for control circuit finely stranded with core end processing • for AWG cables for control circuit solid 	1x (0.5 ... 4.0 mm ²), 2x (0.5 ... 2.5 mm ²) 1x (0.5 ... 2.5 mm ²), 2x (0.5 ... 1.5 mm ²) 1x (20 ... 12), 2x (20 ... 14)
wire length	
<ul style="list-style-type: none"> • between soft starter and motor maximum • at the digital inputs at AC maximum • at the digital inputs at DC maximum 	800 m 100 m 1 000 m
tightening torque	
<ul style="list-style-type: none"> • for main contacts with screw-type terminals • for auxiliary and control contacts with screw-type terminals 	2 ... 2.5 N·m 0.8 ... 1.2 N·m
tightening torque [lbf·in]	
<ul style="list-style-type: none"> • for main contacts with screw-type terminals • for auxiliary and control contacts with screw-type terminals 	18 ... 22 lbf·in 7 ... 10.3 lbf·in
Ambient conditions	
installation altitude at height above sea level maximum	5 000 m
ambient temperature	
<ul style="list-style-type: none"> • during operation • during storage and transport 	-25 ... +60 °C; Please observe derating at temperatures of 40 °C or above -40 ... +80 °C
environmental category	
<ul style="list-style-type: none"> • during operation according to IEC 60721 • during storage according to IEC 60721 • during transport according to IEC 60721 	3K6 (no ice formation, only occasional condensation), 3C3 (no salt mist), 3S2 (sand must not get into the devices), 3M6 1K6 (only occasional condensation), 1C2 (no salt mist), 1S2 (sand must not get inside the devices), 1M4 2K2, 2C1, 2S1, 2M2 (max. fall height 0.3 m)
Electromagnetic compatibility	
EMC emitted interference	acc. to IEC 60947-4-2: Class A
Communication/ Protocol	
communication module is supported	
<ul style="list-style-type: none"> • PROFINET standard • EtherNet/IP • Modbus RTU • Modbus TCP • PROFIBUS 	Yes Yes Yes Yes Yes
UL/CSA ratings	

manufacturer's article number			
<ul style="list-style-type: none"> ● of circuit breaker usable for Standard Faults <ul style="list-style-type: none"> — at 460/480 V according to UL — 60/480 V according to UL — at 460/480 V at inside-delta circuit according to UL — 60/480 V at inside-delta circuit according to UL — at 575/600 V according to UL — at 575/600 V at inside-delta circuit according to UL ● of the fuse <ul style="list-style-type: none"> — usable for Standard Faults up to 575/600 V according to UL — usable for High Faults up to 575/600 V according to UL — usable for Standard Faults at inside-delta circuit up to 575/600 V according to UL — usable for High Faults at inside-delta circuit up to 575/600 V according to UL 	<p>Siemens type: 3RV2742, max. 60 A or 3VA51, max. 60 A; Iq = 5 kA Siemens type: 3RV2742, max. 30 A or 3VA51, max. 35 A; Iq max = 65 kA Siemens type: 3RV2742, max. 60 A or 3VA51, max. 60 A; Iq = 5 kA Siemens type: 3VA51, max. 35 A; Iq max = 65 kA Siemens type: 3RV2742, max. 60 A or 3VA51, max. 60 A; Iq = 5 kA Siemens type: 3RV2742, max. 60 A or 3VA51, max. 60 A; Iq = 5 kA</p> <p>Type: Class RK5 / K5, max. 70 A; Iq = 5 kA</p> <p>Type: Class J / L, max. 70 A; Iq = 100 kA</p> <p>Type: Class RK5 / K5, max. 70 A; Iq = 5 kA</p> <p>Type: Class J / L, max. 70 A; Iq = 100 kA</p>		
operating power [hp] for 3-phase motors			
<ul style="list-style-type: none"> ● at 200/208 V at 50 °C rated value ● at 220/230 V at 50 °C rated value ● at 460/480 V at 50 °C rated value ● at 575/600 V at 50 °C rated value ● at 200/208 V at inside-delta circuit at 50 °C rated value ● at 220/230 V at inside-delta circuit at 50 °C rated value ● at 460/480 V at inside-delta circuit at 50 °C rated value ● at 575/600 V at inside-delta circuit at 50 °C rated value 	<p>3 hp 5 hp 10 hp 10 hp 7.5 hp 7.5 hp 20 hp 25 hp</p>		
contact rating of auxiliary contacts according to UL	R300-B300		
Electrical Safety			
protection class IP on the front according to IEC 60529	IP20		
touch protection on the front according to IEC 60529	finger-safe, for vertical contact from the front		
Approvals Certificates			
Environmental Product Declaration			
<ul style="list-style-type: none"> ● global warming potential [CO2 eq] / during manufacturing ● global warming potential [CO2 eq] / during sales ● global warming potential [CO2 eq] / during operation ● global warming potential [CO2 eq] / after end of life ● global warming potential [CO2 eq] / total 	<p>37.2 kg 0.66 kg 152 kg -4.19 kg 185 kg</p>		
Environment	General Product Approval		
Environmental Confirmations     			
General Product Approval	EMV	Test Certificates	Maritime application
   		Type Test Certificates/Test Report	
Maritime application	other		
   	Confirmation	Confirmation	
other			



Further information

Information on the packaging

<https://support.industry.siemens.com/cs/ww/en/view/109813875>

Information for data generation and storage

<https://support.industry.siemens.com/cs/ww/en/view/109995012>

Information- and Downloadcenter (Catalogs, Brochures,...)

<https://www.siemens.com/ic10>

Industry Mall (Online ordering system)

<https://mall.industry.siemens.com/mall/en/en/Catalog/product?mlfb=3RW5214-1TC05>

Service&Support (Manuals, Certificates, Characteristics, FAQs,...)

<https://support.industry.siemens.com/cs/ww/en/ps/3RW5214-1TC05>

Image database (product images, 2D dimension drawings, 3D models, device circuit diagrams, EPLAN macros, ...)

https://www.automation.siemens.com/bilddb/cax_de.aspx?mlfb=3RW5214-1TC05&lang=en

Cax online generator

<https://support.automation.siemens.com/WW/CAXorder/default.aspx?lang=en&mlfb=3RW5214-1TC05>

Characteristic curves

[https://curves.simaris.siemens.com/curves/<mmp_prod_noCOMP="HAUPT"></mmp_prod_no>](https://curves.simaris.siemens.com/curves/<mmp_prod_noCOMP=)

Characteristic: Tripping characteristics, I²t, Let-through current

<https://support.industry.siemens.com/cs/ww/en/ps/3RW5214-1TC05/char>

Characteristic: Installation altitude

https://www.automation.siemens.com/bilddb/index.aspx?gridview=view2&objkey=G_NSB0_XX_01704&showdetail=true&view=Search

Simulation Tool for Soft Starters (STS)

<https://support.industry.siemens.com/cs/ww/en/view/101494917>

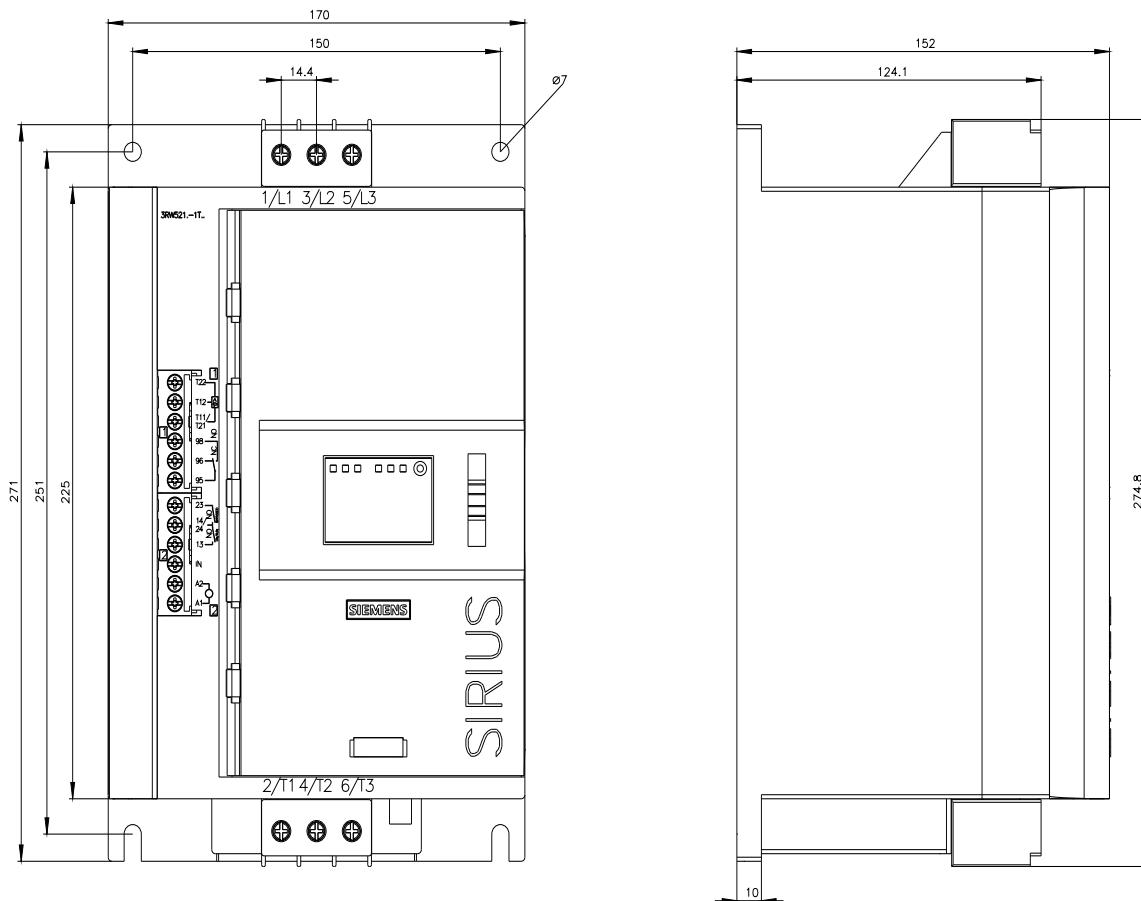

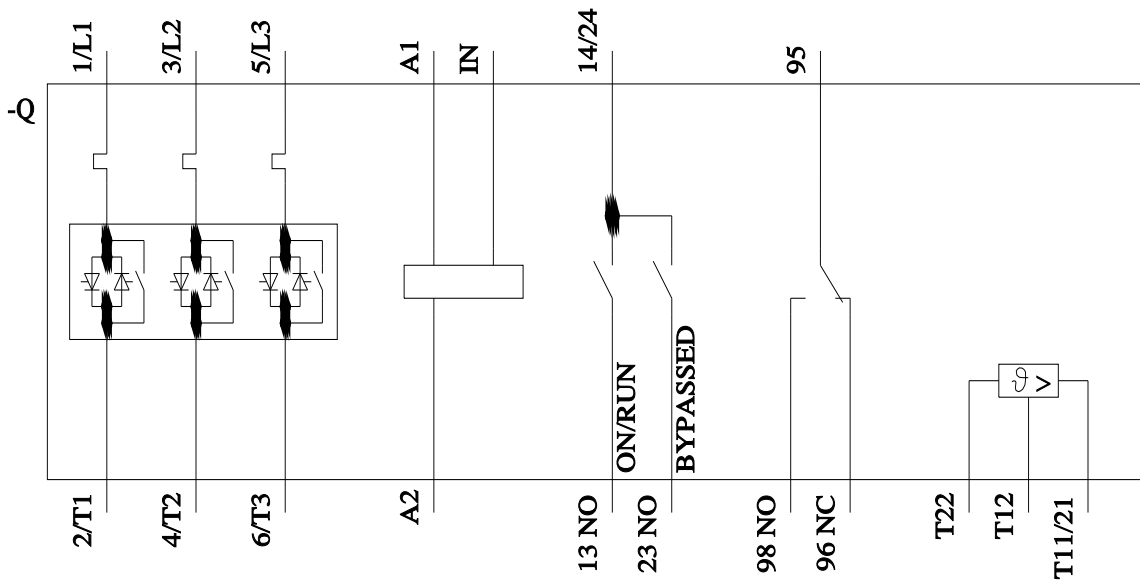

last modified:

4/4/2026 

