



circuit breaker size S2 for motor protection, Class 20 thermal release 42...52 A short-circuit release 741 A screw terminal standard switching capacity with transverse auxiliary switch 1 NO+1 NC

product brand name	SIRIUS
product designation	Circuit breaker
design of the product	For motor protection
product type designation	3RV2
<b>General technical data</b>	
Product equipment of circuit breaker for motor protection complete unit with protection device	Yes
size of the circuit-breaker	S2
size of contactor can be combined company-specific	S2
product function disconnecter functionality	Yes
product extension auxiliary switch	Yes
power loss [W] for rated value of the current	
• at AC in hot operating state	24.5 W
• at AC in hot operating state per pole	8.2 W
type of calculation of power loss current-dependent	quadratic
insulation voltage with degree of pollution 3 at AC rated value	690 V
surge voltage resistance rated value	6 kV
maximum permissible voltage for protective separation	
• in networks with ungrounded star point between main and auxiliary circuit	400 V
• in networks with grounded star point between main and auxiliary circuit	400 V
protection class IP	
• on the front according to IEC 60529	IP20
• on the front	IP20
• of the terminal	IP00
shock resistance according to IEC 60068-2-27	25 g / 11 ms Sinus
mechanical service life (operating cycles)	
• of the main contacts typical	50 000
• of auxiliary contacts typical	50 000
electrical endurance (operating cycles) typical	50 000
reference code according to IEC 81346-2	Q
continuous current rated value	52 A
Substance Prohibitance (day/month/year)	10/15/2014
SVHC substance name	Lead CAS-No. 7439-92-1
Net Weight	1.22 kg
<b>Ambient conditions</b>	















installation altitude at height above sea level maximum	2 000 m
<b>ambient temperature</b>	
• during operation	-20 ... +60 °C
• during storage	-50 ... +80 °C
• during transport	-50 ... +80 °C
<b>temperature compensation</b>	-20 ... +60 °C
relative humidity during operation	10 ... 95 %
<b>Main circuit</b>	
<b>number of poles for main current circuit</b>	3
<b>adjustable current response value current of the current-dependent overload release</b>	42 ... 52 A
<b>type of voltage for main current circuit</b>	AC
<b>operating voltage</b>	
• rated value	690 V
• rated value	20 ... 690 V
• at AC-3 rated value maximum	690 V
• at AC-3e rated value maximum	690 V
<b>operating frequency rated value</b>	50 ... 60 Hz
<b>operational current rated value</b>	52 A
<b>operational current</b>	
• at AC-3 at 400 V rated value	52 A
• at AC-3e at 400 V rated value	52 A
<b>operating power</b>	
• at AC-3	
— at 230 V rated value	15 kW
— at 400 V rated value	22 kW
— at 500 V rated value	30 kW
— at 690 V rated value	45 kW
• at AC-3e	
— at 230 V rated value	15 kW
— at 400 V rated value	22 kW
— at 500 V rated value	30 kW
— at 690 V rated value	45 kW
<b>operating frequency</b>	
• at AC-3 maximum	15 1/h
• at AC-3e maximum	15 1/h
<b>Auxiliary circuit</b>	
<b>design of the auxiliary switch</b>	transverse
<b>type of voltage for auxiliary and control circuit</b>	AC/DC
<b>number of NC contacts for auxiliary contacts</b>	1
<b>number of NO contacts for auxiliary contacts</b>	1
number of CO contacts for auxiliary contacts	0
<b>operational current of auxiliary contacts at AC-15</b>	
• at 24 V	2 A
• at 230 V	0.5 A
<b>operational current of auxiliary contacts at DC-13</b>	
• at 24 V	1 A
• at 60 V	0.15 A
• at 110 V	0 A
• at 125 V	0 A
• at 220 V	0 A
<b>Protective and monitoring functions</b>	
<b>product function</b>	
• ground fault detection	No
• phase failure detection	Yes
<b>trip class</b>	CLASS 20
<b>design of the overload release</b>	thermal
<b>protection function thermal overload protection (ANSI 49)</b>	Yes
<b>maximum short-circuit current breaking capacity (Icu)</b>	

<ul style="list-style-type: none"> <li>• at AC at 240 V rated value</li> <li>• at AC at 400 V rated value</li> <li>• at AC at 500 V rated value</li> <li>• at AC at 690 V rated value</li> </ul>	100 kA 65 kA 8 kA 4 kA
<b>operating short-circuit current breaking capacity (Ics) at AC</b>	
<ul style="list-style-type: none"> <li>• at 240 V rated value</li> <li>• at 400 V rated value</li> <li>• at 500 V rated value</li> <li>• at 690 V rated value</li> </ul>	100 kA 30 kA 4 kA 2 kA
response value current of instantaneous short-circuit trip unit	741 A
<b>UL/CSA ratings</b>	
<b>full-load current (FLA) for 3-phase AC motor</b>	
<ul style="list-style-type: none"> <li>• at 480 V rated value</li> <li>• at 600 V rated value</li> </ul>	52 A 52 A
<b>yielded mechanical performance [hp]</b>	
<ul style="list-style-type: none"> <li>• for single-phase AC motor               <ul style="list-style-type: none"> <li>— at 110/120 V rated value</li> <li>— at 230 V rated value</li> </ul> </li> <li>• for 3-phase AC motor               <ul style="list-style-type: none"> <li>— at 200/208 V rated value</li> <li>— at 220/230 V rated value</li> <li>— at 460/480 V rated value</li> <li>— at 575/600 V rated value</li> </ul> </li> </ul>	5 hp 10 hp  15 hp 20 hp 40 hp 50 hp
<b>contact rating of auxiliary contacts according to UL</b>	C300 / R300
<b>Short-circuit protection</b>	
<b>product function short circuit protection</b>	Yes
<b>design of the short-circuit trip</b>	magnetic
<b>design of the fuse link</b>	
<ul style="list-style-type: none"> <li>• for short-circuit protection of the auxiliary switch required</li> </ul>	fuse gG: 10 A, miniature circuit breaker C 6 A (short-circuit current I <sub>k</sub> < 400 A)
<b>design of the fuse link for IT network for short-circuit protection of the main circuit</b>	
<ul style="list-style-type: none"> <li>• at 240 V</li> <li>• at 400 V</li> <li>• at 500 V</li> <li>• at 690 V</li> </ul>	none required 160 125 100
<b>Installation/ mounting/ dimensions</b>	
<b>mounting position</b>	any
<b>fastening method</b>	screw and snap-on mounting onto 35 mm DIN rail according to DIN EN 60715
<b>Mounting method of circuit breaker for Transformer protection, Generator protection and system protection optional standard bar mounting</b>	Yes
<b>height</b>	140 mm
<b>width</b>	55 mm
<b>depth</b>	149 mm
<b>required spacing</b>	
<ul style="list-style-type: none"> <li>• with side-by-side mounting               <ul style="list-style-type: none"> <li>— forwards</li> <li>— backwards</li> <li>— upwards</li> <li>— downwards</li> <li>— at the side</li> </ul> </li> <li>• for grounded parts               <ul style="list-style-type: none"> <li>— forwards</li> <li>— backwards</li> <li>— upwards</li> <li>— at the side</li> <li>— downwards</li> </ul> </li> <li>• for live parts               <ul style="list-style-type: none"> <li>— forwards</li> <li>— backwards</li> </ul> </li> </ul>	0 mm 0 mm 50 mm 50 mm 0 mm  0 mm 0 mm 50 mm 10 mm 50 mm  0 mm 0 mm

— upwards	50 mm
— downwards	50 mm
— at the side	10 mm
● for grounded parts at 400 V	
— downwards	50 mm
— upwards	50 mm
— at the side	10 mm
● for live parts at 400 V	
— downwards	50 mm
— upwards	50 mm
— at the side	10 mm
● for grounded parts at 500 V	
— downwards	50 mm
— upwards	50 mm
— at the side	10 mm
● for live parts at 500 V	
— downwards	50 mm
— upwards	50 mm
— at the side	10 mm
● for grounded parts at 690 V	
— downwards	50 mm
— upwards	50 mm
— at the side	10 mm
● for live parts at 690 V	
— downwards	50 mm
— upwards	50 mm
— at the side	10 mm

#### Connections/ Terminals

<b>product component removable terminal for auxiliary and control circuit</b>	No
<b>type of electrical connection</b>	
● for main current circuit	screw-type terminals
● for auxiliary and control circuit	screw-type terminals
<b>arrangement of electrical connectors for main current circuit</b>	Top and bottom
<b>type of connectable conductor cross-sections</b>	
● for main contacts	
— solid or stranded	2x (1 ... 35 mm <sup>2</sup> ), 1x (1 ... 50 mm <sup>2</sup> )
— finely stranded with core end processing	2x (1 ... 25 mm <sup>2</sup> ), 1x (1 ... 35 mm <sup>2</sup> )
● for AWG cables for main contacts	2x (18 ... 2), 1x (18 ... 1)
<b>connectable conductor cross-section for main contacts</b>	
● solid or stranded	1 ... 50 mm <sup>2</sup>
● finely stranded with core end processing	1 ... 35 mm <sup>2</sup>
<b>connectable conductor cross-section for auxiliary contacts</b>	
● solid or stranded	0.5 ... 2.5 mm <sup>2</sup>
● finely stranded with core end processing	0.5 ... 2.5 mm <sup>2</sup>
<b>type of connectable conductor cross-sections</b>	
● for auxiliary contacts	
— solid or stranded	2x (0.5 ... 1.5 mm <sup>2</sup> ), 2x (0.75 ... 2.5 mm <sup>2</sup> )
— finely stranded with core end processing	2x (0.5 ... 1.5 mm <sup>2</sup> ), 2x (0.75 ... 2.5 mm <sup>2</sup> )
● for AWG cables for auxiliary contacts	2x (20 ... 16), 2x (18 ... 14)
<b>AWG number as coded connectable conductor cross section for main contacts</b>	18 ... 1
<b>AWG number as coded connectable conductor cross section for auxiliary contacts</b>	20 ... 14
<b>tightening torque</b>	
● for main contacts with screw-type terminals	3 ... 4.5 N·m
● for auxiliary contacts with screw-type terminals	0.8 ... 1.2 N·m
<b>design of screwdriver shaft</b>	Diameter 5 to 6 mm
<b>size of the screwdriver tip</b>	Pozidriv size 2

<b>design of the thread of the connection screw</b>	
<ul style="list-style-type: none"> <li>• for main contacts</li> <li>• of the auxiliary and control contacts</li> </ul>	<p>M6</p> <p>M3</p>
<b>Safety related data</b>	
product function suitable for safety function	Yes
<b>suitability for use</b>	
<ul style="list-style-type: none"> <li>• safety-related switching on</li> <li>• safety-related switching OFF</li> </ul>	<p>No</p> <p>Yes</p>
<b>service life maximum</b>	10 a
<b>test wear-related service life necessary</b>	Yes
<b>proportion of dangerous failures</b>	
<ul style="list-style-type: none"> <li>• with low demand rate according to SN 31920</li> <li>• with high demand rate according to SN 31920</li> </ul>	<p>40 %</p> <p>50 %</p>
<b>B10 value with high demand rate according to SN 31920</b>	5 000
<b>failure rate [FIT] with low demand rate according to SN 31920</b>	50 FIT
<b>ISO 13849</b>	
<b>device type according to ISO 13849-1</b>	3
<b>overdimensioning according to ISO 13849-2 necessary</b>	Yes
<b>IEC 61508</b>	
<b>safety device type according to IEC 61508-2</b>	Type A
<b>T1 value</b>	
<ul style="list-style-type: none"> <li>• for proof test interval or service life according to IEC 61508</li> </ul>	10 a
<b>Electrical Safety</b>	
<b>protection class IP on the front according to IEC 60529</b>	IP20
<b>touch protection on the front according to IEC 60529</b>	finger-safe, for vertical contact from the front
<b>Display</b>	
display version for switching status	Handle
<b>Approvals Certificates</b>	
<b>Environmental Product Declaration</b>	
<ul style="list-style-type: none"> <li>• global warming potential [CO2 eq] / during manufacturing</li> <li>• global warming potential [CO2 eq] / during sales</li> <li>• global warming potential [CO2 eq] / during operation</li> <li>• global warming potential [CO2 eq] / after end of life</li> <li>• global warming potential [CO2 eq] / total</li> </ul>	<p>12.8 kg</p> <p>0.477 kg</p> <p>230 kg</p> <p>-3.4 kg</p> <p>239.877 kg</p>
<b>Environment</b>	<b>General Product Approval</b>
<a href="#">Environmental Confirmations</a>	    
<b>General Product Approval</b>	<b>Test Certificates</b>
    	<a href="#">Special Test Certificate</a>
<b>Test Certificates</b>	<b>Maritime application</b>
<a href="#">Type Test Certificates/Test Report</a>	    
<b>Maritime application</b>	<b>other</b>



[Confirmation](#)

[Miscellaneous](#)

[Confirmation](#)

[Miscellaneous](#)



## Railway

[Confirmation](#)

[Special Test Certificate](#)

## Further information

### Information on the packaging

<https://support.industry.siemens.com/cs/ww/en/view/109813875>

### Information for data generation and storage

<https://support.industry.siemens.com/cs/ww/en/view/109995012>

### Information- and Downloadcenter (Catalogs, Brochures,...)

<https://www.siemens.com/ic10>

### Industry Mall (Online ordering system)

<https://mall.industry.siemens.com/mall/en/en/Catalog/product?mlfb=3RV2031-4WB15>

### Service&Support (Manuals, Certificates, Characteristics, FAQs,...)

<https://support.industry.siemens.com/cs/ww/en/ps/3RV2031-4WB15>

### Image database (product images, 2D dimension drawings, 3D models, device circuit diagrams, EPLAN macros, ...)

[https://www.automation.siemens.com/bilddb/cax\\_de.aspx?mlfb=3RV2031-4WB15&lang=en](https://www.automation.siemens.com/bilddb/cax_de.aspx?mlfb=3RV2031-4WB15&lang=en)

### Cax online generator

<https://support.automation.siemens.com/WW/CAXorder/default.aspx?lang=en&mlfb=3RV2031-4WB15>

### Characteristic curves

[https://curves.simaris.siemens.com/curves/<mmp\\_prod\\_noCOMP="HAUPT"></mmp\\_prod\\_no>](https://curves.simaris.siemens.com/curves/<mmp_prod_noCOMP=)



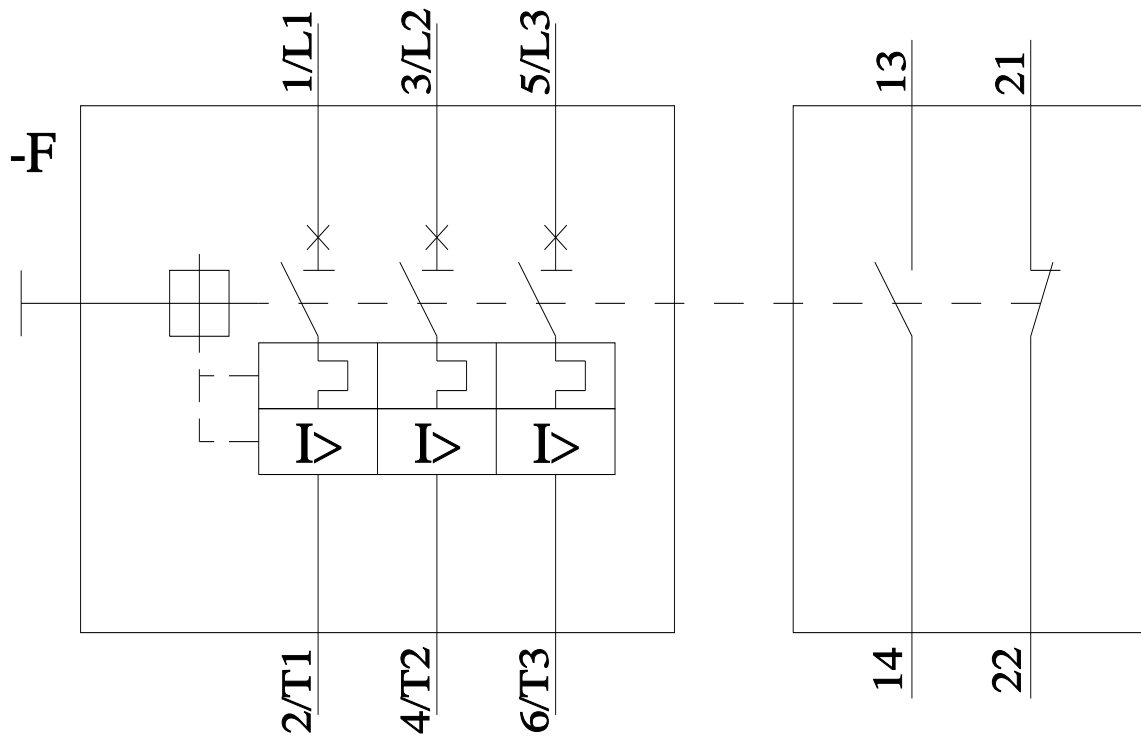

last modified:

5/5/2026 