



circuit breaker size S2 for motor protection, Class 20 thermal release 18...25 A short-circuit release 325 A screw terminal standard switching capacity with transverse auxiliary switch 1 NO+1 NC

product brand name	SIRIUS
product designation	Circuit breaker
design of the product	For motor protection
product type designation	3RV2
General technical data	
Product equipment of circuit breaker for motor protection complete unit with protection device	Yes
size of the circuit-breaker	S2
size of contactor can be combined company-specific	S2
product function disconnecter functionality	Yes
product extension auxiliary switch	Yes
power loss [W] for rated value of the current	
• at AC in hot operating state	14.5 W
• at AC in hot operating state per pole	4.8 W
type of calculation of power loss current-dependent	quadratic
insulation voltage with degree of pollution 3 at AC rated value	690 V
surge voltage resistance rated value	6 kV
maximum permissible voltage for protective separation	
• in networks with ungrounded star point between main and auxiliary circuit	400 V
• in networks with grounded star point between main and auxiliary circuit	400 V
protection class IP	
• on the front according to IEC 60529	IP20
• on the front	IP20
• of the terminal	IP00
shock resistance according to IEC 60068-2-27	25 g / 11 ms Sinus
mechanical service life (operating cycles)	
• of the main contacts typical	50 000
• of auxiliary contacts typical	50 000
electrical endurance (operating cycles) typical	50 000
reference code according to IEC 81346-2	Q
continuous current rated value	25 A
Substance Prohibitance (day/month/year)	10/15/2014
SVHC substance name	Lead CAS-No. 7439-92-1
Net Weight	1.088 kg
Ambient conditions	















installation altitude at height above sea level maximum	2 000 m
ambient temperature	
• during operation	-20 ... +60 °C
• during storage	-50 ... +80 °C
• during transport	-50 ... +80 °C
temperature compensation	-20 ... +60 °C
relative humidity during operation	10 ... 95 %
Main circuit	
number of poles for main current circuit	3
adjustable current response value current of the current-dependent overload release	18 ... 25 A
type of voltage for main current circuit	AC
operating voltage	
• rated value	690 V
• rated value	20 ... 690 V
• at AC-3 rated value maximum	690 V
• at AC-3e rated value maximum	690 V
operating frequency rated value	50 ... 60 Hz
operational current rated value	25 A
operational current	
• at AC-3 at 400 V rated value	25 A
• at AC-3e at 400 V rated value	25 A
operating power	
• at AC-3	
— at 230 V rated value	5.5 kW
— at 400 V rated value	11 kW
— at 500 V rated value	15 kW
— at 690 V rated value	22 kW
• at AC-3e	
— at 230 V rated value	5.5 kW
— at 400 V rated value	11 kW
— at 500 V rated value	15 kW
— at 690 V rated value	22 kW
operating frequency	
• at AC-3 maximum	15 1/h
• at AC-3e maximum	15 1/h
Auxiliary circuit	
design of the auxiliary switch	transverse
type of voltage for auxiliary and control circuit	AC/DC
number of NC contacts for auxiliary contacts	1
number of NO contacts for auxiliary contacts	1
number of CO contacts for auxiliary contacts	0
operational current of auxiliary contacts at AC-15	
• at 24 V	2 A
• at 230 V	0.5 A
operational current of auxiliary contacts at DC-13	
• at 24 V	1 A
• at 60 V	0.15 A
• at 110 V	0 A
• at 125 V	0 A
• at 220 V	0 A
Protective and monitoring functions	
product function	
• ground fault detection	No
• phase failure detection	Yes
trip class	CLASS 20
design of the overload release	thermal
protection function thermal overload protection (ANSI 49)	Yes
maximum short-circuit current breaking capacity (Icu)	

<ul style="list-style-type: none"> • at AC at 240 V rated value • at AC at 400 V rated value • at AC at 500 V rated value • at AC at 690 V rated value 	<p>100 kA</p> <p>65 kA</p> <p>12 kA</p> <p>5 kA</p>
operating short-circuit current breaking capacity (Ics) at AC <ul style="list-style-type: none"> • at 240 V rated value • at 400 V rated value • at 500 V rated value • at 690 V rated value 	<p>100 kA</p> <p>30 kA</p> <p>6 kA</p> <p>3 kA</p>
response value current of instantaneous short-circuit trip unit	325 A
UL/CSA ratings	
full-load current (FLA) for 3-phase AC motor <ul style="list-style-type: none"> • at 480 V rated value • at 600 V rated value 	<p>25 A</p> <p>25 A</p>
yielded mechanical performance [hp] <ul style="list-style-type: none"> • for single-phase AC motor <ul style="list-style-type: none"> — at 110/120 V rated value — at 230 V rated value • for 3-phase AC motor <ul style="list-style-type: none"> — at 200/208 V rated value — at 220/230 V rated value — at 460/480 V rated value — at 575/600 V rated value 	<p>2 hp</p> <p>5 hp</p> <p>7.5 hp</p> <p>10 hp</p> <p>20 hp</p> <p>25 hp</p>
contact rating of auxiliary contacts according to UL	C300 / R300
Short-circuit protection	
product function short circuit protection	Yes
design of the short-circuit trip	magnetic
design of the fuse link <ul style="list-style-type: none"> • for short-circuit protection of the auxiliary switch required 	fuse gG: 10 A, miniature circuit breaker C 6 A (short-circuit current I _k < 400 A)
design of the fuse link for IT network for short-circuit protection of the main circuit <ul style="list-style-type: none"> • at 240 V • at 400 V • at 500 V • at 690 V 	<p>none required</p> <p>100</p> <p>80</p> <p>63</p>
Installation/ mounting/ dimensions	
mounting position	any
fastening method	screw and snap-on mounting onto 35 mm DIN rail according to DIN EN 60715
Mounting method of circuit breaker for Transformer protection, Generator protection and system protection optional standard bar mounting	Yes
height	140 mm
width	55 mm
depth	149 mm
required spacing <ul style="list-style-type: none"> • with side-by-side mounting <ul style="list-style-type: none"> — forwards — backwards — upwards — downwards — at the side • for grounded parts <ul style="list-style-type: none"> — forwards — backwards — upwards — at the side — downwards • for live parts <ul style="list-style-type: none"> — forwards — backwards 	<p>0 mm</p> <p>0 mm</p> <p>50 mm</p> <p>50 mm</p> <p>0 mm</p> <p>0 mm</p> <p>0 mm</p> <p>50 mm</p> <p>10 mm</p> <p>50 mm</p> <p>0 mm</p> <p>0 mm</p>

— upwards	50 mm
— downwards	50 mm
— at the side	10 mm
● for grounded parts at 400 V	
— downwards	50 mm
— upwards	50 mm
— at the side	10 mm
● for live parts at 400 V	
— downwards	50 mm
— upwards	50 mm
— at the side	10 mm
● for grounded parts at 500 V	
— downwards	50 mm
— upwards	50 mm
— at the side	10 mm
● for live parts at 500 V	
— downwards	50 mm
— upwards	50 mm
— at the side	10 mm
● for grounded parts at 690 V	
— downwards	50 mm
— upwards	50 mm
— at the side	10 mm
● for live parts at 690 V	
— downwards	50 mm
— upwards	50 mm
— at the side	10 mm

Connections/ Terminals

product component removable terminal for auxiliary and control circuit	No
type of electrical connection	
● for main current circuit	screw-type terminals
● for auxiliary and control circuit	screw-type terminals
arrangement of electrical connectors for main current circuit	Top and bottom
type of connectable conductor cross-sections	
● for main contacts	
— solid or stranded	2x (1 ... 25 mm ²), 1x (1 ... 35 mm ²)
— finely stranded with core end processing	2x (1 ... 16 mm ²), 1x (1 ... 25 mm ²)
● for AWG cables for main contacts	2x (18 ... 3), 1x (18 ... 2)
connectable conductor cross-section for main contacts	
● solid or stranded	1 ... 35 mm ²
● finely stranded with core end processing	1 ... 25 mm ²
connectable conductor cross-section for auxiliary contacts	
● solid or stranded	0.5 ... 2.5 mm ²
● finely stranded with core end processing	0.5 ... 2.5 mm ²
type of connectable conductor cross-sections	
● for auxiliary contacts	
— solid or stranded	2x (0.5 ... 1.5 mm ²), 2x (0.75 ... 2.5 mm ²)
— finely stranded with core end processing	2x (0.5 ... 1.5 mm ²), 2x (0.75 ... 2.5 mm ²)
● for AWG cables for auxiliary contacts	2x (20 ... 16), 2x (18 ... 14)
AWG number as coded connectable conductor cross section for main contacts	18 ... 2
AWG number as coded connectable conductor cross section for auxiliary contacts	20 ... 14
tightening torque	
● for main contacts with screw-type terminals	3 ... 4.5 N·m
● for auxiliary contacts with screw-type terminals	0.8 ... 1.2 N·m
design of screwdriver shaft	Diameter 5 to 6 mm
size of the screwdriver tip	Pozidriv size 2

design of the thread of the connection screw	
<ul style="list-style-type: none"> • for main contacts • of the auxiliary and control contacts 	<p>M6</p> <p>M3</p>
Safety related data	
product function suitable for safety function	Yes
suitability for use	
<ul style="list-style-type: none"> • safety-related switching on • safety-related switching OFF 	<p>No</p> <p>Yes</p>
service life maximum	10 a
test wear-related service life necessary	Yes
proportion of dangerous failures	
<ul style="list-style-type: none"> • with low demand rate according to SN 31920 • with high demand rate according to SN 31920 	<p>40 %</p> <p>50 %</p>
B10 value with high demand rate according to SN 31920	5 000
failure rate [FIT] with low demand rate according to SN 31920	50 FIT
ISO 13849	
device type according to ISO 13849-1	3
overdimensioning according to ISO 13849-2 necessary	Yes
IEC 61508	
safety device type according to IEC 61508-2	Type A
T1 value	
<ul style="list-style-type: none"> • for proof test interval or service life according to IEC 61508 	10 a
Electrical Safety	
protection class IP on the front according to IEC 60529	IP20
touch protection on the front according to IEC 60529	finger-safe, for vertical contact from the front
Display	
display version for switching status	Handle
Approvals Certificates	
Environmental Product Declaration	
<ul style="list-style-type: none"> • global warming potential [CO2 eq] / during manufacturing • global warming potential [CO2 eq] / during sales • global warming potential [CO2 eq] / during operation • global warming potential [CO2 eq] / after end of life • global warming potential [CO2 eq] / total 	<p>12.8 kg</p> <p>0.477 kg</p> <p>230 kg</p> <p>-3.4 kg</p> <p>239.877 kg</p>
Environment	General Product Approval
Environmental Confirmations	    
General Product Approval	Test Certificates
    	Special Test Certificate
Test Certificates	Maritime application
Type Test Certificates/Test Report	    
Maritime application	other



[Confirmation](#)

[Miscellaneous](#)

[Confirmation](#)

[Miscellaneous](#)



Railway

[Confirmation](#)

[Special Test Certificate](#)

Further information

Information on the packaging

<https://support.industry.siemens.com/cs/ww/en/view/109813875>

Information for data generation and storage

<https://support.industry.siemens.com/cs/ww/en/view/109995012>

Information- and Downloadcenter (Catalogs, Brochures,...)

<https://www.siemens.com/ic10>

Industry Mall (Online ordering system)

<https://mall.industry.siemens.com/mall/en/en/Catalog/product?mlfb=3RV2031-4DB15>

Service&Support (Manuals, Certificates, Characteristics, FAQs,...)

<https://support.industry.siemens.com/cs/ww/en/ps/3RV2031-4DB15>

Image database (product images, 2D dimension drawings, 3D models, device circuit diagrams, EPLAN macros, ...)

https://www.automation.siemens.com/bilddb/cax_de.aspx?mlfb=3RV2031-4DB15&lang=en

Cax online generator

<https://support.automation.siemens.com/WW/CAXorder/default.aspx?lang=en&mlfb=3RV2031-4DB15>

Characteristic curves

[https://curves.simaris.siemens.com/curves/<mmp_prod_noCOMP="HAUPT"></mmp_prod_no>](https://curves.simaris.siemens.com/curves/<mmp_prod_noCOMP=)



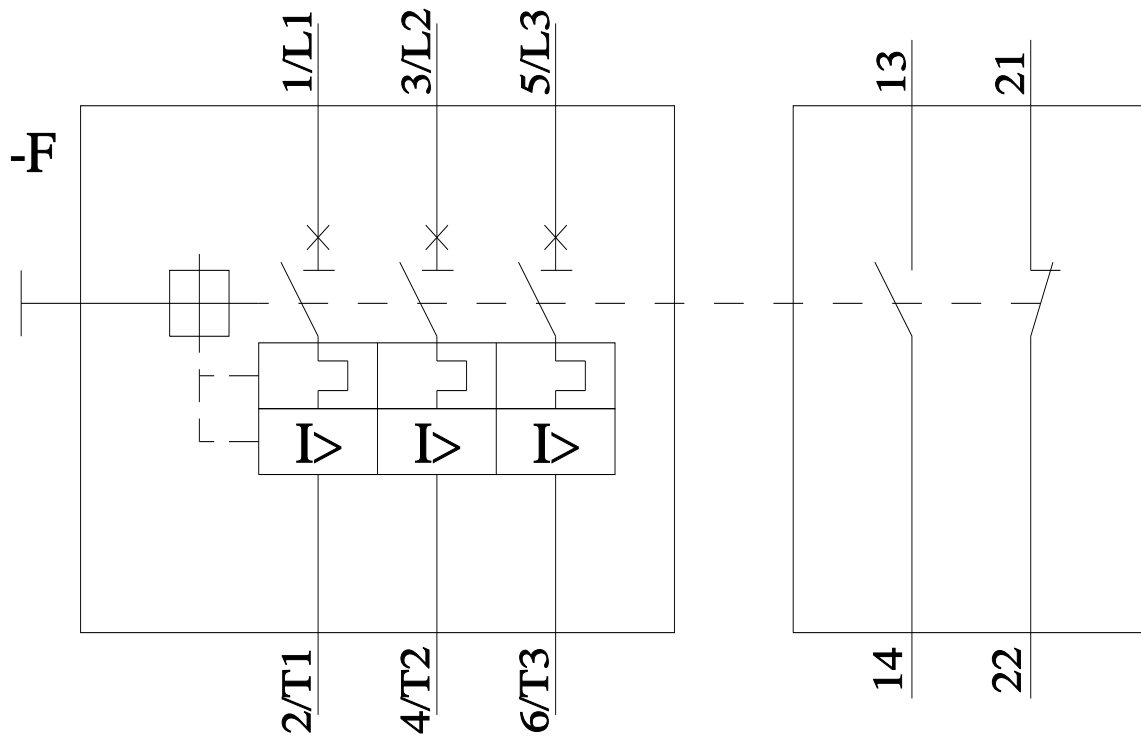

last modified:

5/5/2026 