





















circuit breaker frame size S0 for motor protection, Class 10 thermal release 0.45...0.63 A short-circuit release 8.2 A screw terminal standard switching capacity with transverse auxiliary switch 1 NO+1 NC

product brand name	SIRIUS
product designation	Circuit breaker
design of the product	For motor protection
product type designation	3RV2
General technical data	
Product equipment of circuit breaker for motor protection complete unit with protection device	Yes
size of the circuit-breaker	S0
size of contactor can be combined company-specific	S00, S0
product function disconnecter functionality	Yes
product extension auxiliary switch	Yes
power loss [W] for rated value of the current	
• at AC in hot operating state	7.25 W
• at AC in hot operating state per pole	2.4 W
type of calculation of power loss current-dependent	quadratic
insulation voltage with degree of pollution 3 at AC rated value	690 V
surge voltage resistance rated value	6 kV
maximum permissible voltage for protective separation	
• in networks with ungrounded star point between main and auxiliary circuit	400 V
• in networks with grounded star point between main and auxiliary circuit	400 V
protection class IP	
• on the front according to IEC 60529	IP20
• on the front	IP20
• of the terminal	IP20
shock resistance according to IEC 60068-2-27	25g / 11 ms
mechanical service life (operating cycles)	
• of the main contacts typical	100 000
• of auxiliary contacts typical	100 000
electrical endurance (operating cycles) typical	100 000
reference code according to IEC 81346-2	Q
continuous current rated value	0.63 A
Substance Prohibitance (day/month/year)	10/01/2009
SVHC substance name	Lead CAS-No. 7439-92-1
Net Weight	0.301 g
Ambient conditions	

installation altitude at height above sea level maximum	2 000 m
ambient temperature	
• during operation	-20 ... +60 °C
• during storage	-50 ... +80 °C
• during transport	-50 ... +80 °C
temperature compensation	-20 ... +60 °C
relative humidity during operation	10 ... 95 %
Main circuit	
number of poles for main current circuit	3
adjustable current response value current of the current-dependent overload release	0.45 ... 0.63 A
type of voltage for main current circuit	AC
operating voltage	
• rated value	690 V
• rated value	20 ... 690 V
• at AC-3 rated value maximum	690 V
• at AC-3e rated value maximum	690 V
operating frequency rated value	50 ... 60 Hz
operational current rated value	0.63 A
operational current	
• at AC-3 at 400 V rated value	0.63 A
• at AC-3e at 400 V rated value	0.63 A
operating power	
• at AC-3	
— at 230 V rated value	0.1 kW
— at 400 V rated value	0.2 kW
— at 500 V rated value	0.2 kW
— at 690 V rated value	0.3 kW
• at AC-3e	
— at 230 V rated value	0.1 kW
— at 400 V rated value	0.2 kW
— at 500 V rated value	0.2 kW
— at 690 V rated value	0.3 kW
operating frequency	
• at AC-3 maximum	15 1/h
• at AC-3e maximum	15 1/h
Auxiliary circuit	
design of the auxiliary switch	transverse
type of voltage for auxiliary and control circuit	AC/DC
number of NC contacts for auxiliary contacts	1
number of NO contacts for auxiliary contacts	1
number of CO contacts for auxiliary contacts	0
operational current of auxiliary contacts at AC-15	
• at 24 V	2 A
• at 120 V	0.5 A
• at 125 V	0.5 A
• at 230 V	0.5 A
operational current of auxiliary contacts at DC-13	
• at 24 V	1 A
• at 60 V	0.15 A
Protective and monitoring functions	
product function	
• ground fault detection	No
• phase failure detection	Yes
trip class	CLASS 10
design of the overload release	thermal
protection function thermal overload protection (ANSI 49)	Yes
maximum short-circuit current breaking capacity (Icu)	
• at AC at 240 V rated value	100 kA

<ul style="list-style-type: none"> • at AC at 400 V rated value • at AC at 500 V rated value • at AC at 690 V rated value 	100 kA 100 kA 100 kA
operating short-circuit current breaking capacity (Ics) at AC	
<ul style="list-style-type: none"> • at 240 V rated value • at 400 V rated value • at 500 V rated value • at 690 V rated value 	100 kA 100 kA 100 kA 100 kA
response value current of instantaneous short-circuit trip unit	8.2 A
UL/CSA ratings	
full-load current (FLA) for 3-phase AC motor	
<ul style="list-style-type: none"> • at 480 V rated value • at 600 V rated value 	0.63 A 0.63 A
contact rating of auxiliary contacts according to UL	C300 / R300
UL File Number (CCN)	E47705 (NLRV, NLRV7), E156943 (NKJH, NKJH7)
Short-circuit protection	
product function short circuit protection	Yes
design of the short-circuit trip	magnetic
design of the fuse link	
<ul style="list-style-type: none"> • for short-circuit protection of the auxiliary switch required 	Fuse gL/gG: 10 A, miniature circuit breaker C 6 A (short-circuit current I _k < 400 A)
certificate of suitability according to ATEX directive 2014/34/EU	DMT 02 ATEX F 001
type of protection according to ATEX directive 2014/34/EU	Ex II (2) GD
Installation/ mounting/ dimensions	
mounting position	any
fastening method	screw and snap-on mounting onto 35 mm DIN rail according to DIN EN 60715
Mounting method of circuit breaker for Transformer protection, Generator protection and system protection optional standard bar mounting	Yes
height	97 mm
width	45 mm
depth	97 mm
required spacing	
<ul style="list-style-type: none"> • with side-by-side mounting <ul style="list-style-type: none"> — forwards — backwards — upwards — downwards — at the side • for grounded parts <ul style="list-style-type: none"> — forwards — backwards — upwards — at the side — downwards • for live parts <ul style="list-style-type: none"> — forwards — backwards — upwards — downwards — at the side • for grounded parts at 400 V <ul style="list-style-type: none"> — downwards — upwards — at the side • for live parts at 400 V <ul style="list-style-type: none"> — downwards — upwards — at the side • for grounded parts at 500 V 	0 mm 0 mm 50 mm 50 mm 0 mm 0 mm 0 mm 50 mm 30 mm 50 mm 0 mm 0 mm 50 mm 50 mm 30 mm 30 mm 30 mm 9 mm 30 mm 30 mm 9 mm

— downwards	30 mm
— upwards	30 mm
— at the side	9 mm
● for live parts at 500 V	
— downwards	30 mm
— upwards	30 mm
— at the side	9 mm
● for grounded parts at 690 V	
— downwards	50 mm
— upwards	50 mm
— backwards	0 mm
— at the side	30 mm
— forwards	0 mm
● for live parts at 690 V	
— downwards	50 mm
— upwards	50 mm
— backwards	0 mm
— at the side	30 mm
— forwards	0 mm
Connections/ Terminals	
product component removable terminal for auxiliary and control circuit	No
type of electrical connection	
● for main current circuit	screw-type terminals
● for auxiliary and control circuit	screw-type terminals
arrangement of electrical connectors for main current circuit	Top and bottom
type of connectable conductor cross-sections	
● for main contacts	
— solid or stranded	2x (1 ... 2.5 mm ²), 2x (2.5 ... 10 mm ²)
— finely stranded with core end processing	2x (1 ... 2.5 mm ²), 2x (2.5 ... 6 mm ²), 1x 10 mm ²
● for AWG cables for main contacts	2x (16 ... 12), 2x (14 ... 8)
connectable conductor cross-section for main contacts	
● solid or stranded	1 ... 10 mm ²
● finely stranded with core end processing	1 ... 10 mm ²
connectable conductor cross-section for auxiliary contacts	
● solid or stranded	0.5 ... 2.5 mm ²
● finely stranded with core end processing	0.5 ... 2.5 mm ²
type of connectable conductor cross-sections	
● for auxiliary contacts	
— solid or stranded	2x (0.5 ... 1.5 mm ²), 2x (0.75 ... 2.5 mm ²)
— finely stranded with core end processing	2x (0.5 ... 1.5 mm ²), 2x (0.75 ... 2.5 mm ²)
● for AWG cables for auxiliary contacts	2x (20 ... 16), 2x (18 ... 14)
AWG number as coded connectable conductor cross section for main contacts	16 ... 8
AWG number as coded connectable conductor cross section for auxiliary contacts	20 ... 14
tightening torque	
● for main contacts with screw-type terminals	2 ... 2.5 N·m
● for auxiliary contacts with screw-type terminals	0.8 ... 1.2 N·m
design of screwdriver shaft	Diameter 5 to 6 mm
size of the screwdriver tip	Pozidriv size 2
design of the thread of the connection screw	
● for main contacts	M4
● of the auxiliary and control contacts	M3
Safety related data	
product function suitable for safety function	Yes
suitability for use	
● safety-related switching on	No
● safety-related switching OFF	Yes

service life maximum	10 a	
test wear-related service life necessary	Yes	
proportion of dangerous failures		
• with low demand rate according to SN 31920	40 %	
• with high demand rate according to SN 31920	50 %	
B10 value with high demand rate according to SN 31920	5 000	
failure rate [FIT] with low demand rate according to SN 31920	50 FIT	
ISO 13849		
device type according to ISO 13849-1	3	
overdimensioning according to ISO 13849-2 necessary	Yes	
IEC 61508		
safety device type according to IEC 61508-2	Type A	
T1 value		
• for proof test interval or service life according to IEC 61508	10 a	
Electrical Safety		
protection class IP on the front according to IEC 60529	IP20	
touch protection on the front according to IEC 60529	finger-safe, for vertical contact from the front	
Display		
display version for switching status	Handle	
Approvals Certificates		
Environmental Product Declaration		
<ul style="list-style-type: none"> • global warming potential [CO2 eq] / during manufacturing • global warming potential [CO2 eq] / during sales • global warming potential [CO2 eq] / during operation • global warming potential [CO2 eq] / after end of life • global warming potential [CO2 eq] / total 	<ul style="list-style-type: none"> 2.68 kg 0.143 kg 72.7 kg -0.445 kg 75.078 kg 	
Environment	General Product Approval	
Environmental Certifications     		
General Product Approval		
     		
For use in hazardous locations	Test Certificates	Maritime application
 	Special Test Certificate Type Test Certificates/Test Report	 
Maritime application	other	
   	Miscellaneous	Confirmation
other	Railway	



Further information

Information on the packaging

<https://support.industry.siemens.com/cs/ww/en/view/109813875>

Information for data generation and storage

<https://support.industry.siemens.com/cs/ww/en/view/109995012>

Information- and Downloadcenter (Catalogs, Brochures,...)

<https://www.siemens.com/ic10>

Industry Mall (Online ordering system)

<https://mall.industry.siemens.com/mall/en/en/Catalog/product?mlfb=3RV2021-0GA15>

Service&Support (Manuals, Certificates, Characteristics, FAQs,...)

<https://support.industry.siemens.com/cs/ww/en/ps/3RV2021-0GA15>

Image database (product images, 2D dimension drawings, 3D models, device circuit diagrams, EPLAN macros, ...)

https://www.automation.siemens.com/bilddb/cax_de.aspx?mlfb=3RV2021-0GA15&lang=en

Cax online generator

<https://support.automation.siemens.com/WW/CAXorder/default.aspx?lang=en&mlfb=3RV2021-0GA15>

Characteristic curves

[https://curves.simaris.siemens.com/curves/<mmp_prod_noCOMP="HAUPT"></mmp_prod_no>](https://curves.simaris.siemens.com/curves/<mmp_prod_noCOMP=)

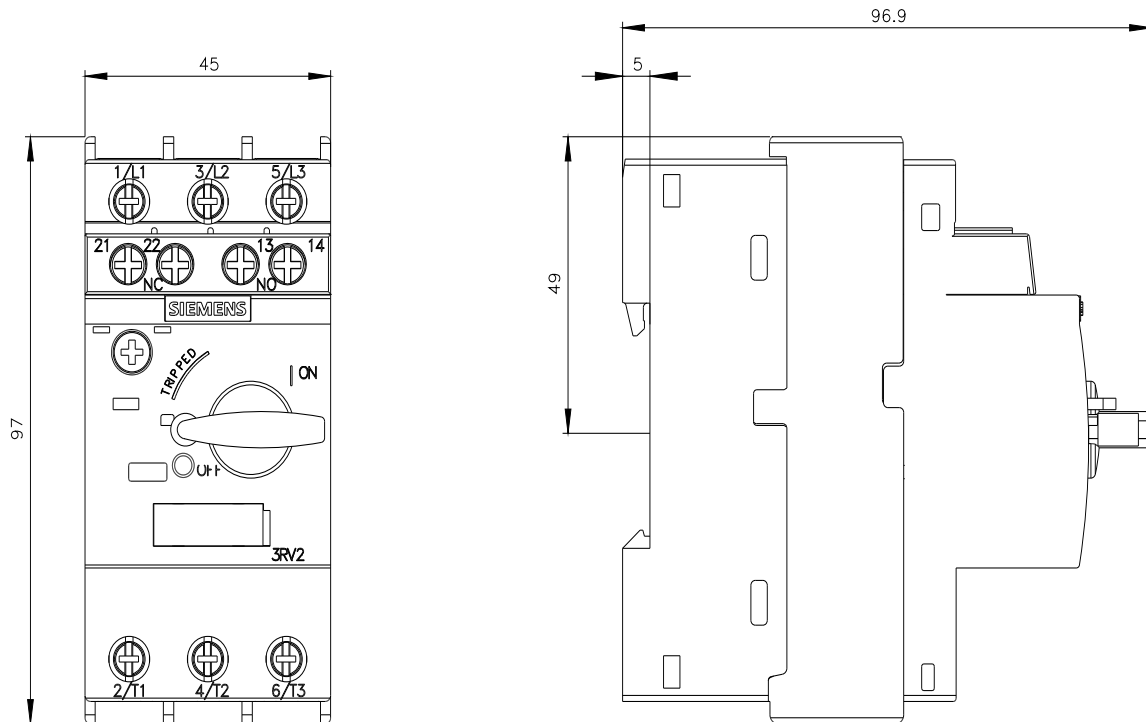

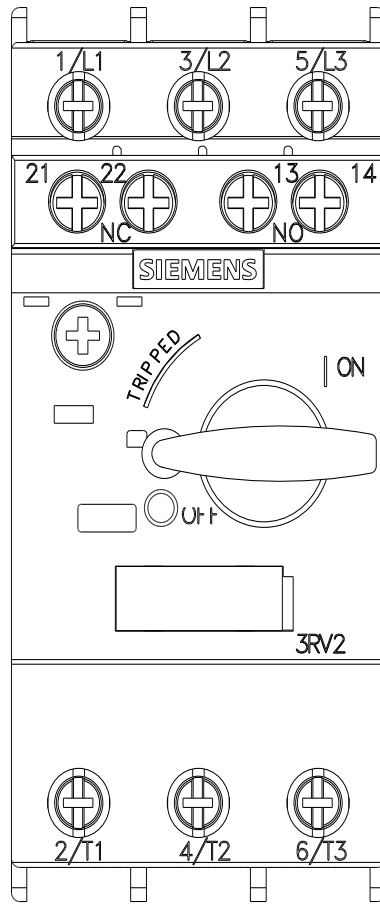

last modified:

5/5/2026