



Main

Range	TeSys
Product name	TeSys D
Product or component type	Star delta starter
Device short name	LC3D
Contactor application	Motor control
Utilisation category	AC-3
Device presentation	Pre-wired
Poles description	3 x 3P
Power pole contact composition	3 x 3 NO
[Ue] rated operational voltage	Power circuit <= 690 V AC 25...400 Hz
[Ie] rated operational current	32 A 140 °F (60 °C) <= 440 V AC AC-3 power circuit
Motor power kW	15 KW 220/230 V AC 50/60 Hz 25 KW at 380/400 V AC 50/60 Hz 30 KW at 415 V AC 50/60 Hz 30 kW 440 V AC 50/60 Hz
Control circuit type	AC 50/60 Hz
[Uc] control circuit voltage	230 V AC 50/60 Hz
Auxiliary contact composition	1 NC KM1 star contactor
[Uimp] rated impulse withstand voltage	6 kV IEC 60947
Overvoltage category	III
[Ui] rated insulation voltage	Power circuit 690 V IEC 60947-4-1 Power circuit 600 V CSA Power circuit 600 V UL Signalling circuit 690 V IEC 60947-1 Signalling circuit 600 V CSA Signalling circuit 600 V UL
Electrical durability	1.65 Mcycles 32 A AC-3 <= 440 V
Safety cover	Protective cover
Interlocking type	Mechanical
Mounting support	Plate
Standards	EN 60947-4-1 IEC 60947-5-1 CSA C22.2 No 14 EN 60947-5-1 UL 508 IEC 60947-4-1
Product certifications	GOST RINA UL CSA BV DNV LROS (Lloyds register of shipping) CCC GL

The information provided in this documentation contains general descriptions and/or technical characteristics of the performance of the products contained herein. This documentation is not intended as a substitute for and is not to be used for determining suitability or reliability of these products for specific user applications. It is the duty of any such user or integrator to perform the appropriate and complete risk analysis, evaluation and testing of the products with respect to the relevant specific application or use thereof. Neither Schneider Electric Industries SAS nor any of its affiliates or subsidiaries shall be responsible or liable for misuse of the information contained herein.

Complementary

Connections - terminals	Control circuit screw clamp terminals 1 0.00...0.01 in ² (1...4 mm ²) flexible without cable end Control circuit screw clamp terminals 2 0.00...0.01 in ² (1...4 mm ²) flexible without cable end Control circuit screw clamp terminals 1 0.00...0.01 in ² (1...4 mm ²) flexible with cable end Control circuit screw clamp terminals 2 0.00...0.00 in ² (1...2.5 mm ²) flexible with cable end Control circuit screw clamp terminals 1 0.00...0.01 in ² (1...4 mm ²) solid without cable end Control circuit screw clamp terminals 2 0.00...0.01 in ² (1...4 mm ²) solid without cable end Power circuit screw clamp terminals 1 0.00...0.02 in ² (2.5...10 mm ²) flexible without cable end Power circuit screw clamp terminals 2 0.00...0.02 in ² (2.5...10 mm ²) flexible without cable end Power circuit screw clamp terminals 1 0.00...0.02 in ² (1...10 mm ²) flexible with cable end Power circuit screw clamp terminals 2 0.00...0.01 in ² (1.5...6 mm ²) flexible with cable end Power circuit screw clamp terminals 1 0.00...0.02 in ² (1.5...10 mm ²) solid without cable end Power circuit screw clamp terminals 2 0.00...0.02 in ² (2.5...10 mm ²) solid without cable end
Tightening torque	Control circuit 15.05 lbf.in (1.7 N.m) screw clamp terminals flat Ø 6 mm Control circuit 15.05 lbf.in (1.7 N.m) screw clamp terminals Philips No 2 Power circuit 22.13 lbf.in (2.5 N.m) screw clamp terminals flat Ø 6 mm Power circuit 22.13 lbf.in (2.5 N.m) screw clamp terminals Philips No 2
Mechanical durability	15 Mcycles
Maximum operating rate	30 cyc/h 140 °F (60 °C)
Starting time	30 s
Coil technology	Without built-in suppressor module
Control circuit voltage limits	Drop-out 0.3...0.6 Uc 50/60 Hz 140 °F (60 °C) Operational 0.8...1.1 Uc 50 Hz 140 °F (60 °C) Operational 0.85...1.1 Uc 60 Hz 140 °F (60 °C)
Inrush power in VA	70 VA 60 Hz 0.75 68 °F (20 °C) 70 VA 50 Hz 0.75 68 °F (20 °C)
Hold-in power consumption in VA	7.5 VA 60 Hz 0.3 68 °F (20 °C) 7 VA 50 Hz 0.3 68 °F (20 °C)
Heat dissipation	2...3 W 50/60 Hz
Auxiliary contacts type	Mechanically linked IEC 60947-5-1 3 x 1 NO + 1 NC Mirror contact IEC 60947-4-1 3 x 1 NC
Signalling circuit frequency	25...400 Hz
Minimum switching current	5 mA signalling circuit
Minimum switching voltage	17 V signalling circuit
Non-overlap time	1.5 Ms on de-energisation between NC and NO contact 1.5 ms on energisation between NC and NO contact
Maximum Width	6.54 in (166 mm)
Height	4.88 in (124 mm)
Depth	5.87 in (149 mm)
Net Weight	4.48 lb(US) (2.03 kg)

Environment

Insulation resistance	> 10 MOhm signalling circuit
IP degree of protection	IP20 front face IEC 60529
Protective treatment	TH IEC 60068-2-30
Pollution degree	3
Ambient air temperature for storage	-76...176 °F (-60...80 °C)
Ambient air temperature for operation	-40...158 °F (-40...70 °C) at Uc
Operating altitude	9842.52 ft (3000 m) without derating
Fire resistance	1562 °F (850 °C) IEC 60695-2-1

Flame retardance	V1 UL 94
Mechanical robustness	Vibrations contactor open2 Gn, 5...300 Hz Vibrations contactor closed4 Gn, 5...300 Hz Shocks contactor closed15 Gn for 11 ms Shocks contactor open8 Gn for 11 ms







Ordering and shipping details

Category	22316 - **OBS**CTR,D-LINE,AC,NR
Discount Schedule	I12
GTIN	03389110550382
Nbr. of units in pkg.	1
Package weight(Lbs)	3.89 lb(US) (1.76 kg)
Returnability	No
Country of origin	FR

Packing Units

Unit Type of Package 1	PCE
Package 1 Height	6.85 in (17.4 cm)
Package 1 width	6.26 in (15.9 cm)
Package 1 Length	9.06 in (23 cm)

Offer Sustainability

Sustainable offer status	Green Premium product
California proposition 65	WARNING: This product can expose you to chemicals including: Antimony oxide & Antimony trioxide, which is known to the State of California to cause cancer. For more information go to www.P65Warnings.ca.gov
REACH Regulation	 REACH Declaration
REACH free of SVHC	Yes
EU RoHS Directive	Compliant  EU RoHS Declaration
Toxic heavy metal free	Yes
Mercury free	Yes
RoHS exemption information	 Yes
China RoHS Regulation	 China RoHS Declaration
Environmental Disclosure	 Product Environmental Profile
Circularity Profile	 End Of Life Information
WEEE	The product must be disposed on European Union markets following specific waste collection and never end up in rubbish bins.
PVC free	Yes

Contractual warranty

Warranty	18 months
----------	-----------

Dimensions

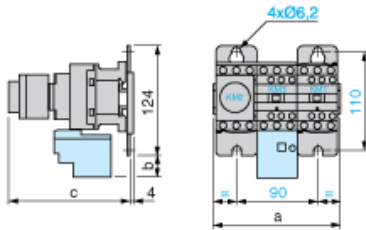

LC3		D09A	D12A	D18A	D32A
a		143	143	144	165
b		26.5	26.5	26.5	32.5
c	with LAD S	139	139	139	145
with LAD S and sealing cover	143	143	143	149	

Wiring

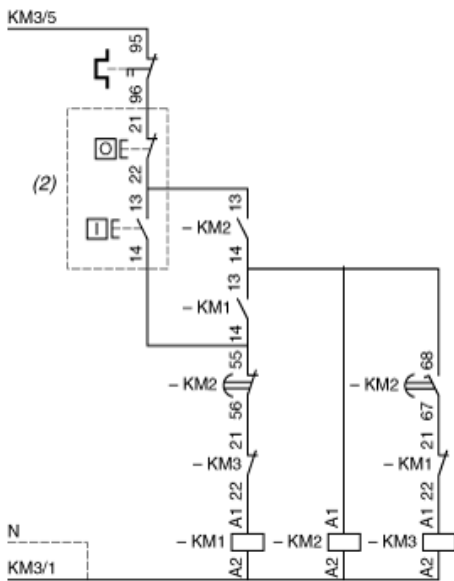
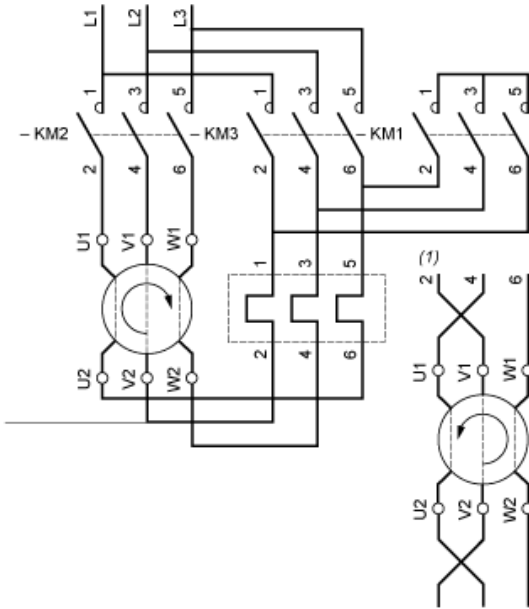

- (1) Recommended cabling for reversal of motor rotation (standard motor, viewed from shaft end).
- (2) Remote control.

NOTE: LC3 D09A to D18A: Mechanical interlock between KM3 and KM1.