



TAOGLAS®



Datasheet

Taoglas Reach Series - PCS.68.A

Description:

Reach Low Profile Wideband 5G/4G PCB SMD Antenna

Features:

- Patent Pending Innovative Low Profile Design
- High Efficiency Wideband Antenna, Covering 600 to 6000 MHz
- Supporting 5G FR1 Bands
- 600 MHz 5G/4G Band 71 Support
- Surface Mount Distribution (SMD) - Supplied on Tape & Reel
- Manufactured in an IATF16949 Certified Facility
- Dimensions: 42 x 10 x 1.5 mm
- RoHS & REACH Compliant

1. Introduction	3
2. Specifications	5
3. Antenna Characteristics	7
4. Radiation Patterns	11
5. Mechanical Drawing	16
6. Matching Circuit	18
7. Packaging	19
<hr/>	
Changelog	20

Taoglas makes no warranties based on the accuracy or completeness of the contents of this document and reserves the right to make changes to specifications and product descriptions at any time without notice. Taoglas reserves all rights to this document and the information contained herein. Reproduction, use or disclosure to third parties without express permission is strictly prohibited.



1. Introduction



The Taoglas Reach Series PCS.68.A is a revolutionary 5G/4G, low profile, small footprint, patent pending, SMD mount PCB wide-band antenna. The PCS.68.A has been designed to cover all 5G and 4G bands, including all sub-6GHz deployments across the 600MHz to 6000MHz spectrum in a very small footprint of just 42 x 10mm. It also covers 3G/ 2G bands to allow for fall-back when 5G/4G is not available. The low profile size of just 1.5mm in height allows for installation where height is at a premium.

Typical applications include

- Autonomous/UAVs
- Smart Metering
- Connected Health
- Wearable Technologies
- Payment Terminals

The patent pending design uses printed circuit board material and innovative design techniques to deliver the highest efficiencies at all bands when mounted on the device's main PCB. The PCS.68.A is suitable for lower cost 5G/4G applications, especially IoT projects requiring wide bandwidth and comes supplied on tape and reel to allow it to be mounted via 'pick & place' onto the PCB.

If tuning is required, it can also be tuned specifically depending on device environment. Contact your local Taoglas customer support team for advice on integrating the PCS.68.A into your device.

1.1 Key Advantages

1. Highest efficiency in small footprint

A comparative antenna to the Reach, for example, metal/ceramic/FPC, would have much-reduced efficiency in this configuration due to their high substrate loss at high frequencies. Very high efficiency antennas are critical to 5G/4G devices ability to deliver the stated data-speed rates of systems such as 5G /4G.

2. Low profile

Many applications require a large mechanical size to work efficiently, which occupies the usable PCB space. The size of PCS.68 is only 42mm X 10mm (420mm²), and if accounting for the 4mm keep out area, the total area consumed on the PCB is only 42mmX14mm = 588mm². The solution allows board designers to maximize their PCB space.

3. Adaptable

The high radiation efficiency of the Reach over its entire operating bandwidth means that the total efficiency is only limited by the impedance mismatch loss. As a result, this antenna has been optimized via a matching network to 600MHz – 960MHz and 1710MHz – 6000MHz with the minimum efficiencies of 30% and 50% respectively. The performance of direct feeding the antenna without a matching circuit is good from 730MHz – 960MHz and 1710MHz – 6000MHz.

4. More resistant to detuning compared to other antenna integrations

If tuning is required it can be tuned for the device environment using a matching circuit, or other techniques on the main PCB itself. There is no need for new tooling, thereby saving money if customization is required.

5. Surface Mount Device (SMD)

Direct mount, 'on-board' antennas save on labor, cable and connector costs, lead to higher integration yield rates and reduce losses in transmission.

6. Minimum Transmission and Reception Losses

These are kept to an absolute minimum resulting in much improved OTA (over the air), i.e. TRP (Total Radiated Power) / TIS (Total Isotropic Radiation), device performance compared to similar efficiency cable and connector antenna solutions. This means it is an ideal antenna to be used for devices that This means it is an ideal antenna to be used for devices that need to pass for example USA carrier network approvals.

2. Specifications

Electrical								
Band	Frequency (MHz)	Efficiency (%)	Average Gain (dB)	Peak Gain (dBi)	VSWR	Impedance	Polarization	Radiation Pattern
5G NR/4G Band 5,8,12,13,14,17,18,20, 26,27,28, 29,71	617~960	45	-3.3	-1	<3.5:1	50 Ω	Linear	Omni
5G NR/4G Band 21,32,74,75,76	1427~1518	25	-7	-2				
4G/3G Band 1,2,3,4,9,23,25,35,39,66	1710~2200	77	-1.2	3.8				
Wi-Fi 2400	2400~2500	53	-2.7	2				
4G/3G Band 7,38,41	2490~2690	62	-2.2	4				
5G NR/4G Band 22,42,43,48,77,78,79	3300~5000	67	-2	4.5				
LTE5200/ Wi-Fi 5800	5150~5925	77	-1	4				

The PCS.86.A antenna performance was measured on a 130 x 42 ground plane

Mechanical	
Dimensions	42mm x 10mm x 1.5mm
Weight	2g
Material	PCB
Termination	Solder Pad
EVB Connector	SMA-Female

Environmental	
Operation Temperature	-40°C to 85°C
Storage Temperature	-40°C to 105°C
Relative Humidity	Non-condensing 65°C 95% RH
RoHs & REACH Compliant	Yes

5G/4G Bands			
Band Number	5G NR / FR1 / LTE / LTE-Advanced / WCDMA / HSPA / HSPA+ / TD-SCDMA		
	Uplink	Downlink	Covered
1	UL: 1920 to 1980	DL: 2110 to 2170	✓
2	UL: 1850 to 1910	DL: 1930 to 1990	✓
3	UL: 1710 to 1785	DL: 1805 to 1880	✓
4	UL: 1710 to 1755	DL: 2110 to 2155	✓
5	UL: 824 to 849	DL: 869 to 894	✓
7	UL: 2500 to 2570	DL: 2620 to 2690	✓
8	UL: 880 to 915	DL: 925 to 960	✓
9	UL: 1749.9 to 1784.9	DL: 1844.9 to 1879.9	✓
11	UL: 1427.9 to 1447.9	DL: 1475.9 to 1495.9	✓
12	UL: 699 to 716	DL: 729 to 746	✓
13	UL: 777 to 787	DL: 746 to 756	✓
14	UL: 788 to 798	DL: 758 to 768	✓
17	UL: 704 to 716	DL: 734 to 746	✓
18	UL: 815 to 830	DL: 860 to 875	✓
19	UL: 830 to 845	DL: 875 to 890	✓
20	UL: 832 to 862	DL: 791 to 821	✓
21	UL: 1447.9 to 1462.9	DL: 1495.9 to 1510.9	✓
22	UL: 3410 to 3490	DL: 3510 to 3590	✓
23	UL: 2000 to 2020	DL: 2180 to 2200	✓
24	UL: 1625.5 to 1660.5	DL: 1525 to 1559	✓
25	UL: 1850 to 1915	DL: 1930 to 1995	✓
26	UL: 814 to 849	DL: 859 to 894	✓
27	UL: 807 to 824	DL: 852 to 869	✓
28	UL: 703 to 748	DL: 758 to 803	✓
29	UL: -	DL: 717 to 728	✓
30	UL: 2305 to 2315	DL: 2350 to 2360	✓
31	UL: 452.5 to 457.5	DL: 462.5 to 467.5	✗
32	UL: -	DL: 1452 – 1496	✓
35		1850 to 1910	✓
38		2570 to 2620	✓
39		1880 to 1920	✓
40		2300 to 2400	✓
41		2496 to 2690	✓
42		3400 to 3600	✓
43		3600 to 3800	✓
48		3550 to 3700	✓
66	UL: 1710-1780	DL: 2110-2200	✓
71		617 to 698	✓
74/75/76		1427 to 1518	✓
77		3300 to 4200	✓
78		3300 to 3800	✓
79		4400 to 5000	✓

3. Antenna Characteristics

3.1 Test Setup

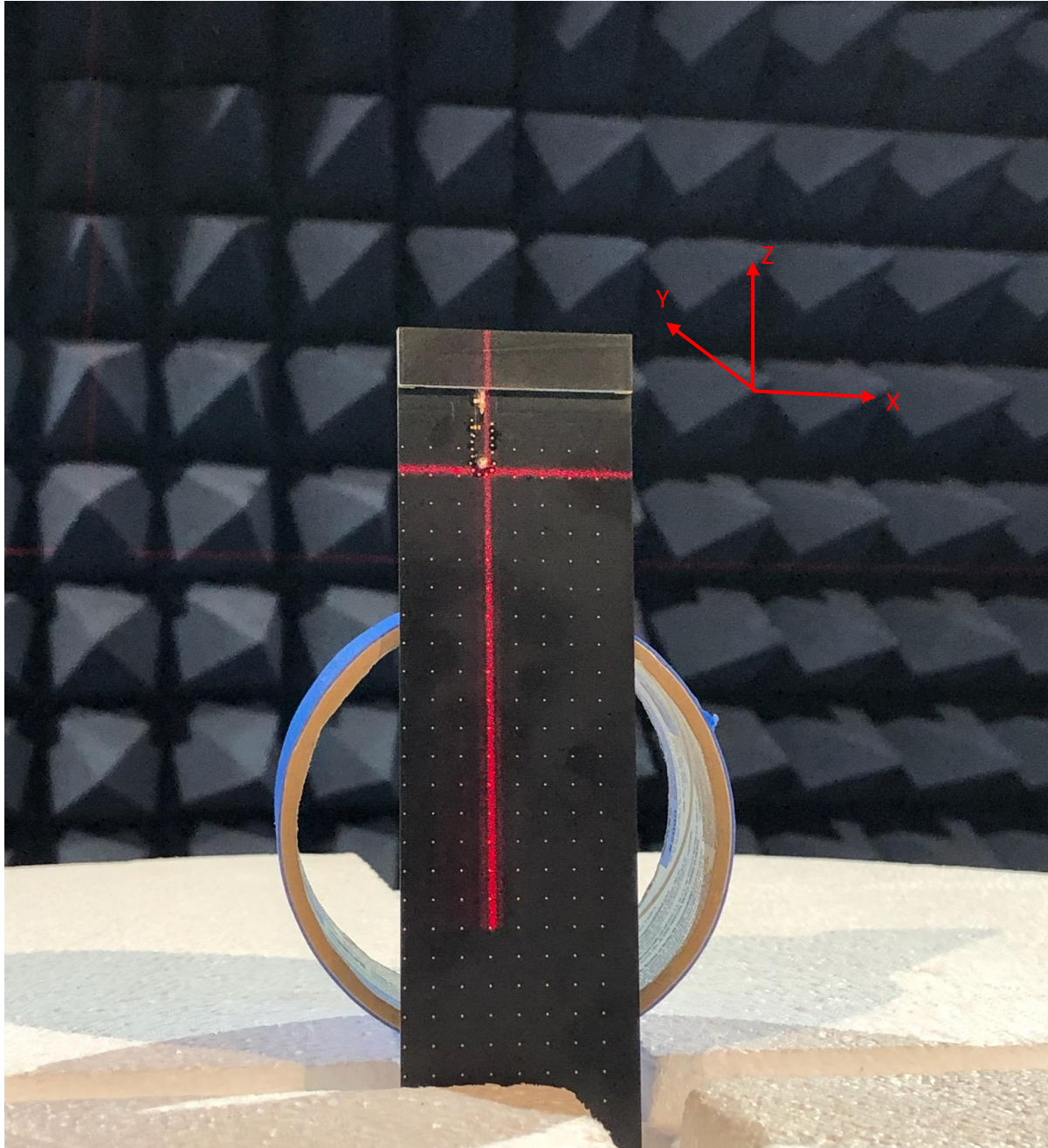

On Evaluation Board

3.2 Return Loss

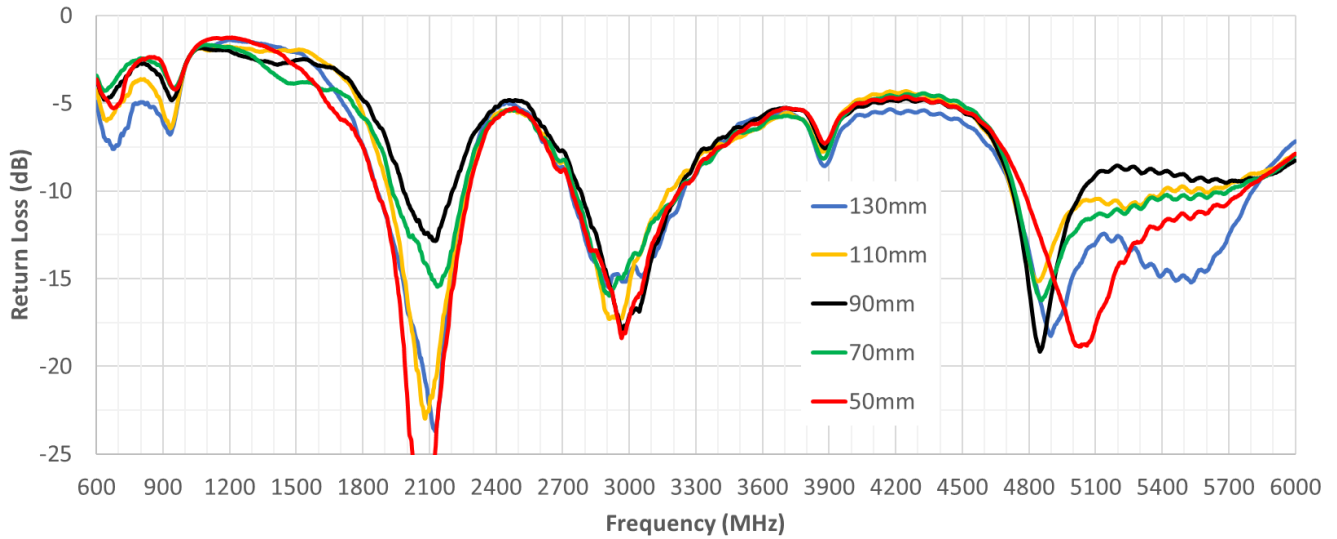

Analysis of the effect of reducing ground plane length

3.3 VSWR

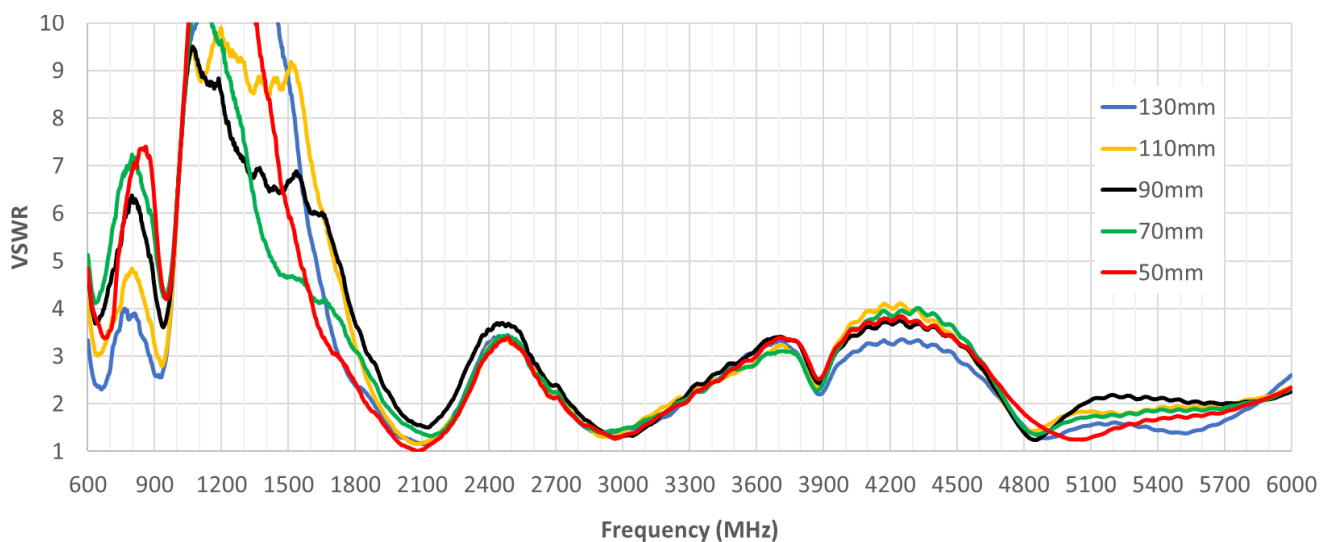

Analysis of the effect of reducing ground plane length

3.4 Efficiency

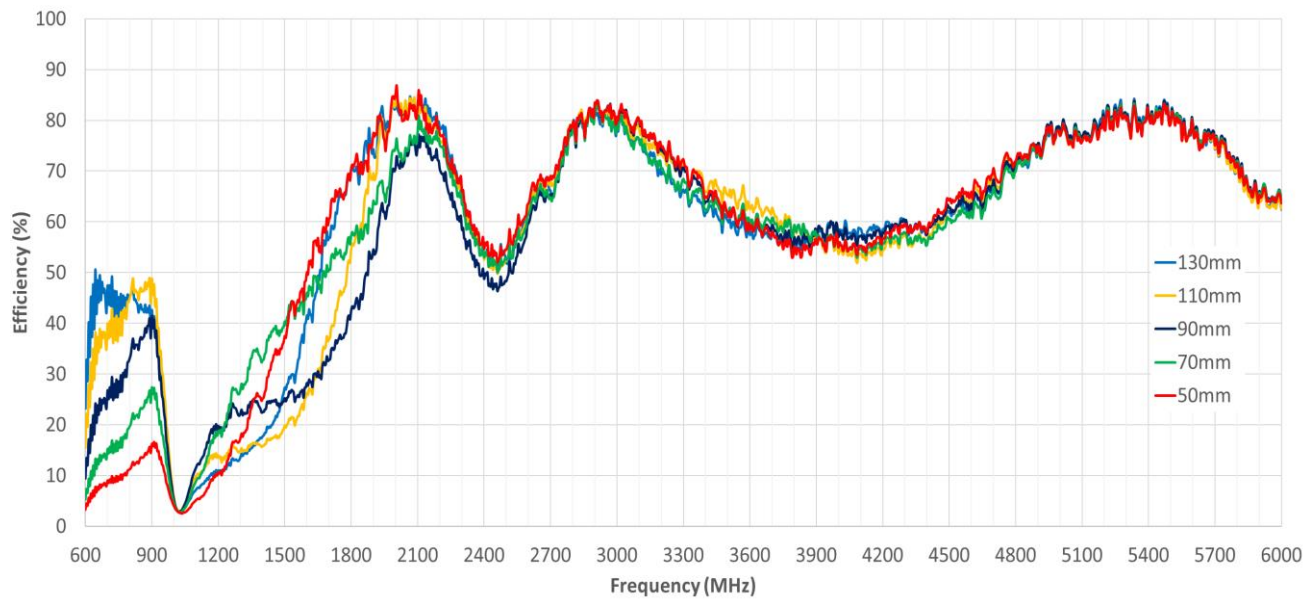

Analysis of the effect of reducing ground plane length

3.5 Peak Gain

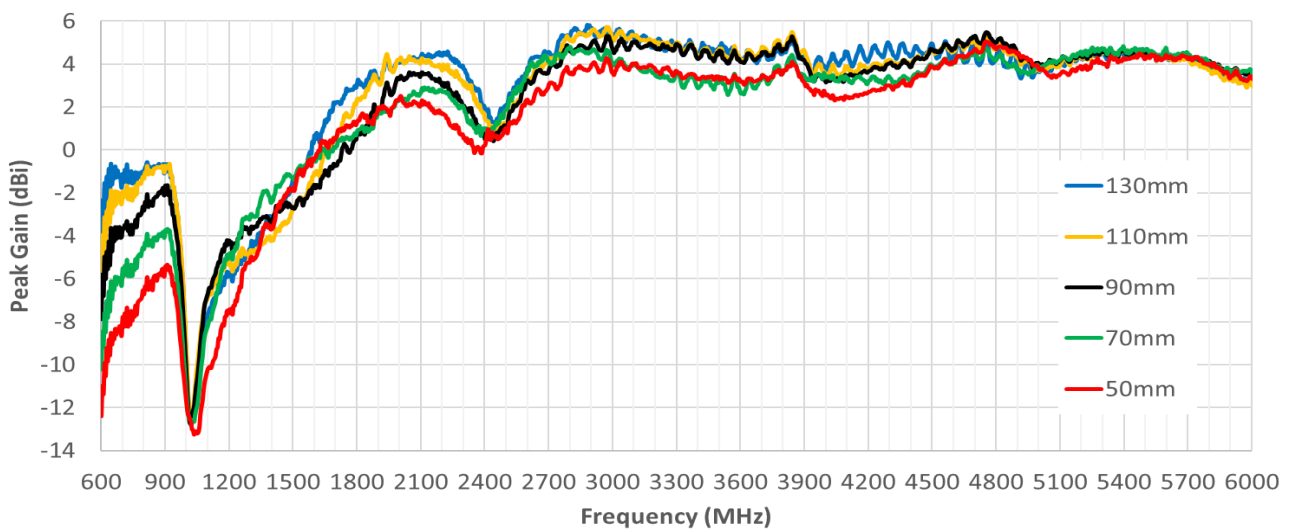

Analysis of the effect of reducing ground plane length

3.6 Average Gain

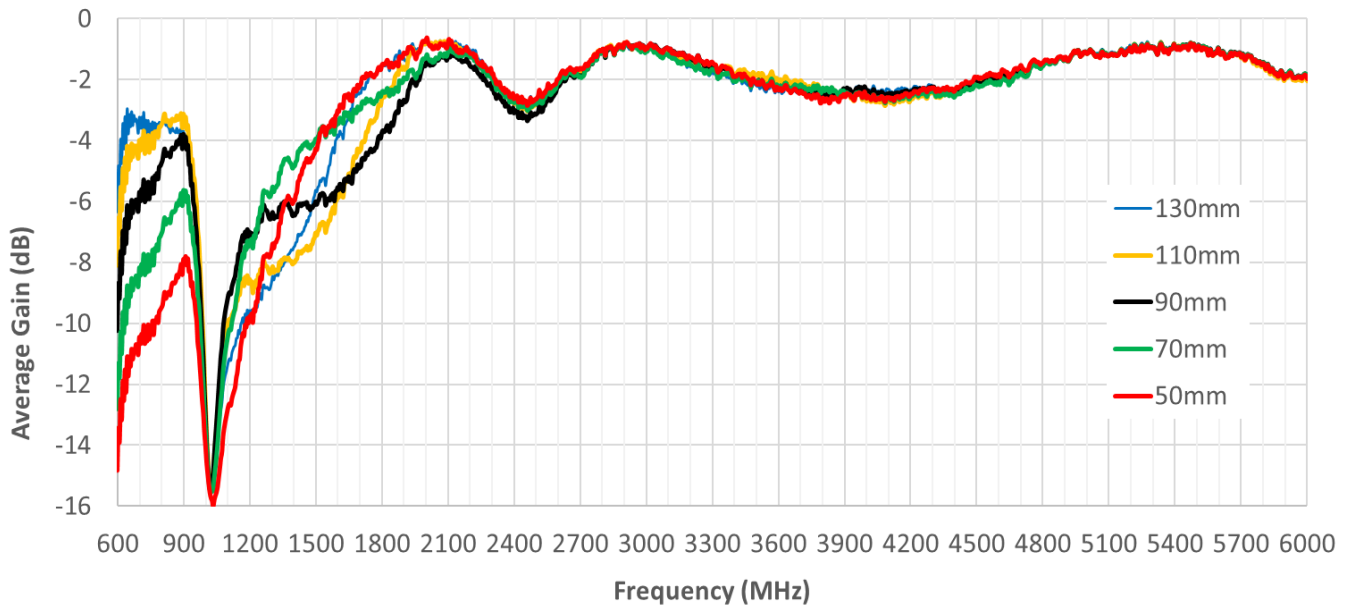

Analysis of the effect of reducing ground plane length

4. Radiation Patterns (Measured on 130 X 42mm EVB)

4.1 800MHz 3D and 2D Radiation Patterns

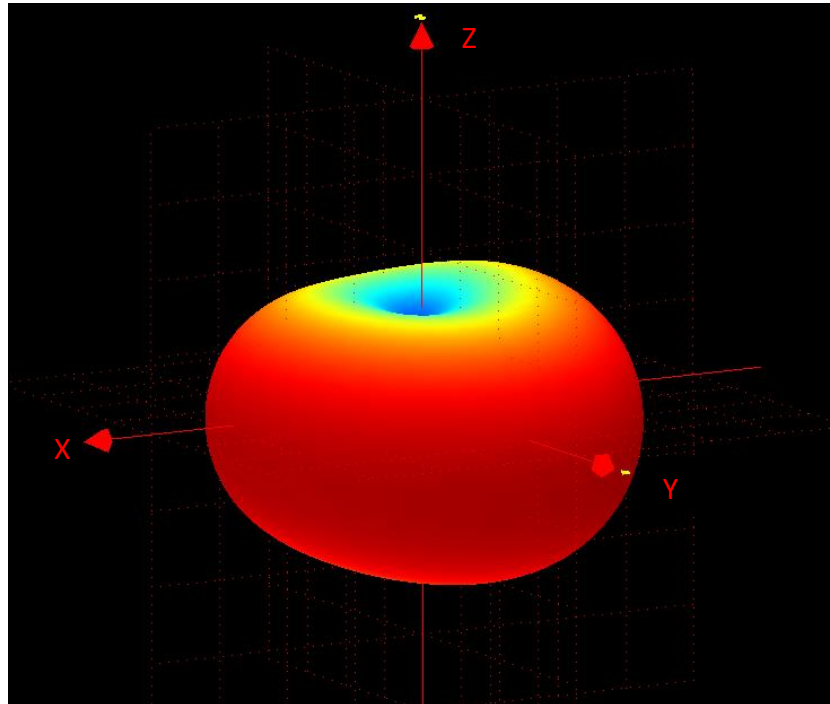

XY Plane

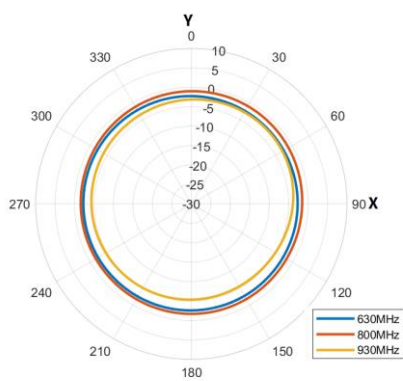

XZ Plane

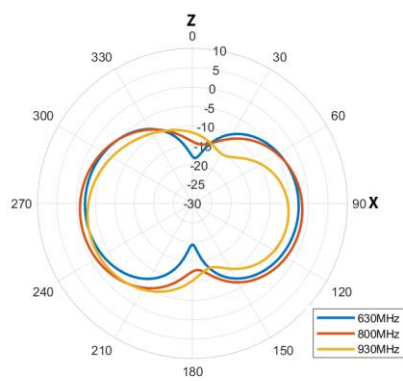

YZ Plane

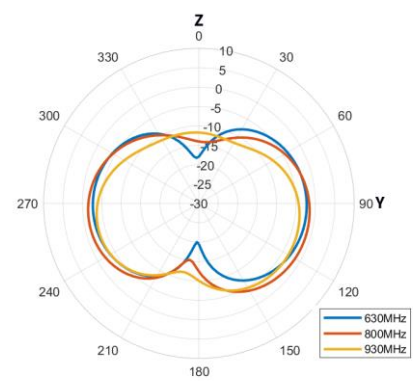

4.2 1470MHz 3D and 2D Radiation Patterns

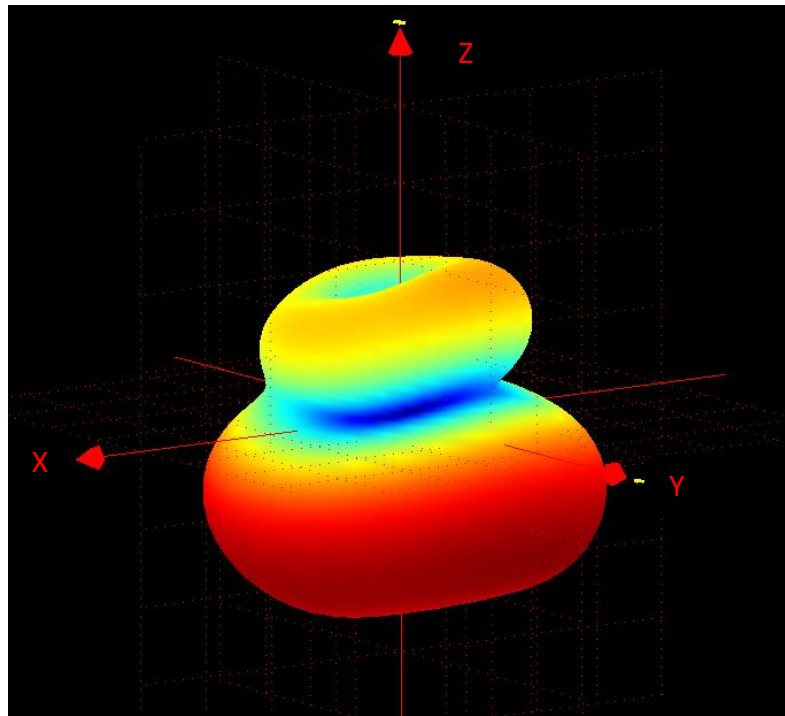

XY Plane XZ Plane YZ Plane

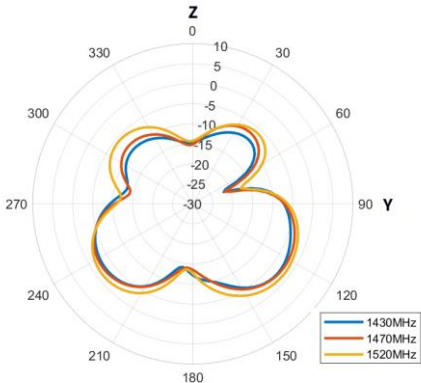
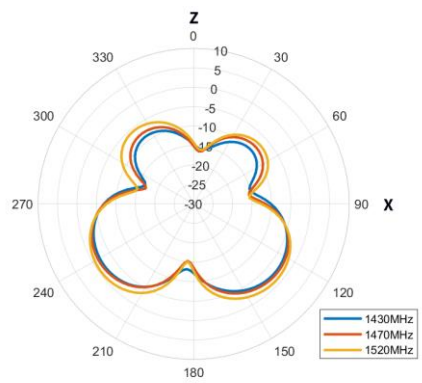
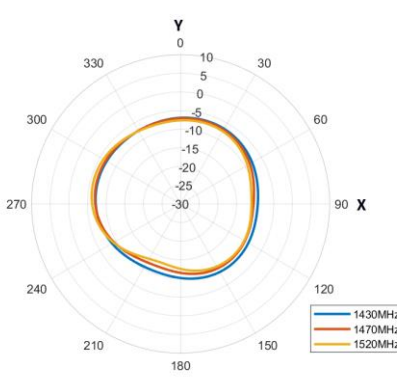

4.3 1910MHz 3D and 2D Radiation Patterns

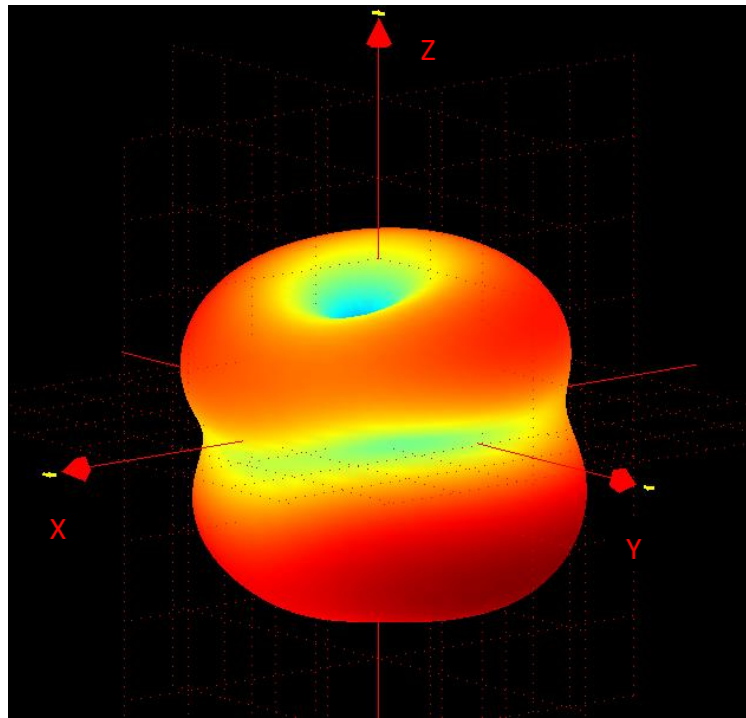

XY Plane

XZ Plane

YZ Plane

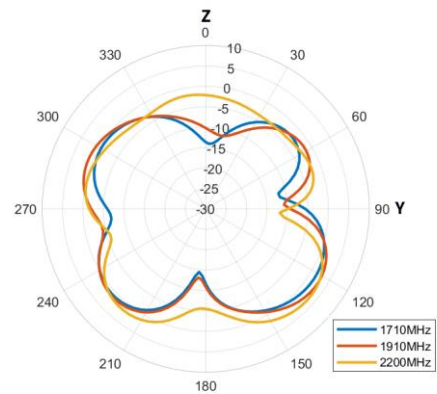
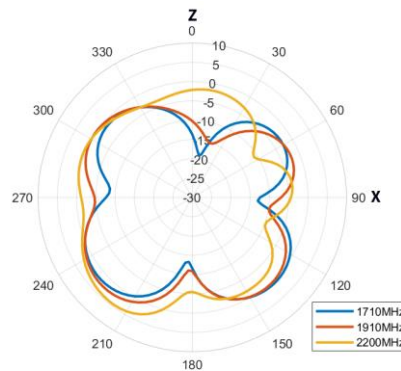
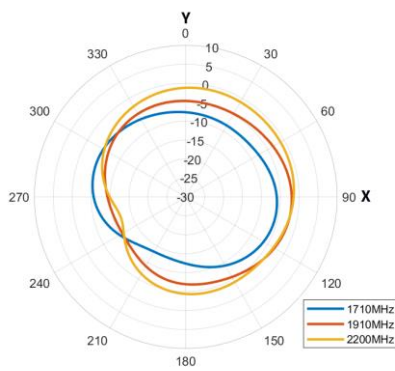

4.4 2550MHz 3D and 2D Radiation Patterns

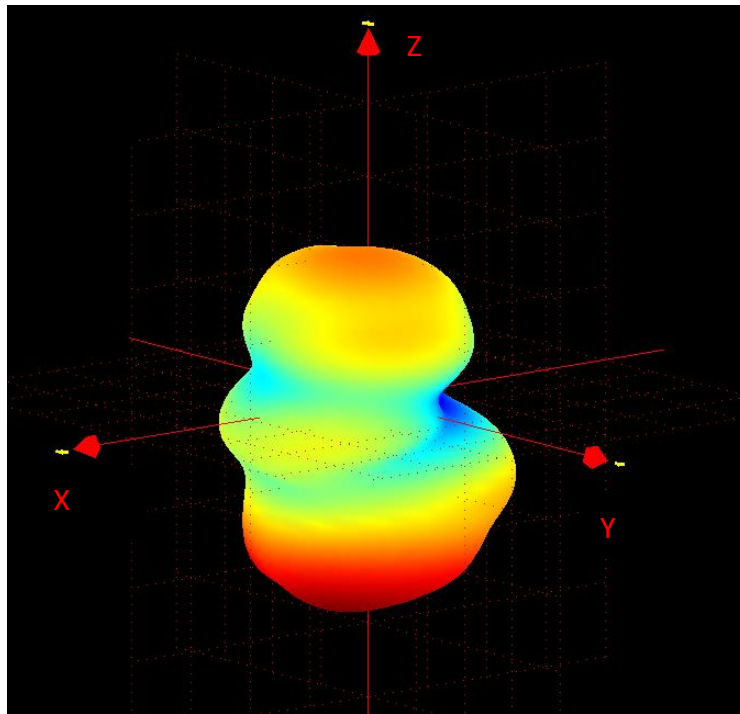

XY Plane XZ Plane YZ Plane

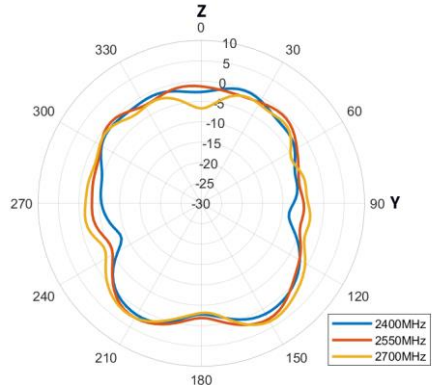
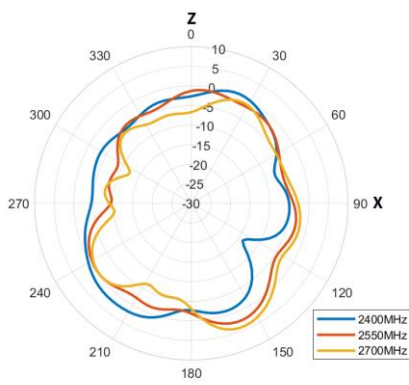
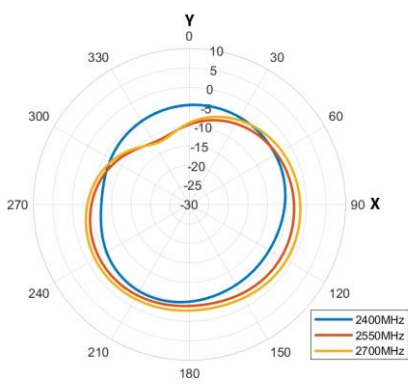

4.5 4500MHz 3D and 2D Radiation Patterns

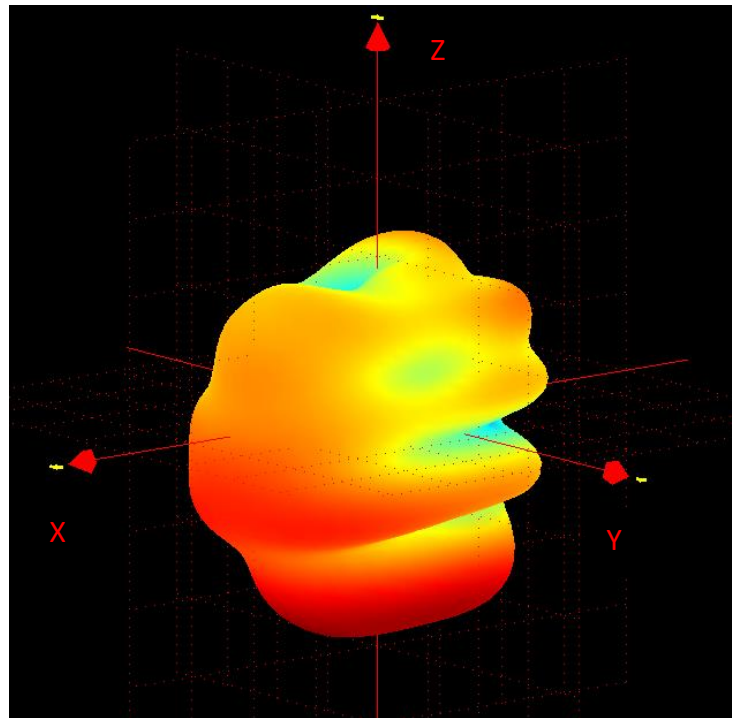

XY Plane XZ Plane YZ Plane

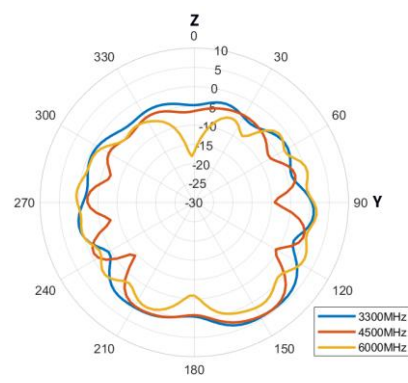
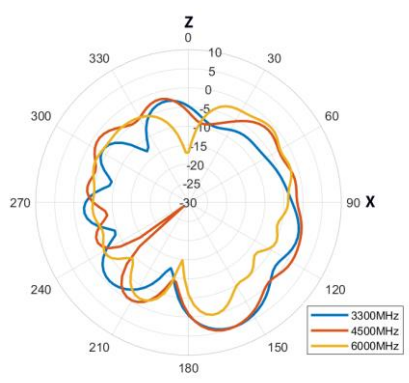
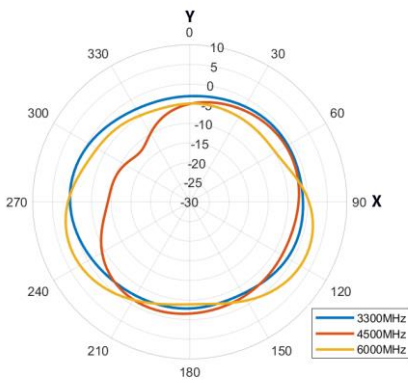

5. Mechanical Drawing (Units: mm)

5.1 Antenna Drawing

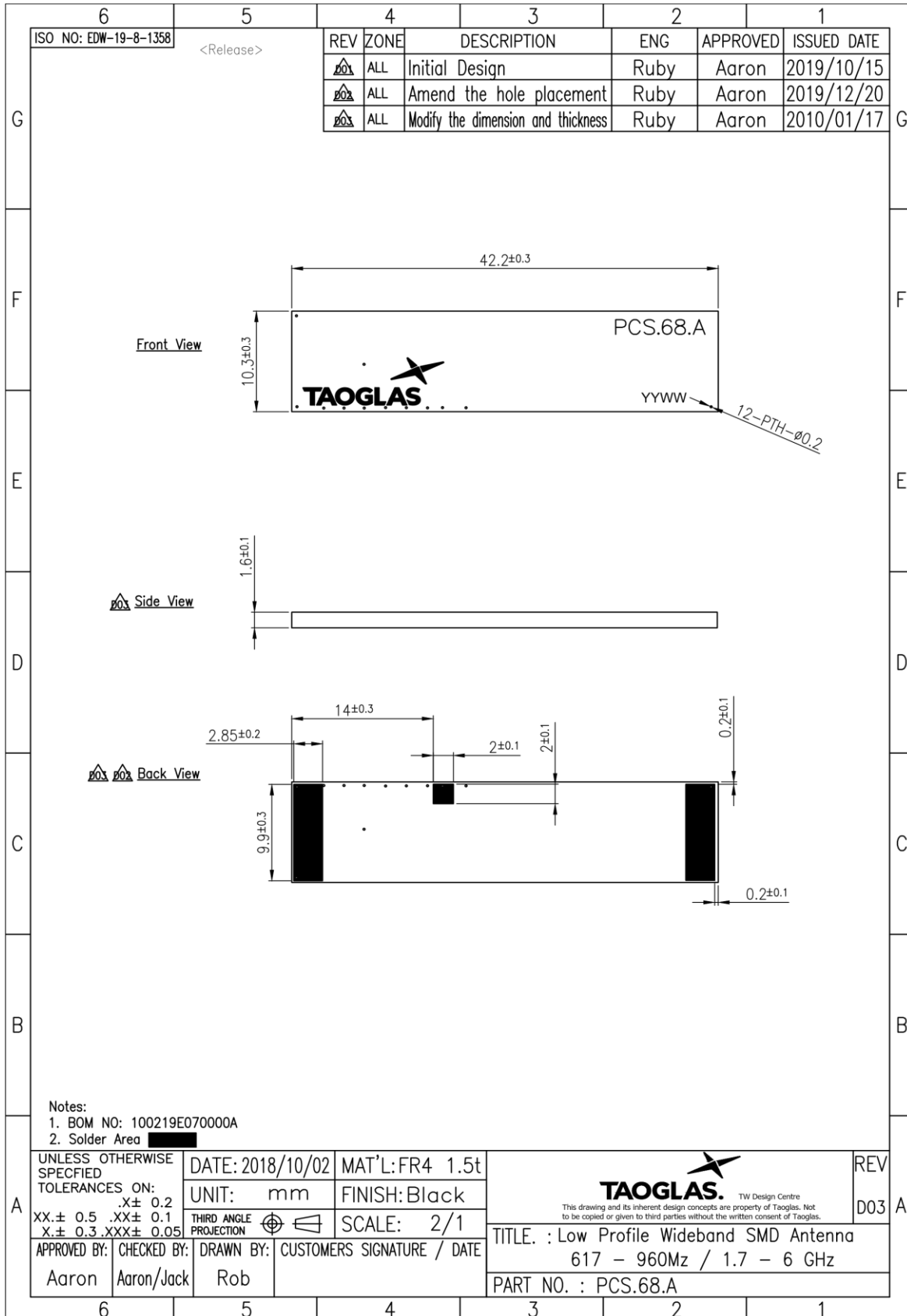

Notes:
 1. BOM NO: 100219E070000A
 2. Solder Area XXXXXXXXXX

UNLESS OTHERWISE SPECIFIED TOLERANCES ON: XX.± 0.5 .XX± 0.1 X.± 0.3 .XXX± 0.05	DATE: 2018/10/02	MAT'L: FR4 1.5t	TW Design Centre <small>This drawing and its inherent design concepts are property of Taoglas. Not to be copied or given to third parties without the written consent of Taoglas.</small>	REV
	UNIT: mm	FINISH: Black		D03
THIRD ANGLE PROJECTION	SCALE: 2/1		TITLE. : Low Profile Wideband SMD Antenna 617 - 960Mz / 1.7 - 6 GHz PART NO. : PCS.68.A	
APPROVED BY: Aaron	CHECKED BY: Aaron/Jack	DRAWN BY: Rob		

5.2 Evaluation Board Drawing

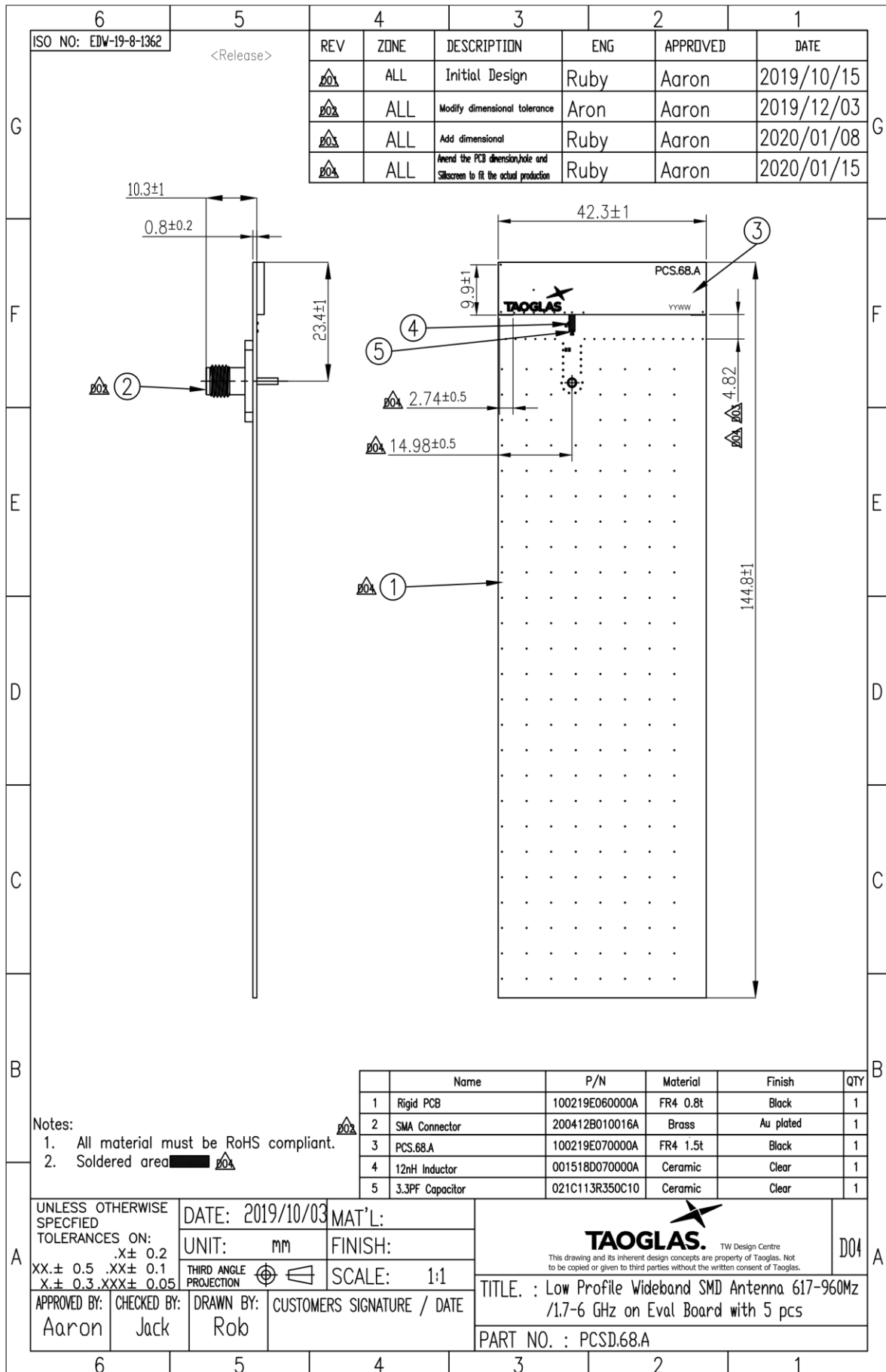

6. Matching Circuit

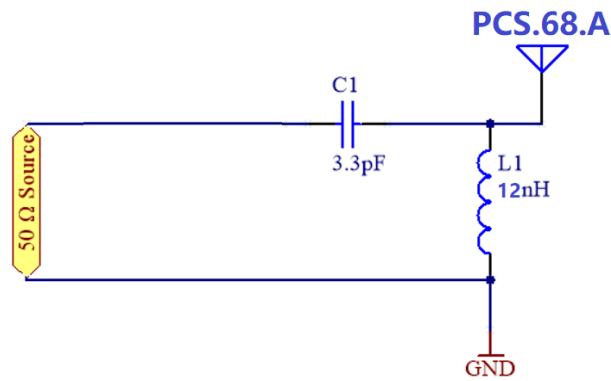

Circuit Symbol	Size	Description
L1	0402	12nH inductor (TDK MLK1005S12NJ)
C1	0402	3.3pF Capacitor (CRM0335C1E3R3CD01)

7. Packaging

800 pcs PCS.68.A per Tape & Reel
 Dimensions: 330*330*60mm
 Weight: 2.5Kg

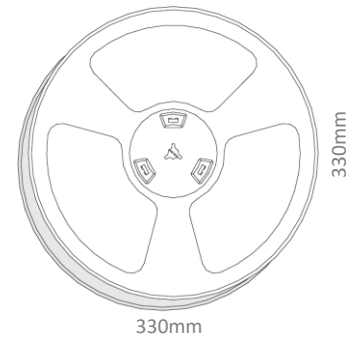
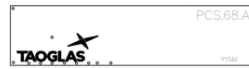

1 reel in small inner box
 Dimensions: 350*350*70mm
 Weight: 2.6Kg

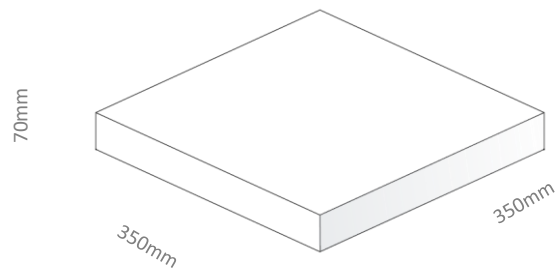

2400 pcs in one carton
 Dimensions: 370*360*275mm
 Weight: 8Kg

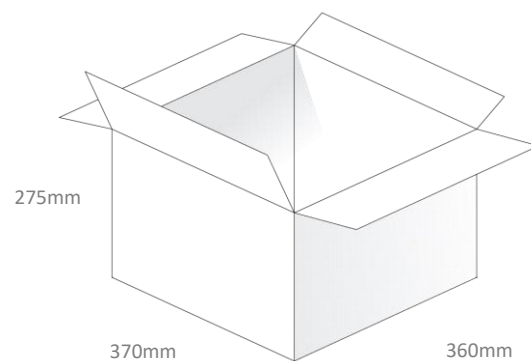

Pallet Dimensions:
 1200*1320*1000mm
 24 Cartons Per Pallet
 6 Cartons Per Layer
 4 Layers

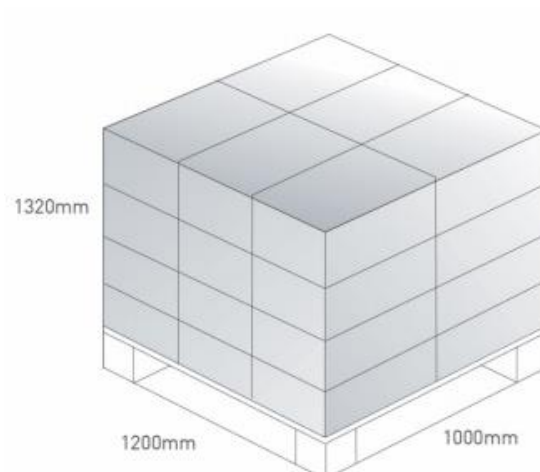

Changelog for the datasheet

SPE-19-8-129 – PCS.68.A

Revision: D (Current Version)

Date:	2020-03-06
Notes:	Updated drawing and pictures
Author:	Jack Conroy

Previous Revisions

Revision: C

Date:	2020-01-02
Notes:	Updated Packaging
Author:	Jack Conroy

Revision: B

Date:	2019-12-11
Notes:	Updated Packaging
Author:	Jack Conroy

Revision: A (Original Release)

Date:	2019-10-17
Notes:	Initial Datasheet Release
Author:	Yu Kai Yeung



TAOGLAS®

www.taoglas.com

