

G3VM-□CR□/□FR□

MOS FET Relays DIP 8-pin, High-Current and Low-ON-resistance Type

The highest class load current of MOS FET Relays realized with DIP8 package

- Contact form: 1a (SPST-NO)
- Load voltage: 60 V, 400 V, or 600 V
- 60-V Relay: Continuous load current of 5 A (10 A) max. *
- 600-V Relay: Continuous load current of 0.6 A (1.2 A) max. *

* Values in parentheses are for connection C.



NEW

Note: The actual product is marked differently from the image shown here.

RoHS Compliant

Application Examples

- Communication equipment
- Test & Measurement equipment
- Security equipment
- Industrial equipment
- Power circuit

Package (Unit : mm, Average)

DIP 8-pin
PCB Terminals

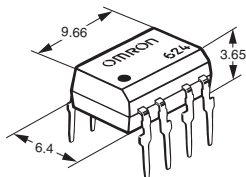

Surface-mounting Terminals

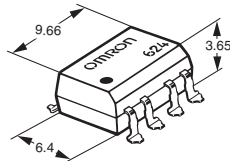

Note: The actual product is marked differently from the image shown here.

Model Number Legend

G3VM-□□□□□
1 2 3 4 5

1. Load Voltage

6 : 60 V
40 : 400 V
60 : 600 V

2. Contact form

1 : 1a (SPST-NO)

3. Package

C : DIP 8-pin with PCB terminals
F : DIP 8-pin with surface-mounting terminals

4. Additional functions

R: Low ON resistance

5. Other informations

When specifications overlap, serial code is added in the recorded order.

Ordering Information

Package	Contact form	Load voltage (peak value) *	Continuous load current (peak value) *	Stick packaging		Minimum package quantity	Tape packaging	
				Model			Model	Minimum package quantity
				PCB Terminals	Surface-mounting Terminals			
DIP8	1a (SPST-NO)	60 V	5 A	G3VM-61CR1	G3VM-61FR1	50 pcs.	G3VM-61FR1(TR05)	500 pcs.
		400 V	0.4 A	G3VM-401CR	G3VM-401FR		G3VM-401FR(TR05)	
		600 V	0.6 A	G3VM-601CR	G3VM-601FR		G3VM-601FR(TR05)	

* The AC peak and DC value are given for the load voltage and continuous load current.

Note: To order tape packaging for Relays with surface-mounting terminals, add "(TR05)" to the end of the model number.

■ Absolute Maximum Ratings (Ta = 25°C)

Item		Symbol	G3VM-61CR1 G3VM-61FR1	G3VM-401CR G3VM-401FR	G3VM-601CR G3VM-601FR	Unit	Measurement conditions	
Input	LED forward current	IF	30			mA		
	Repetitive peak LED forward current	IFP	1			A	100 μs pulses, 100 pps	
	LED forward current reduction rate	ΔIF/°C	-0.3			mA/°C	Ta ≥ 25°C	
	LED reverse voltage	VR	5			V		
	Connection temperature	TJ	125			°C		
Load voltage (AC peak/DC)		V _{OFF}	60	400	600	V		
Output	Continuous load current	Connection A	5	0.4	0.6	A	Connection A: AC peak/DC Connection B and C: DC	
		Connection B	5	0.4	0.6			
		Connection C	10	0.8	1.2			
	ON current reduction rate	Connection A	ΔI _o /°C	-50	-4	-6	mA/°C	Ta ≥ 25°C
		Connection B		-50	-4	-6		
		Connection C		-100	-8	-12		
Pulse ON current		I _{op}	15	1.2	1.8	A	t=100 ms, Duty=1/10	
Connection temperature		TJ	125			°C		
Dielectric strength between I/O (See note 1.)		V _{I-O}	2,500			V _{rms}	AC for 1 min	
Ambient operating temperature		Ta	-40 to +85			°C		
Ambient storage temperature		T _{stg}	-55 to +125			°C	With no icing or condensation	
Soldering temperature		-	260			°C	10 s	

Note: 1. The dielectric strength between the input and output was checked by applying voltage between all pins as a group on the LED side and all pins as a group on the light-receiving side.

Connection Diagram

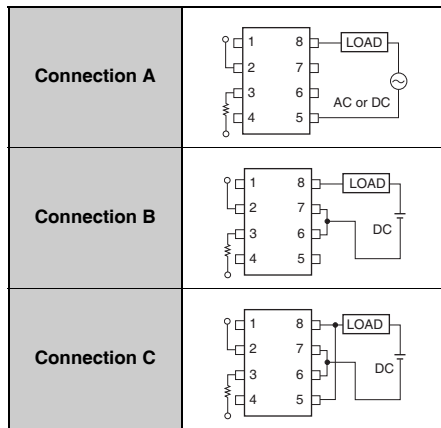

■Electrical Characteristics (Ta = 25°C)

Item	Symbol	G3VM-61CR1 G3VM-61FR1			G3VM-401CR G3VM-401FR		G3VM-601CR G3VM-601FR		Unit	Measurement conditions
LED forward voltage	V _F	Minimum	1.5			V	I _F =10 mA			
		Typical	1.64							
		Maximum	1.8							
Reverse current	I _R	Maximum	10			μA	V _R =5 V			
Capacitance between terminals	C _T	Typical	70			pF	V=0, f=1MHz			
Trigger LED forward current	I _{FT}	Typical	0.28	0.2	0.23	mA	G3VM-61CR1/FR1 : I _o =1 A G3VM-401CR/FR : I _o =0.4 A G3VM-601CR/FR : I _o =0.6 A			
		Maximum	5	1	5					
Release LED forward current	I _{FC}	Minimum	0.01			mA	G3VM-61CR1/FR1 : I _{OFF} =1 μA G3VM-401CR/FR : I _{OFF} =10 μA G3VM-601CR/FR : I _{OFF} =1 μA			
		Typical	0.19		0.17					
Maximum resistance with output ON	R _{ON}	Typical	0.022	3	1.3	Ω	G3VM-61CR1/FR1 : I _o =1 A, I _F =5 mA, t < 1 s G3VM-401CR/FR : I _o =0.4 A, I _F =2 mA, t < 1 s G3VM-601CR/FR : I _o =0.6 A, I _F =5 mA, t < 1 s			
		Maximum	0.05	5	2					
		Maximum	0.025	2.5	1					
Current leakage when the relay is open	I _{LEAK}	Typical	0.01	0.001	0.05	μA	V _{OFF} =Load Voltage Ratings			
		Maximum	10	1	10					
Capacitance between terminals	C _{OFF}	Typical	850	410	4,300	pF	V=0, f=1 MHz			
Capacitance between I/O terminals	C _{I-O}	Typical	0.8			pF	f=1 MHz, V _s =0 V			
Insulation resistance between I/O terminals	R _{I-O}	Minimum	1,000			MΩ	V _{I-O} =500 VDC, R _{OH} =60%			
		Typical	10 ⁸							
Turn-ON time	t _{ON}	Typical	2.5	0.22	0.8	ms	I _F = 5 mA, R _L = 200 Ω, V _{DD} = 20 V (See note 2.)			
		Maximum	5	1	3					
Turn-OFF time	t _{OFF}	Typical	0.1	0.08	0.07	ms	I _F = 5 mA, R _L = 200 Ω, V _{DD} = 20 V (See note 2.)			
		Maximum	1							

Note: 2. Turn-ON and Turn-OFF Times

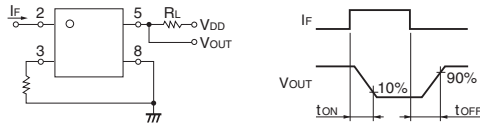

■Recommended Operating Conditions

For usage with high reliability, Recommended Operation Conditions is a measure that takes into account the derating of Absolute Maximum Ratings and Electrical Characteristics.

Each item on this list is an independent condition, so it is not simultaneously satisfy several conditions.

Item	Symbol	Symbol	G3VM-61CR1 G3VM-61FR1	G3VM-401CR G3VM-401FR	G3VM-601CR G3VM-601FR	Unit
Load voltage (AC peak/DC)	V _{DD}	Maximum	48	320	480	V
Operating LED forward current	I _F	Typical	5	2	5	mA
		Maximum	25			
Continuous load current (AC peak/DC)	I _o	Maximum	5	0.4	0.6	A
Ambient operating temperature	T _a	Minimum	-40			°C
		Maximum	85			

■Spacing and Insulation

Item	Minimum	Unit
Creepage distances	7.0	mm
Clearance distances	7.0	
Internal isolation thickness	0.4	

Engineering Data

LED forward current vs. Ambient temperature

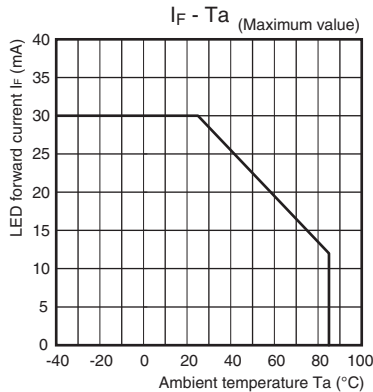

Continuous load current vs. Ambient temperature

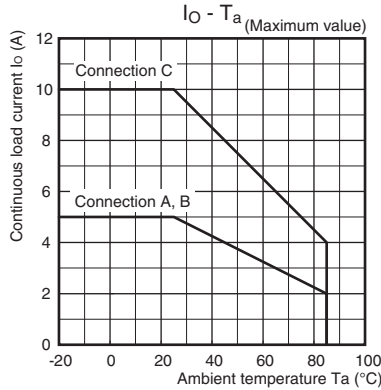

G3VM-401CR/401FR/601CR/601FR

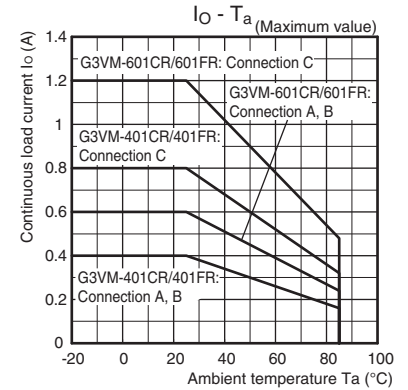

LED forward current vs. LED forward voltage

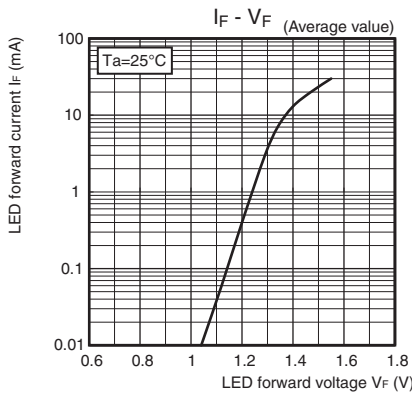

Continuous load current vs. On-state voltage

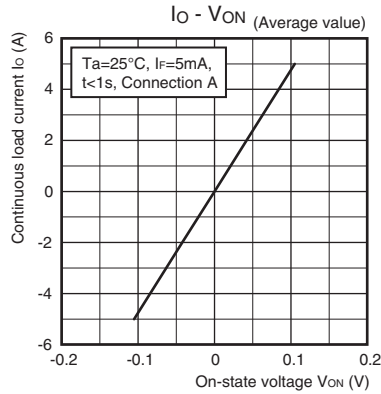

G3VM-401CR/401FR/601CR/601FR

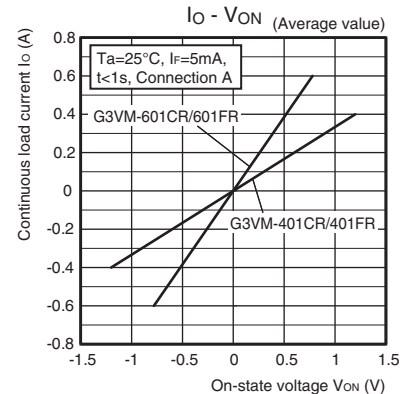

On-state resistance vs. Ambient temperature

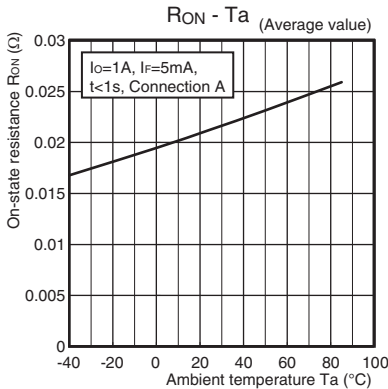

G3VM-401CR/401FR/601CR/601FR

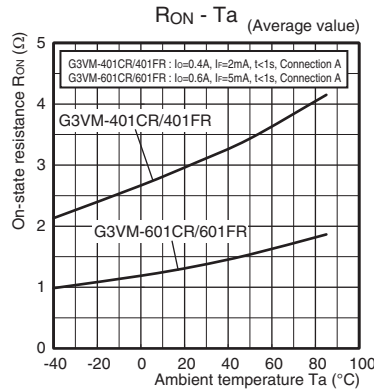

Trigger LED forward current vs. Ambient temperature

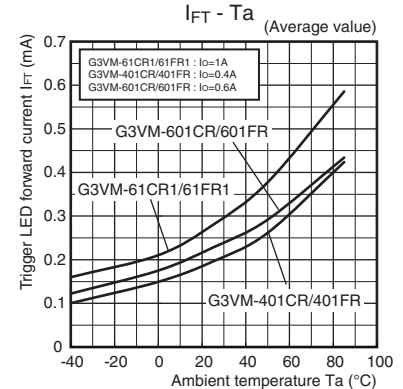

Turn ON, Turn OFF time vs. LED forward current

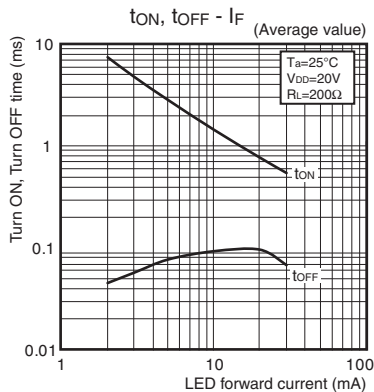

G3VM-401CR/401FR/601CR/601FR

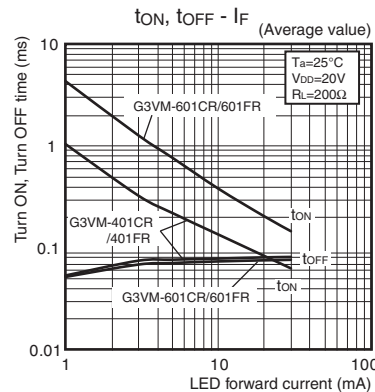

DIP G3VM-□CR□/□FR□

Engineering Data

● Turn ON, Turn OFF time vs. Ambient temperature G3VM-61CR1/61FR1

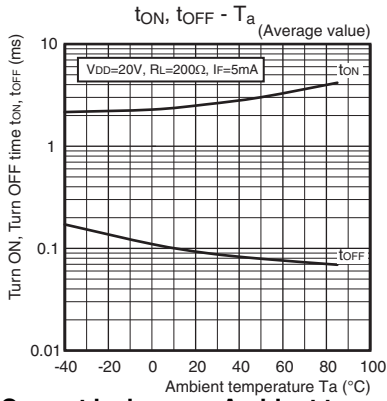

G3VM-401CR/401FR/601CR/601FR

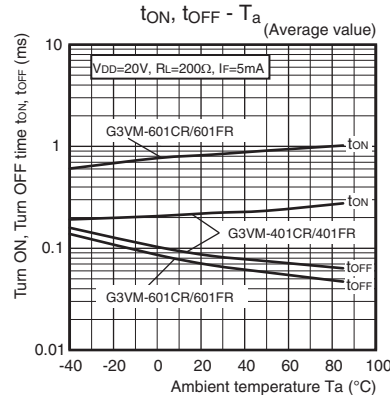

● Current leakage vs. Ambient temperature

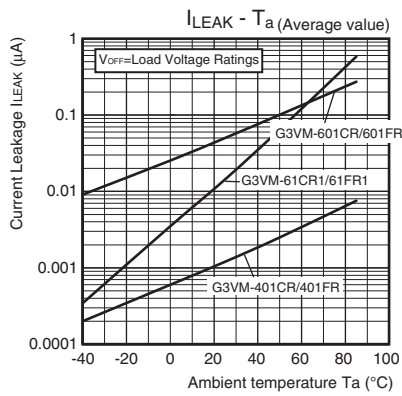

DIP

G3VM-□CR□/□FR□

■Appearance / Terminal Arrangement / Internal Connections

●Appearance

DIP (Dual Inline Package)

DIP 8-pin

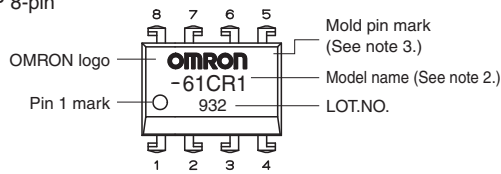

●Terminal Arrangement/Internal Connections (Top View)

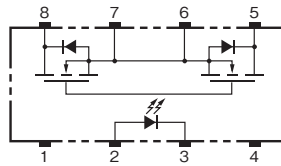

- Note: 1.** The actual product is marked differently from the image shown here.
- Note: 2.** "G3VM" does not appear in the model number on the Relay.
- Note: 3.** The indentation in the corner diagonally opposite from the pin 1 mark is from a pin on the mold.

■Dimensions (Unit: mm)

DIP 8-pin



PCB Terminals

Weight: 0.54 g

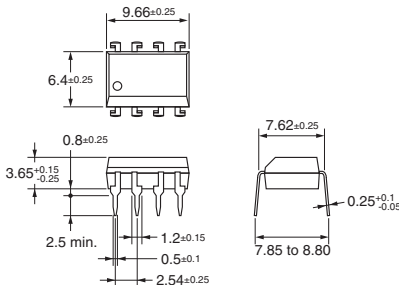

Surface-mounting Terminals

Weight: 0.54 g

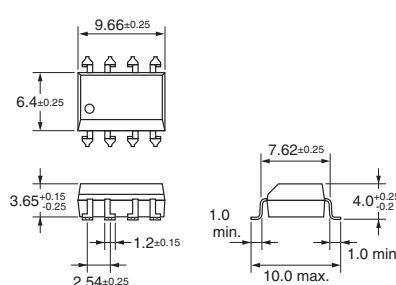

PCB Dimensions (BOTTOM VIEW)

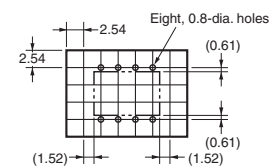

Actual Mounting Pad Dimensions

(Recommended Value, Top View)

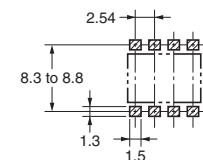

Note: The actual product is marked differently from the image shown here.

■Approved Standards

UL recognized

Model	Approved Standards	Contact form	File No.
G3VM-61CR1 G3VM-61FR1	Applying for UL recognition		
G3VM-401CR G3VM-401FR			
G3VM-601CR G3VM-601FR			

■Safety Precautions

- Refer to the *Common Precautions for All MOS FET Relays* for precautions that apply to all MOS FET Relays.

• Application examples provided in this document are for reference only. In actual applications, confirm equipment functions and safety before using the product.
 • Consult your OMRON representative before using the product under conditions which are not described in the manual or applying the product to nuclear control systems, railroad systems, aviation systems, vehicles, combustion systems, medical equipment, amusement machines, safety equipment, and other systems or equipment that may have a serious influence on lives and property if used improperly. Make sure that the ratings and performance characteristics of the product provide a margin of safety for the system or equipment, and be sure to provide the system or equipment with double safety mechanisms.

Note: Do not use this document to operate the Unit.