

# NVMFS5A160PLZ

## MOSFET – Power, Single P-Channel

**-60 V, -100 A, 7.7 mΩ**



**ON Semiconductor®**

[www.onsemi.com](http://www.onsemi.com)

### Features

- Small Footprint (5 x 6 mm) for Compact Design
- Low  $R_{DS(on)}$  to Minimize Conduction Losses
- NVMFS5A160PLZWF: Wettable Flank Option for Enhanced Optical Inspection
- AEC-Q101 Qualified and PPAP Capable
- These Devices are Pb-Free and are RoHS Compliant

### SPECIFICATION MAXIMUM RATINGS ( $T_J = 25^\circ\text{C}$ unless otherwise noted) (Notes 1, 2, 3)

Symbol	Parameter		Value	Unit	
$V_{DSS}$	Drain to Source Voltage		-60	V	
$V_{GS}$	Gate to Source Voltage		$\pm 20$	V	
$I_D$	Continuous Drain, Current $R_{\theta JC}$ , (Notes 1, 3)	Steady State	$T_C = 25^\circ\text{C}$	-100	A
$P_D$			Power Dissipation $R_{\theta JC}$ (Note 1)	$T_C = 25^\circ\text{C}$	200
$I_D$	Continuous Drain: Current $R_{\theta JA}$ (Notes 1, 2, 3)	Steady State	$T_A = 25^\circ\text{C}$	-15	A
$P_D$			Power Dissipation $R_{\theta JA}$ (Note 1, 2)	$T_A = 25^\circ\text{C}$	3.8
$I_{DP}$	Pulsed Drain Current	$PW \leq 10 \mu\text{s}$ , duty cycle $\leq 1\%$	-400	A	
$T_J, T_{STG}$	Operating Junction and Storage Temperature		-55 to +175	$^\circ\text{C}$	
$I_S$	Source Current (Body Diode)		-100	A	
$E_{AS}$	Single Pulse Drain to Source Avalanche Energy ( $L = 1.0 \text{ mH}$ , $I_{L(pk)} = -26 \text{ A}$ )		335	mJ	
$T_L$	Lead Temperature for Soldering Purposes (1/8" from case for 10 s)		260	$^\circ\text{C}$	

Stresses exceeding those listed in the Maximum Ratings table may damage the device. If any of these limits are exceeded, device functionality should not be assumed, damage may occur and reliability may be affected.

### THERMAL CHARACTERISTICS

Symbol	Parameter	Value	Unit
$R_{\theta JC}$	Junction to Case Steady State	0.75	$^\circ\text{C/W}$
$R_{\theta JA}$	Junction to Ambient Steady State (Note 3)	39	

1. The entire application environment impacts the thermal resistance values shown, they are not constants and are only valid for the particular conditions noted.
2. Surface mounted on FR4 board using a 650 mm<sup>2</sup>, 2 oz. Cu pad.
3. Maximum current for pulses as long as 1 second is higher but is dependent on pulse duration and duty cycle.

$V_{DSS}$	$R_{DS(ON)} \text{ MAX}$	$I_D \text{ MAX}$
-60 V	7.7 mΩ @ -10 V	-100 A
	10.5 mΩ @ -4.5 V	

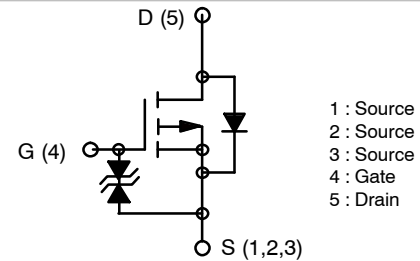

**P-CHANNEL MOSFET**

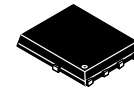

**DFN5 (SO-8FL)**

### MARKING DIAGRAM

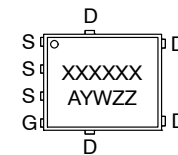

- XXXXXX = Specific Device Code  
5A160L(NVMFS5A160PLZ)  
160LWF(NVMFS5A160PLZWF)
- A = Assembly Location
- Y = Year
- W = Work Week
- ZZ = Lot Traceability

### ORDERING INFORMATION

See detailed ordering and shipping information on page 7 of this data sheet.

# NVMFS5A160PLZ

## ELECTRICAL CHARACTERISTICS (T<sub>J</sub> = 25°C unless otherwise noted)

Symbol	Parameter	Test Condition	Min	Typ	Max	Unit
<b>OFF CHARACTERISTICS</b>						
V <sub>(BR)DSS</sub>	Drain to Source Breakdown Voltage	I <sub>D</sub> = -1 mA, V <sub>GS</sub> = 0 V	-60			V
I <sub>DSS</sub>	Zero Gate Voltage Drain Current	V <sub>DS</sub> = -60 V, V <sub>GS</sub> = 0 V	T <sub>J</sub> = 25°C		-1.0	μA
			T <sub>J</sub> = 100°C (Note 4)		-100	μA
I <sub>GSS</sub>	Gate to Source Leakage Current	V <sub>GS</sub> = ±16 V, V <sub>DS</sub> = 0 V			±10	μA

## ON CHARACTERISTICS (Note 5)

V <sub>GS(th)</sub>	Gate Threshold Voltage	V <sub>DS</sub> = -10 V, I <sub>D</sub> = -1 mA	-1.2		-2.6	V
R <sub>DS(on)</sub>	Drain to Source On Resistance	V <sub>GS</sub> = -10 V	I <sub>D</sub> = -50 A	5.8	7.7	mΩ
		V <sub>GS</sub> = -4.5 V	I <sub>D</sub> = -50 A	7.3	10.5	
g <sub>FS</sub>	Forward Transconductance	V <sub>DS</sub> = -10 V, I <sub>D</sub> = -50 A		119		S

## CHARGES, CAPACITANCES & GATE RESISTANCE

C <sub>iss</sub>	Input Capacitance	V <sub>GS</sub> = 0 V, f = 1 MHz V <sub>DS</sub> = -20 V,			7700	pF
C <sub>oss</sub>	Output Capacitance				720	
C <sub>rss</sub>	Reverse Transfer Capacitance				540	
Q <sub>g(tot)</sub>	Total Gate Charge	V <sub>GS</sub> = -10 V, I <sub>D</sub> = -50 A V <sub>DS</sub> = -36 V,			160	nC
Q <sub>gs</sub>	Gate to Source Charge				24	
Q <sub>gd</sub>	Gate to Drain Charge				45	

## SWITCHING CHARACTERISTICS (Note 6)

t <sub>d(on)</sub>	Turn-On Delay Time	V <sub>DS</sub> = -36 V, I <sub>D</sub> = -50 A, V <sub>GS</sub> = -10 V, R <sub>G</sub> = 50 Ω			50	ns
t <sub>r</sub>	Rise Time				690	
t <sub>d(off)</sub>	Turn-Off Delay Time				645	
t <sub>f</sub>	Fall Time				643	

## DRAIN-SOURCE DIODE CHARACTERISTICS

V <sub>SD</sub>	Forward Diode Voltage	V <sub>GS</sub> = 0 V, I <sub>S</sub> = -50 A			-0.83	-1.5	V
t <sub>rr</sub>	Reverse Recovery Time	V <sub>GS</sub> = 0 V, I <sub>S</sub> = -50 A			93		ns
Q <sub>rr</sub>	Reverse Recovery Charge	di/dt = 100 A/μs			218		nC

Product parametric performance is indicated in the Electrical Characteristics for the listed test conditions, unless otherwise noted. Product performance may not be indicated by the Electrical Characteristics if operated under different conditions.

4. The maximum value is specified by design at T<sub>J</sub> = 100 °C. Product is not tested to this condition in production.

5. Pulse Test: pulse width ≤ 300μs, duty cycle ≤ 2%.

6. Switching characteristics are independent of operating junction temperatures.

TYPICAL CHARACTERISTICS

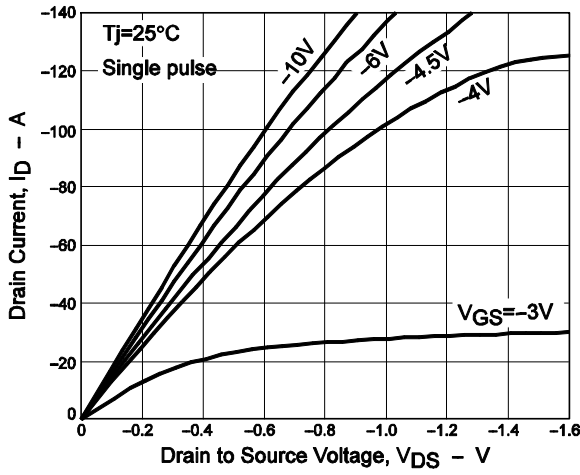

Figure 1.  $I_D - V_{DS}$

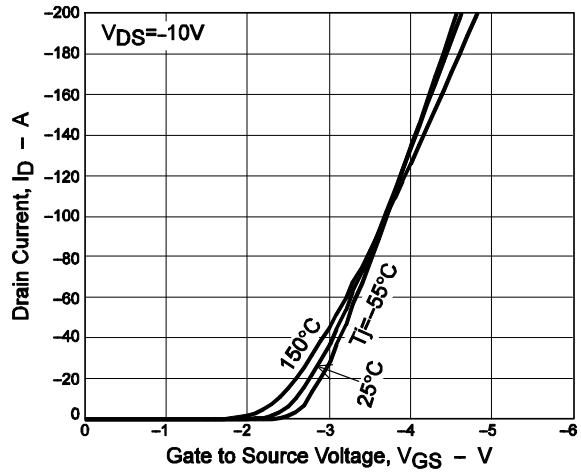

Figure 2.  $I_D - V_{GS}$

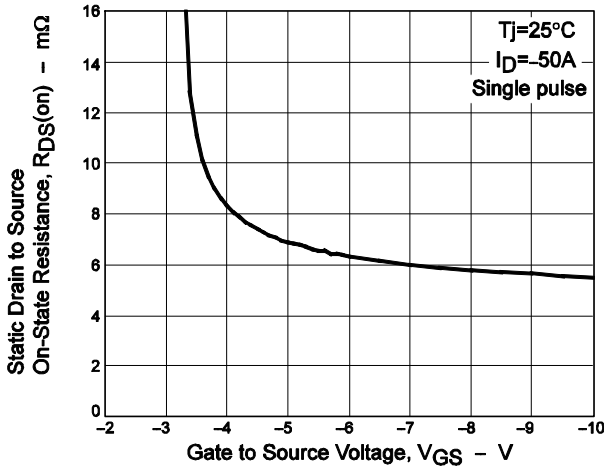

Figure 3.  $R_{DS(on)} - V_{GS}$

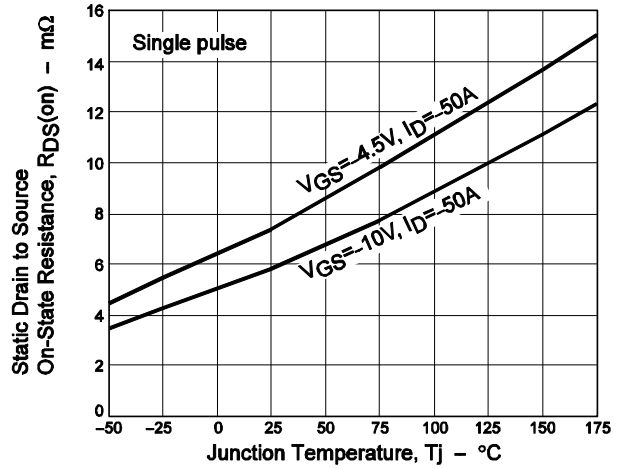

Figure 4.  $R_{DS(on)} - T_J$

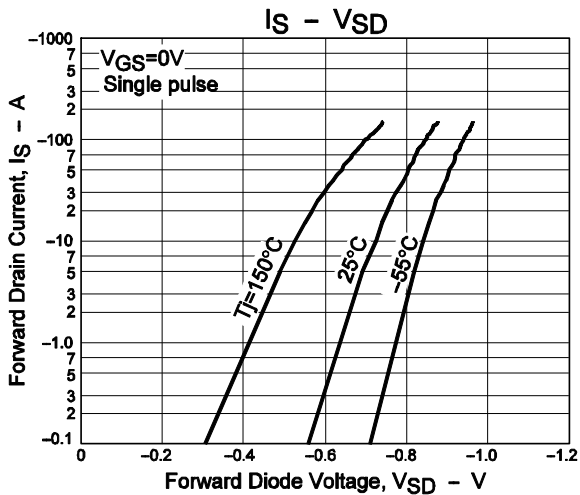

Figure 5.  $I_S - V_{SD}$

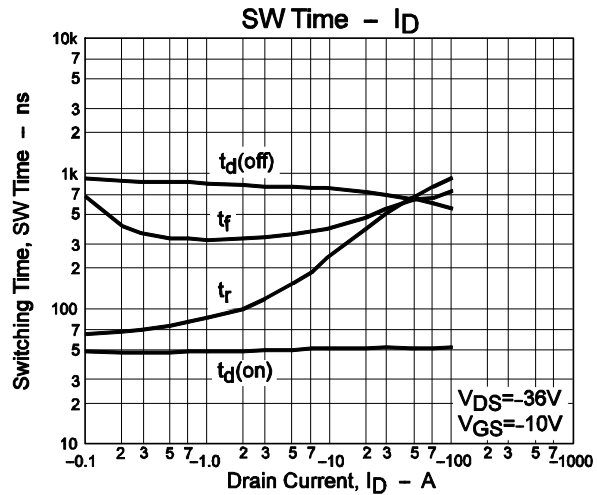

Figure 6. SW Time -  $I_D$

# NVMFS5A160PLZ

## TYPICAL CHARACTERISTICS

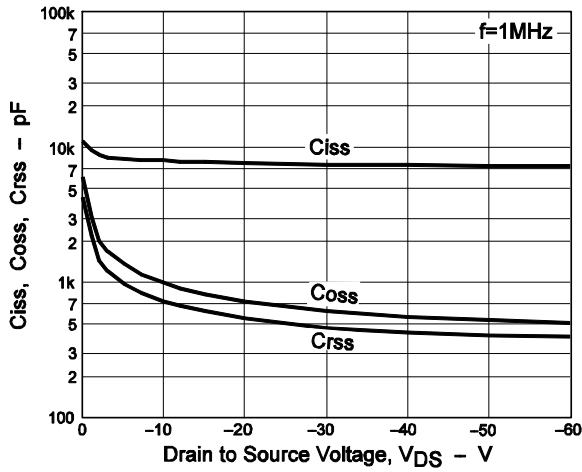

Figure 7.  $C_{iss}$ ,  $C_{oss}$ ,  $C_{rss}$  -  $V_{DS}$

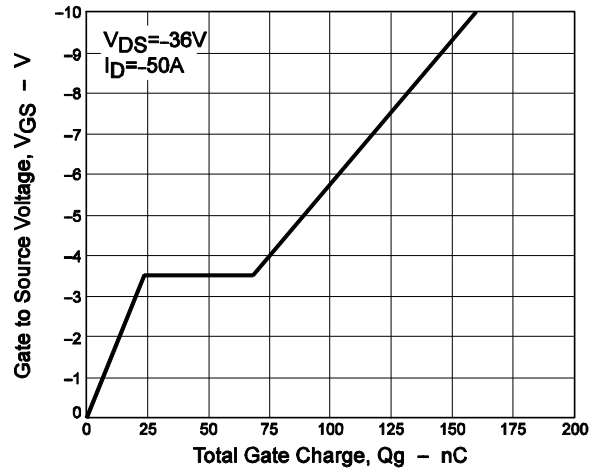

Figure 8.  $V_{GS}$  -  $Q_g$

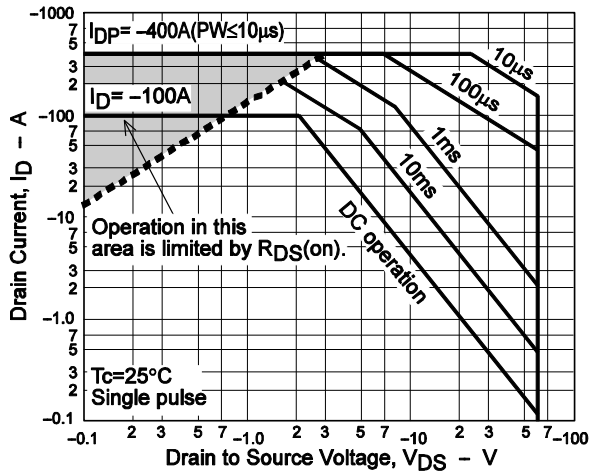

Figure 9. SOA

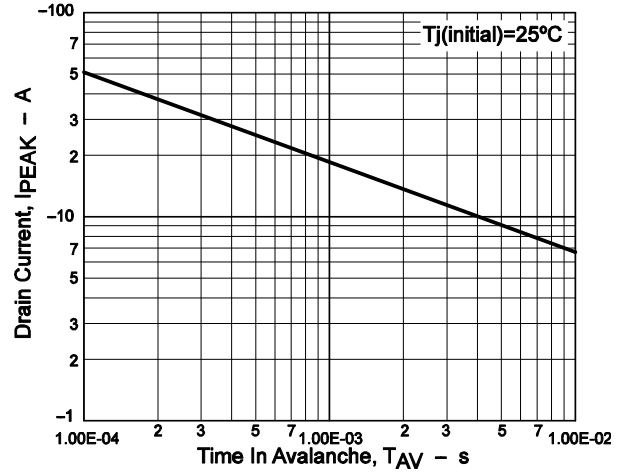

Figure 10.  $I_{PEAK}$  -  $T_{AV}$

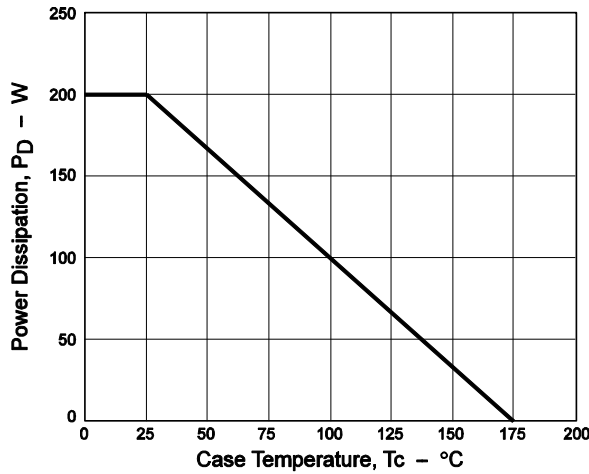

Figure 11.  $P_D$  -  $T_c$

# NVMFS5A160PLZ

## TYPICAL CHARACTERISTICS

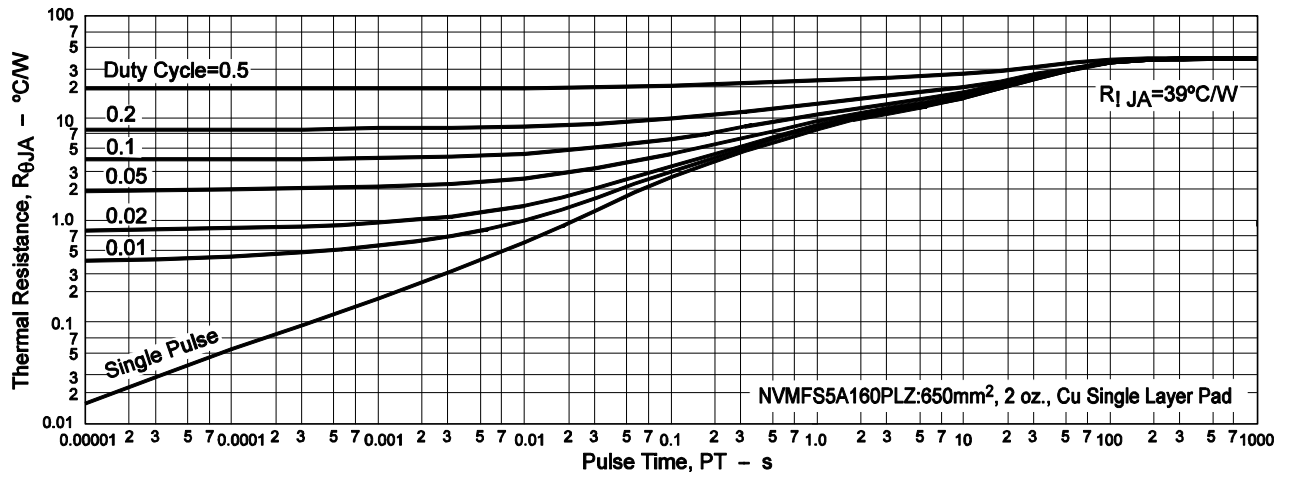
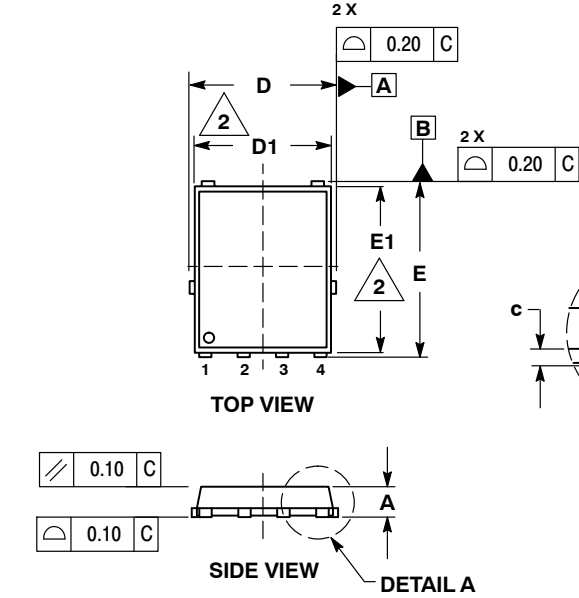

Figure 12.  $R_{\theta JA}$  - Pulse Time

# NVMFS5A160PLZ

DFN5 5x6, 1.27P  
(SO-8FL)  
CASE 488AA  
ISSUE M



**NOTES:**

1. DIMENSIONING AND TOLERANCING PER ASME Y14.5M, 1994.
2. CONTROLLING DIMENSION: MILLIMETER.
3. DIMENSION D1 AND E1 DO NOT INCLUDE MOLD FLASH PROTRUSIONS OR GATE BURRS.

MILLIMETERS			
DIM	MIN	NOM	MAX
A	0.90	1.00	1.10
A1	0.00	---	0.05
b	0.33	0.41	0.51
c	0.23	0.28	0.33
D	5.00	5.15	5.30
D1	4.70	4.90	5.10
D2	3.80	4.00	4.20
E	6.00	6.15	6.30
E1	5.70	5.90	6.10
E2	3.45	3.65	3.85
e	1.27 BSC		
G	0.51	0.575	0.71
K	1.20	1.35	1.50
L	0.51	0.575	0.71
L1	0.125 REF		
M	3.00	3.40	3.80
θ	0°	---	12°

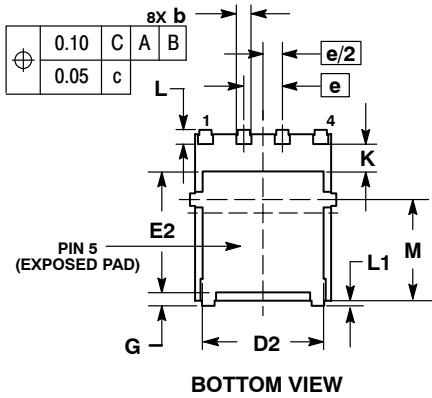

**RECOMMENDED SOLDERING FOOTPRINT\***

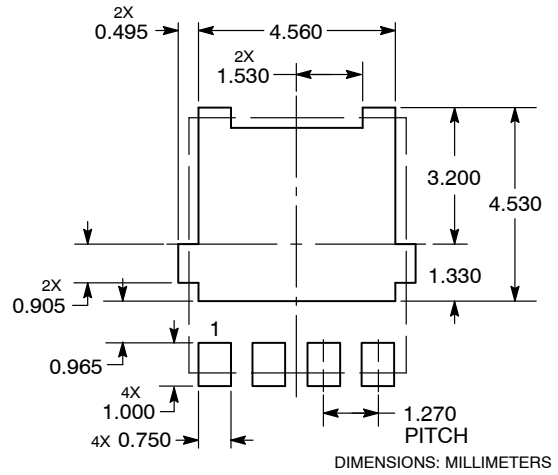

**STYLE 1:**

- PIN 1. SOURCE
- SOURCE
- SOURCE
- GATE
- DRAIN

# NVMFS5A160PLZ

## ORDERING INFORMATION

Device	Marking	Package	Shipping (Qty / Packing) <sup>†</sup>
NVMFS5A160PLZT1G	5A160L	DFN5 5x6, 1.27P (SO-8FL) (Pb-Free)	1.500 / Tape & Reel
NVMFS5A160PLZWFT1G	160LWF	DFN5 5x6, 1.27P (SO-8FL) (Pb-Free, Wettable Flanks)	1.500 / Tape & Reel
NVMFS5A160PLZT3G	5A160L	DFN5 5x6, 1.27P (SO-8FL) (Pb-Free)	5.000 / Tape & Reel
NVMFS5A160PLZWFT3G	160LWF	DFN5 5x6, 1.27P (SO-8FL) (Pb-Free, Wettable Flanks)	5.000 / Tape & Reel

<sup>†</sup>For information on tape and reel specifications, including part orientation and tape sizes, please refer to our Tape and Reel Packaging Specifications Brochure, BRD8011/D.

ON Semiconductor and  are trademarks of Semiconductor Components Industries, LLC dba ON Semiconductor or its subsidiaries in the United States and/or other countries. ON Semiconductor owns the rights to a number of patents, trademarks, copyrights, trade secrets, and other intellectual property. A listing of ON Semiconductor's product/patent coverage may be accessed at [www.onsemi.com/site/pdf/Patent-Marketing.pdf](http://www.onsemi.com/site/pdf/Patent-Marketing.pdf). ON Semiconductor reserves the right to make changes without further notice to any products herein. ON Semiconductor makes no warranty, representation or guarantee regarding the suitability of its products for any particular purpose, nor does ON Semiconductor assume any liability arising out of the application or use of any product or circuit, and specifically disclaims any and all liability, including without limitation special, consequential or incidental damages. Buyer is responsible for its products and applications using ON Semiconductor products, including compliance with all laws, regulations and safety requirements or standards, regardless of any support or applications information provided by ON Semiconductor. "Typical" parameters which may be provided in ON Semiconductor data sheets and/or specifications can and do vary in different applications and actual performance may vary over time. All operating parameters, including "Typicals" must be validated for each customer application by customer's technical experts. ON Semiconductor does not convey any license under its patent rights nor the rights of others. ON Semiconductor products are not designed, intended, or authorized for use as a critical component in life support systems or any FDA Class 3 medical devices or medical devices with a same or similar classification in a foreign jurisdiction or any devices intended for implantation in the human body. Should Buyer purchase or use ON Semiconductor products for any such unintended or unauthorized application, Buyer shall indemnify and hold ON Semiconductor and its officers, employees, subsidiaries, affiliates, and distributors harmless against all claims, costs, damages, and expenses, and reasonable attorney fees arising out of, directly or indirectly, any claim of personal injury or death associated with such unintended or unauthorized use, even if such claim alleges that ON Semiconductor was negligent regarding the design or manufacture of the part. ON Semiconductor is an Equal Opportunity/Affirmative Action Employer. This literature is subject to all applicable copyright laws and is not for resale in any manner.

## PUBLICATION ORDERING INFORMATION

### LITERATURE FULFILLMENT:

Literature Distribution Center for ON Semiconductor  
19521 E. 32nd Pkwy, Aurora, Colorado 80011 USA  
**Phone:** 303-675-2175 or 800-344-3860 Toll Free USA/Canada  
**Fax:** 303-675-2176 or 800-344-3867 Toll Free USA/Canada  
**Email:** [orderlit@onsemi.com](mailto:orderlit@onsemi.com)

**N. American Technical Support:** 800-282-9855 Toll Free  
USA/Canada  
**Europe, Middle East and Africa Technical Support:**  
Phone: 421 33 790 2910

**ON Semiconductor Website:** [www.onsemi.com](http://www.onsemi.com)

**Order Literature:** <http://www.onsemi.com/orderlit>

For additional information, please contact your local Sales Representative