

LQH43CN1R8M33#

"#" indicates a package specification code.



< List of part numbers with package codes >
LQH43CN1R8M33L

Shape

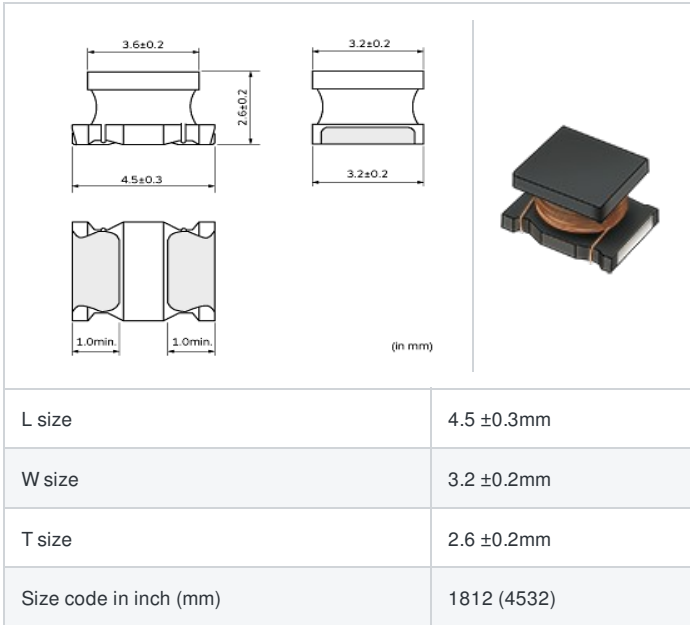

Notes

When rated current is applied to the products, inductance will be within ±20% of initial inductance value.
When rated current is applied to the products, the temperature rise caused by self-generated heat shall be limited to 40 °C max.

References

Packaging code	Specifications	Minimum quantity
L	φ 180mm Embossed taping	500

Mass (Typ.)	
1 piece	0.13g

Specifications

Inductance	1.8μH ±20%
Inductance test frequency	1MHz
Rated current (Itemp) (Based on Temperature rise)	2300mA
Max. of DC resistance	0.055Ω
Avg. of DC resistance	0.042Ω ±30%
Self resonance frequency (min.)	70MHz
Operating temperature range (Self-temperature rise is not included)	-40°C to 85°C
Class of magnetic shield	No Shield
Series	LQH43CN_33

Attention

- 1.This datasheet is downloaded from the website of Murata Manufacturing Co., Ltd. Therefore, it's specifications are subject to change or our products in it may be discontinued without advance notice. Please check with our sales representatives or product engineers before ordering.
- 2.This datasheet has only typical specifications because there is no space for detailed specifications. Therefore, please review our product specifications or consult the approval sheet for product specifications before ordering.

Chart of characteristic data (The charts below may show another part number which shares its characteristics.)

▪ Inductance-Current characteristics (Typ.)

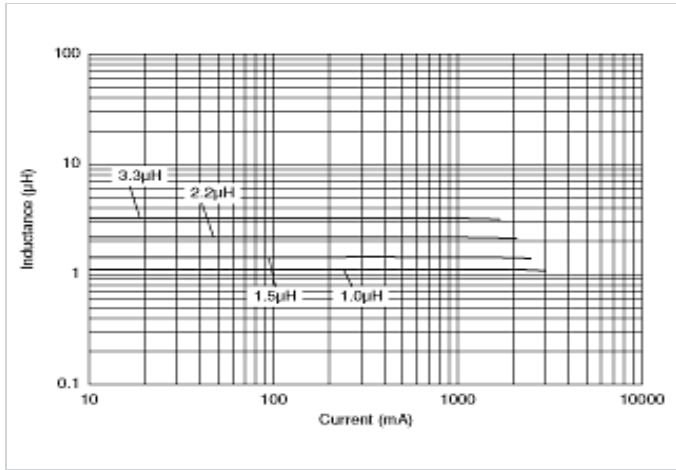

▪ Impedance-Frequency characteristics (Typ.)

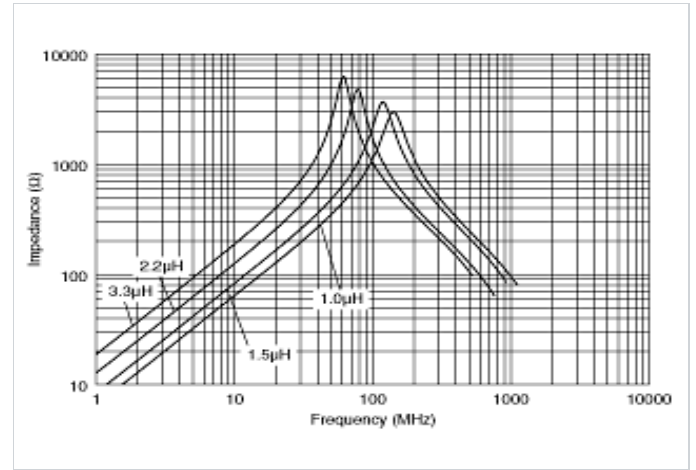

⚠ Attention

- 1.This datasheet is downloaded from the website of Murata Manufacturing Co., Ltd. Therefore, it's specifications are subject to change or our products in it may be discontinued without advance notice. Please check with our sales representatives or product engineers before ordering.
- 2.This datasheet has only typical specifications because there is no space for detailed specifications. Therefore, please review our product specifications or consult the approval sheet for product specifications before ordering.