



Q20AF200 Sensor with Background Suppression and IO- Link

Original Instructions

p/n: 208516 Rev. E

06-May-25

© Banner Engineering Corp. All rights reserved. www.bannerengineering.com

Contents

Chapter 1 Features	3
Models	3
Overview	3
Chapter 2 Installation Instructions	5
Sensor Orientation	5
Wiring	5
Set up the Q20 Sensor	5
IO-Link Interface	6
Chapter 3 Specifications	7
FCC Part 15 Class A for Unintentional Radiators	8
Industry Canada ICES-003(B)	8
Performance Curves	8
Excess Gain Curves	9
Dimensions	9
Chapter 4 Accessories	10
Quick-Disconnect (QD) Cordsets	10
Mounting Brackets	11
Chapter 5 Product Support and Maintenance	12
Clean Sensor with Compressed Air Then Isopropyl Alcohol	12
Repairs	12
Contact Us	12
Banner Engineering Corp Limited Warranty	12

Chapter Contents

Models 3
 Overview 3

Chapter 1 Features

The Q20 AF sensors are compact sensors featuring adjustable range background suppression mode.

- Photoelectric sensors in a compact, rugged, sealed, overmolded plastic housing
- Standard 3 mm threaded mounting holes on 25.4 mm (1 in) spacing
- Simple single-turn potentiometer adjustment of cutoff distance from 30 to 200 mm
- Enhanced immunity to fluorescent lights
- Crosstalk immunity algorithm allows two sensors to be used in close proximity
- High-intensity, bright red LED spot makes sensor alignment fast and easy
- Bright indicator LEDs show operating status from 360°
- Small bright red spot for reliable detection of colorfully printed packages and small parts or features



WARNING:



- **Do not use this device for personnel protection**
- Using this device for personnel protection could result in serious injury or death.
- This device does not include the self-checking redundant circuitry necessary to allow its use in personnel safety applications. A device failure or malfunction can cause either an energized (on) or de-energized (off) output condition.

Models

Model	Output Type	Sensing Range	Supply Voltage
Q20NAF200	Complementary NPN	Adjustable Cutoff: 30 mm to 200 mm	10 V DC to 30 V DC
Q20PAF200	Complementary PNP		
Q20KAF200Q7	IO-Link		

2 m (6.5 ft) PVC cabled models are listed for the complementary output models. 2 m (6.5 ft) and 9 m (30 ft) PVC cabled options are not available on IO-Link models.

- To order the 9 m (30 ft) PVC cable model, add the suffix "W/30" to the cabled model number. For example, Q20NAF200 W/30.
- To order the 4-pin M8 integral quick disconnect model, add the suffix "Q7" to the model number. For example, Q20NAF200Q7.
- To order the 150 mm (6 in) PVC cable model with a 4-pin M12 quick disconnect, add the suffix "Q5" to the model number. For example, Q20NAF200Q5.
- To order the 150 mm (6 in) PVC cable model with a 4-pin M8 quick disconnect, add the suffix "Q" to the model number. For example, Q20NAF200Q.
- Models with a quick disconnect require a mating cordset.

Overview

The WORLD-BEAM Q20 Sensor with Background Suppression and IO-Link detects targets within the cutoff distance while ignoring objects in the background.

Background suppression mode is recommended when the target position is repeatable, but target color and background conditions vary.

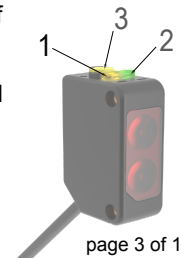

1. Green LED: Power indicator
2. Amber LED: Light sensed indicator (flashes for marginal conditions)
3. Cutoff point adjustment potentiometer

Chapter Contents

Sensor Orientation 5
 Wiring 5
 Set up the Q20 Sensor 5
 IO-Link Interface 6

Chapter 2 Installation Instructions

Sensor Orientation

Optimize detection reliability and minimum object separation performance with correct sensor-to-target orientation. To ensure reliable detection, orient the sensor as shown in relation to the target to be detected.

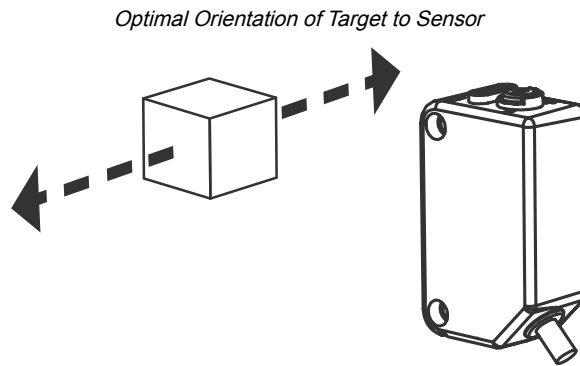

Wiring

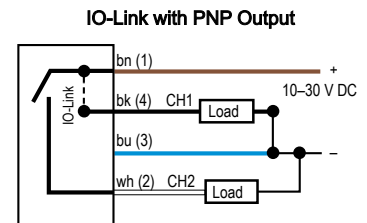
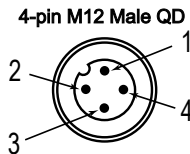
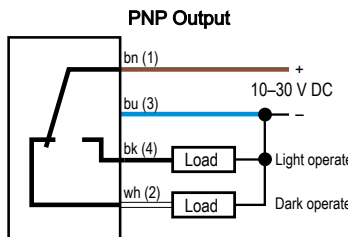
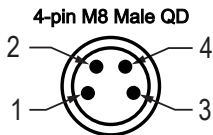
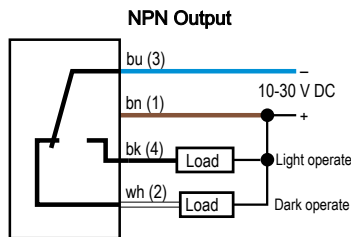

- 1 = Brown
- 2 = White
- 3 = Blue
- 4 = Black

Set up the Q20 Sensor

Background Suppression Mode: Objects beyond the set cutoff distance will not be detected. Background suppression mode can be used in most situations with varying object colors and positions or with varying background conditions.

To ensure reliable background suppression, a minimum separation distance between the object and the background is necessary.

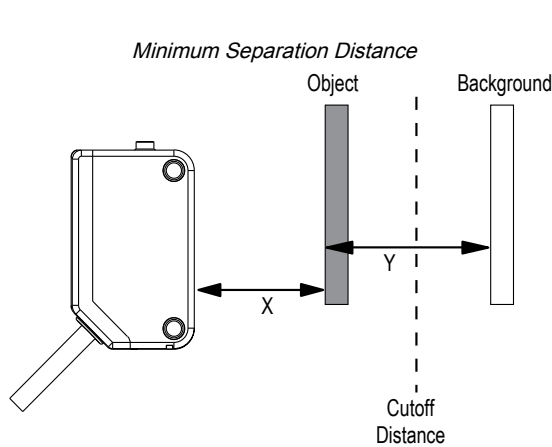

X: Distance to the Object

Y: Minimum Separation Between the Object and the Background

Set the cutoff distance approximately midway between the farthest object and the closest background.

1. Mount the sensor with the darkest object at the longest application distance.
The distance to the object must be less than shown in "Q20AF Performance Curves" on page 8 for your object color.
2. Turn the adjustment potentiometer counter-clockwise until the amber indicator turns off.
3. Turn the adjustment potentiometer clockwise until the amber indicator turns on.
4. Replace the darkest object with the brightest background at the closest application distance.
5. Turn the adjustment potentiometer clockwise until the amber indicator turns on.
6. Turn the adjustment potentiometer counter-clockwise approximately half of the adjustment rotation from the previous step.
This places the cutoff distance approximately half-way between the object and the background switch points. If sufficient separation exists between the object and background, the sensor is ready for operation.

IO-Link Interface

IO-Link is a point-to-point communication link between a master device and sensor. Use IO-Link to parameterize sensors and transmit process data automatically.

For the latest IO-Link protocol and specifications, see www.io-link.com.

Each IO-Link device has an IODD (IO Device Description) file that contains information about the manufacturer, article number, functionality etc. This information can be easily read and processed by the user. Each device can be unambiguously identified via the IODD as well as via an internal device ID. Download the Q20's IO-Link IODD package (p/n 209012) from Banner Engineering's website at www.bannerengineering.com.

Banner has also developed Add On Instruction (AOI) files to simplify ease-of-use between the Q20, multiple third-party vendors' IO-Link masters, and the Logix Designer software package for Rockwell Automation PLCs. Three types of AOI files for Rockwell Allen-Bradley PLCs are listed below. These files and more information can be found at www.bannerengineering.com.

Process Data AOIs—These files can be used alone, without the need for any other IO-Link AOIs. The job of a Process Data AOI is to intelligently parse out the Process Data word(s) in separate pieces of information. All that is required to make use of this AOI is an EtherNet/IP connection to the IO-Link Master and knowledge of where the Process Data registers are located for each port.

Parameter Data AOIs—These files require the use of an associated IO-Link Master AOI. The job of a Parameter Data AOI, when working in conjunction with the IO-Link Master AOI, is to provide quasi-realtime read/write access to all IO-Link parameter data in the sensor. Each Parameter Data AOI is specific to a given sensor or device.

IO-Link Master AOIs—These files require the use of one or more associated Parameter Data AOIs. The job of an IO-Link Master AOI is to translate the desired IO-Link read/write requests, made by the Parameter Data AOI, into the format a specific IO-Link Master requires. Each IO-Link Master AOI is customized for a given brand of IO-Link Master.

Add and configure the relevant Banner IO-Link Master AOI in your ladder logic program first; then add and configure Banner IO-Link Device AOIs as desired, linking them to the Master AOI as shown in the relevant AOI documentation.

Chapter Contents

FCC Part 15 Class A for Unintentional Radiators..... 8
 Industry Canada ICES-003(B)..... 8
 Performance Curves 8
 Excess Gain Curves..... 9
 Dimensions..... 9

Chapter 3 Specifications

Supply Voltage

10 V DC to 30 V DC (10% maximum ripple within specified limits)

Maximum Power Consumption (exclusive of load)

Less than 300 mW

Sensing Beam

Visible red LED, 640 nm

Supply Protection Circuitry

Protected against reverse polarity and transient voltages

Output Configuration

Solid-state complementary: open collector NPN or PNP, depending on model

Rating: 50 mA total output current ⁽¹⁾

Output Voltage High: Greater than Vsupply - 2.5 V

Output Voltage Low: Less than 2.5 V

For loads less than 1 Meg Ohm

Protected against false pulse on power-up and continuous overload or short circuit of outputs

Output Response

1.7 milliseconds ON; 1.1 milliseconds OFF

Note: 200-millisecond delay on power-up; outputs do not conduct during this time

Adjustments

Single-turn adjustment potentiometer sets the cutoff distance between minimum and maximum positions

Repeatability

130 µs (standard mode)

Indicators

Two LED indicators on sensor top:

Green solid: Power on

Amber: Light sensed

Amber flashing: Marginal sensing condition

Construction

ABS front housing and gain adjuster, PMMA lenses; Copolyamide rear housing

Connections

2 m (6.5 ft) unterminated 4-wire PVC-jacketed cable; 9 m (30 ft) unterminated 4-wire PVC-jacketed cable; 150 mm (6 in) PVC-jacketed cable with a 4-pin M8 male quick-disconnect connector; 150 mm (6 in) PVC-jacketed cable with a 4-pin M12 male quick-disconnect connector or Integral 4-pin M8 male quick-disconnect connector, depending on model

Models with a quick disconnect require a mating cordset

Environmental Rating

IP67

⁽¹⁾ IO-Link consumes a maximum of 15 mA in SIO mode

Operating Conditions

-20 °C to +60 °C (-4 °F to +140 °F)

95% relative humidity at 50 °C (non-condensing)

IO-Link Interface

Supports Smart Sensor Profile: Yes

Baud Rate: 38400 bps

Process Data Widths: 16 bits

IODD Files: Provides all programming options plus additional functionality; please see the IO-Link Data Reference Guide for more details

Certifications



Banner Engineering BV
 Park Lane, Culliganlaan 2F bus 3
 1831 Diegem, BELGIUM



Turck Banner LTD Blenheim House
 Blenheim Court
 Wickford, Essex SS11 8YT
 GREAT BRITAIN



Required Overcurrent Protection



WARNING: Electrical connections must be made by qualified personnel in accordance with local and national electrical codes and regulations.

Overcurrent protection is required to be provided by end product application per the supplied table.

Overcurrent protection may be provided with external fusing or via Current Limiting, Class 2 Power Supply.

Supply wiring leads < 24 AWG shall not be spliced.

For additional product support, go to www.bannerengineering.com.

Supply Wiring (AWG)	Required Overcurrent Protection (A)	Supply Wiring (AWG)	Required Overcurrent Protection (A)
20	5.0	26	1.0
22	3.0	28	0.8
24	1.0	30	0.5

FCC Part 15 Class A for Unintentional Radiators

This equipment has been tested and found to comply with the limits for a Class A digital device, pursuant to Part 15 of the FCC Rules. These limits are designed to provide reasonable protection against harmful interference when the equipment is operated in a commercial environment. This equipment generates, uses, and can radiate radio frequency energy and, if not installed and used in accordance with the instruction manual, may cause harmful interference to radio communications. Operation of this equipment in a residential area is likely to cause harmful interference in which case the user will be required to correct the interference at his own expense.

(Part 15.21) Any changes or modifications not expressly approved by the party responsible for compliance could void the user's authority to operate this equipment.

Industry Canada ICES-003(B)

This device complies with CAN ICES-3 (B)/NMB-3(B). Operation is subject to the following two conditions: 1) This device may not cause harmful interference; and 2) This device must accept any interference received, including interference that may cause undesired operation.

Cet appareil est conforme à la norme NMB-3(B). Le fonctionnement est soumis aux deux conditions suivantes : (1) ce dispositif ne peut pas occasionner d'interférences, et (2) il doit tolérer toute interférence, y compris celles susceptibles de provoquer un fonctionnement non souhaité du dispositif.

Performance Curves

The minimum sensing range for 6% reflectivity is 12 mm.

Emitter Beam Diameter graph

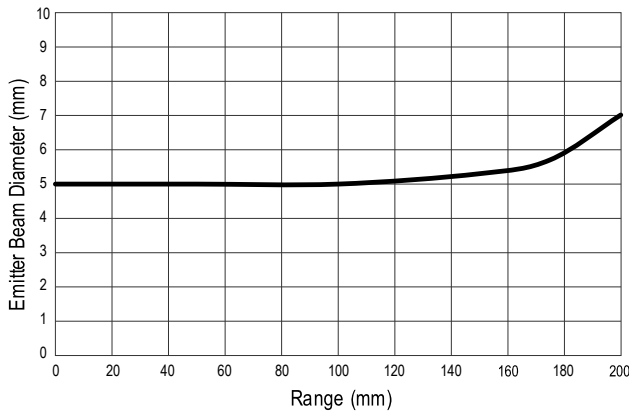

Minimum Separation Between Object and Background

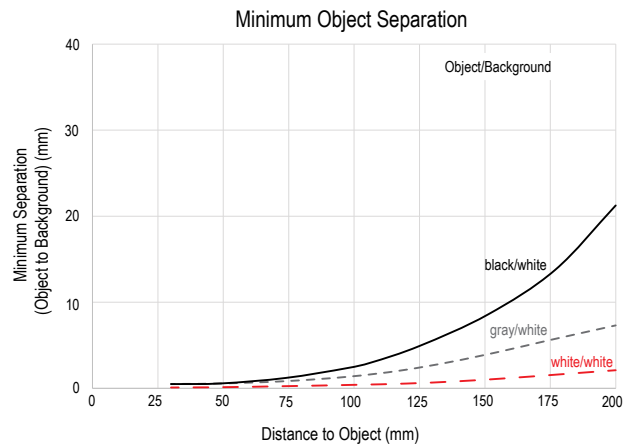

Excess Gain Curves

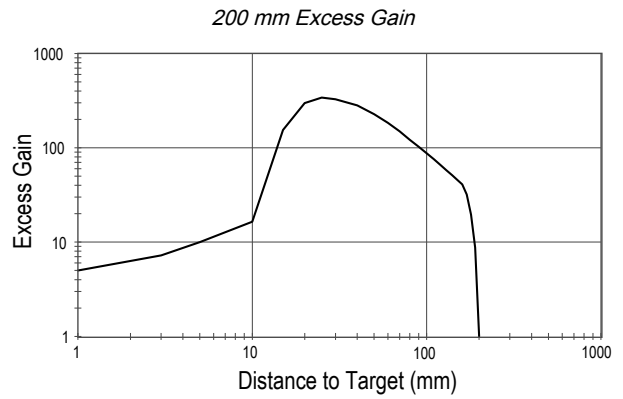
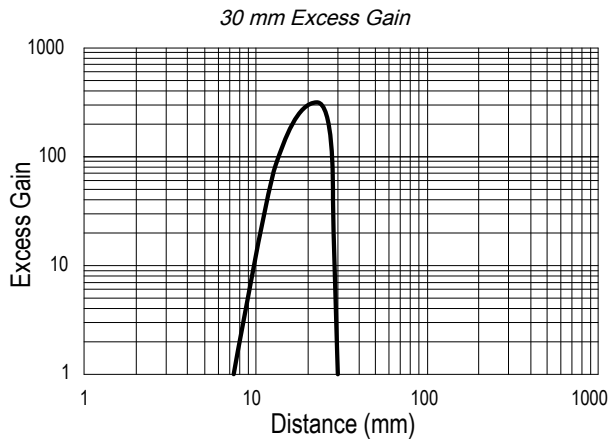

Dimensions

All measurements are listed in millimeters [inches], unless noted otherwise. The measurements provided are subject to change.

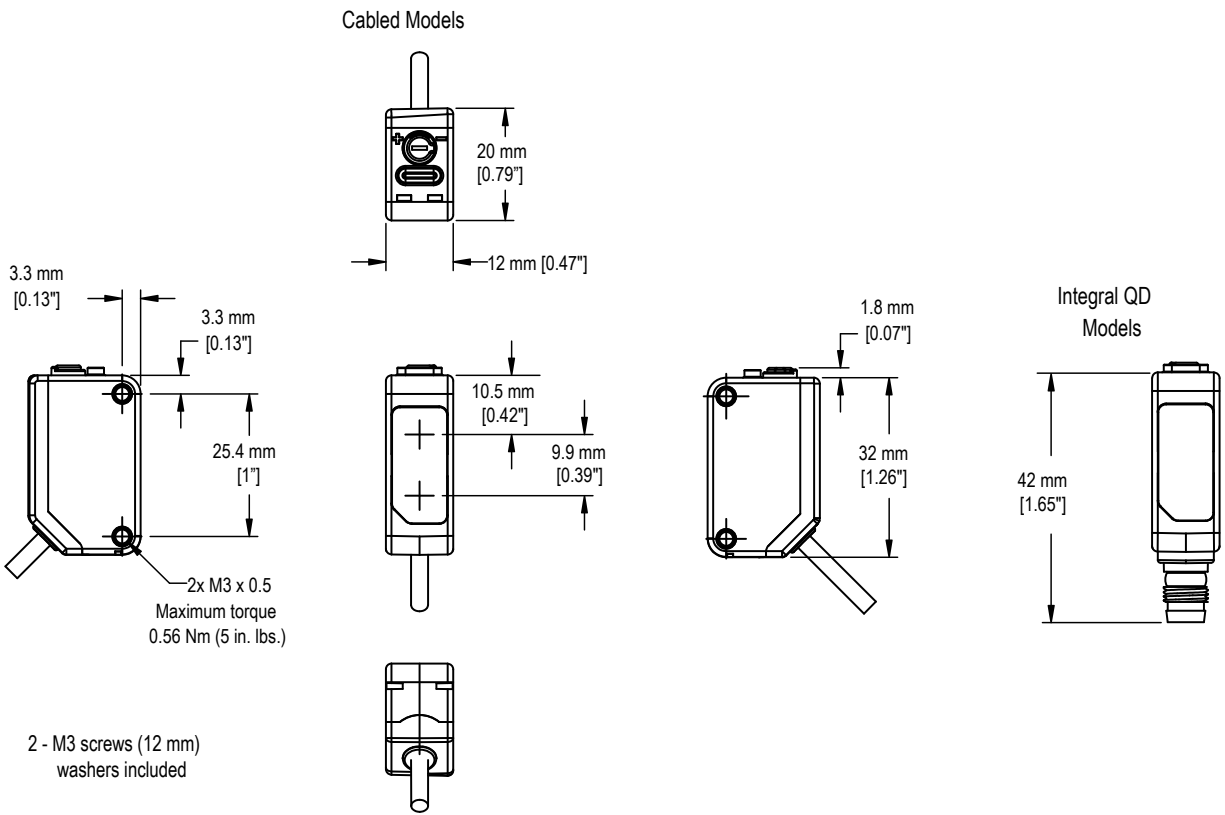

Chapter Contents

Quick-Disconnect (QD) Cordsets 10
 Mounting Brackets..... 11

Chapter 4 Accessories

Quick-Disconnect (QD) Cordsets

4-Pin Single-Ended M12 Female Cordsets				
Model	Length	Style	Dimensions	Pinout (Female)
MQDC-406	2 m (6.56 ft)	Straight		
MQDC-415	5 m (16.4 ft)			
MQDC-430	9 m (29.5 ft)			
MQDC-450	15 m (49.2 ft)	Right-Angle		
MQDC-406RA	2 m (6.56 ft)			
MQDC-415RA	5 m (16.4 ft)			
MQDC-430RA	9 m (29.5 ft)			
MQDC-450RA	15 m (49.2 ft)	Right-Angle		
MQDC-406RA	2 m (6.56 ft)			
MQDC-415RA	5 m (16.4 ft)			
MQDC-430RA	9 m (29.5 ft)			

1 = Brown
 2 = White
 3 = Blue
 4 = Black
 5 = Not used

4-Pin Single-Ended Snap-on M8 Female Cordsets				
Model	Length	Style	Dimensions	Pinout (Female)
PKG4-2	2.03 m (6.66 ft)	Straight		
PKW4Z-2	2 m (6.56 ft)	Right-Angle		

1 = Brown
 2 = White
 3 = Blue
 4 = Black

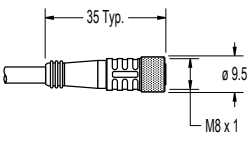
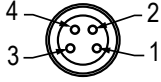
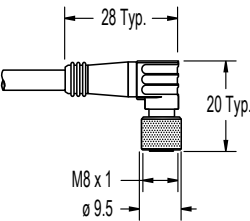
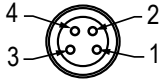
4-Pin Single-Ended M8 Female Cordsets				
Model	Length	Style	Dimensions	Pinout (Female)
PKG4M-2	2 m (6.56 ft)	Straight		
PKG4M-5	5 m (16.4 ft)			
PKG4M-9	9 m (29.52 ft)			
PKW4M-2	2 m (6.56 ft)	Right Angle		
PKW4M-5	5 m (16.4 ft)			
PKW4M-9	9 m (29.5 ft)			

1 = Brown
 2 = White
 3 = Blue
 4 = Black

Mounting Brackets

SMBQ20L

- Sensor vertical base mount
- ±5° tip, ±7° swivel
- Stainless steel

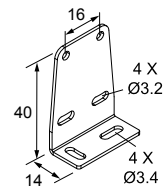

SMBQ20LV

- Sensor vertical back mount
- ±10° tip
- Stainless steel

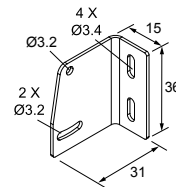

SMBQ20H

- Sensor horizontal flange mount
- ±10° swivel
- Stainless steel

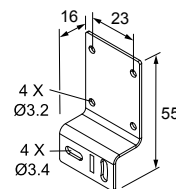

SMBQ20U

- Sensor vertical base mount with protection
- ±22.5° swivel
- Stainless steel

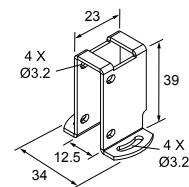

Chapter Contents

Clean Sensor with Compressed Air Then Isopropyl Alcohol	12
Repairs	12
Contact Us	12
Banner Engineering Corp Limited Warranty	12

Chapter 5 Product Support and Maintenance

Clean Sensor with Compressed Air Then Isopropyl Alcohol

Handle the sensor with care during installation and operation. Sensor windows soiled by fingerprints, dust, water, oil, etc. create stray light that may degrade the peak performance of the sensor.

Blow dust from the sensor using filtered, compressed air. If the sensor is still dirty, gently wipe the sensor with a dry optical cloth. If the dry optical cloth does not remove all residue, use 70% isopropyl alcohol on a clean optical cloth, then dry with a clean dry optical cloth and blow with filtered, compressed air. Do not use any other chemicals for cleaning.

Repairs

Contact Banner Engineering for troubleshooting of this device. **Do not attempt any repairs to this Banner device; it contains no field-replaceable parts or components.** If the device, device part, or device component is determined to be defective by a Banner Applications Engineer, they will advise you of Banner's RMA (Return Merchandise Authorization) procedure.

IMPORTANT: If instructed to return the device, pack it with care. Damage that occurs in return shipping is not covered by warranty.

Contact Us

Banner Engineering Corp. headquarters is located at: 9714 Tenth Avenue North | Plymouth, MN 55441, USA | Phone: + 1 888 373 6767

For worldwide locations and local representatives, visit www.bannerengineering.com.

Banner Engineering Corp Limited Warranty

Banner Engineering Corp. warrants its products to be free from defects in material and workmanship for one year following the date of shipment. Banner Engineering Corp. will repair or replace, free of charge, any product of its manufacture which, at the time it is returned to the factory, is found to have been defective during the warranty period. This warranty does not cover damage or liability for misuse, abuse, or the improper application or installation of the Banner product.

THIS LIMITED WARRANTY IS EXCLUSIVE AND IN LIEU OF ALL OTHER WARRANTIES WHETHER EXPRESS OR IMPLIED (INCLUDING, WITHOUT LIMITATION, ANY WARRANTY OF MERCHANTABILITY OR FITNESS FOR A PARTICULAR PURPOSE), AND WHETHER ARISING UNDER COURSE OF PERFORMANCE, COURSE OF DEALING OR TRADE USAGE.

This Warranty is exclusive and limited to repair or, at the discretion of Banner Engineering Corp., replacement. **IN NO EVENT SHALL BANNER ENGINEERING CORP. BE LIABLE TO BUYER OR ANY OTHER PERSON OR ENTITY FOR ANY EXTRA COSTS, EXPENSES, LOSSES, LOSS OF PROFITS, OR ANY INCIDENTAL, CONSEQUENTIAL OR SPECIAL DAMAGES RESULTING FROM ANY PRODUCT DEFECT OR FROM THE USE OR INABILITY TO USE THE PRODUCT, WHETHER ARISING IN CONTRACT OR WARRANTY, STATUTE, TORT, STRICT LIABILITY, NEGLIGENCE, OR OTHERWISE.**

Banner Engineering Corp. reserves the right to change, modify or improve the design of the product without assuming any obligations or liabilities relating to any product previously manufactured by Banner Engineering Corp. Any misuse, abuse, or improper application or installation of this product or use of the product for personal protection applications when the product is identified as not intended for such purposes will void the product warranty. Any modifications to this product without prior express approval by Banner Engineering Corp will void the product warranties. All specifications published in this document are subject to change; Banner reserves the right to modify product specifications or update documentation at any time. Specifications and product information in English supersede that which is provided in any other language. For the most recent version of any documentation, refer to: www.bannerengineering.com.

For patent information, see www.bannerengineering.com/patents.

