

EB2532YA12-30.000M TR

[Click part number to visit Part Number Details page](#)

REGULATORY COMPLIANCE (Data Sheet downloaded on Jan 8, 2020)



◀ Click badges to download compliance docs

Regulatory Compliance standards are subject to updates by governing bodies. Click the badges to download the latest compliance docs for this part number directly from Ecliptek.



ITEM DESCRIPTION

Automotive Grade Quartz Crystal Resonator 2.5mm x 3.2mm x 0.8mm 4 Pad Ceramic Surface Mount (SMD)
30.000MHz ± 30 ppm at 25°C, ± 50 ppm over -40°C to +125°C 12pF Parallel Resonant



ELECTRICAL SPECIFICATIONS

Nominal Frequency	30.000MHz
Frequency Tolerance/Stability	± 30 ppm at 25°C, ± 50 ppm over -40°C to +125°C
Aging at 25°C	± 3 ppm/Year Maximum
Load Capacitance	12pF Parallel Resonant
Shunt Capacitance (C0)	3pF Maximum
Equivalent Series Resistance	50 Ohms Maximum
Mode of Operation	AT-Cut Fundamental
Drive Level	200 μ Watts Maximum
Crystal Cut	AT-Cut
Spurious Response	-3dB Minimum (Measured from Fo to Fo +5000ppm)
Storage Temperature Range	-50°C to +150°C
Insulation Resistance	500 Megaohms Minimum (Measured at 100Vdc)

ENVIRONMENTAL & MECHANICAL SPECIFICATIONS

ESD Susceptibility	MIL-STD-883, Method 3015, Class 1, HBM: 1500V
Fine Leak Test	MIL-STD-883, Method 1014, Condition A
Flammability	UL94-V0
Gross Leak Test	MIL-STD-883, Method 1014, Condition C
Mechanical Shock	MIL-STD-883, Method 2002, Condition B
Moisture Resistance	MIL-STD-883, Method 1004
Moisture Sensitivity	J-STD-020, MSL 1
Resistance to Soldering Heat	MIL-STD-202, Method 210, Condition K
Resistance to Solvents	MIL-STD-202, Method 215
Solderability	MIL-STD-883, Method 2003
Temperature Cycling	MIL-STD-883, Method 1010, Condition B
Vibration	MIL-STD-883, Method 2007, Condition A

EB2532YA12-30.000M TR [Click part number to visit Part Number Details page](#)

MECHANICAL DIMENSIONS (all dimensions in millimeters)

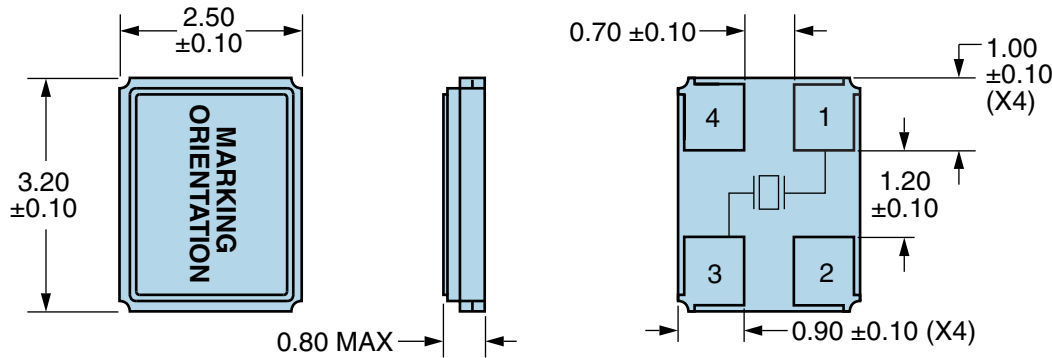

PIN	CONNECTION
1	Crystal
2	Cover/Ground
3	Crystal
4	No Connect

LINE	MARKING
1	
2	XXX XXX=Ecliptek Manufacturing Identifier

Note: Chamfer not shown.

Seam Sealed

Terminal Plating Thickness: Gold (0.3 to 1.0µm) over Nickel (1.27 to 8.89µm).

Suggested Solder Pad Layout

All Dimensions in Millimeters

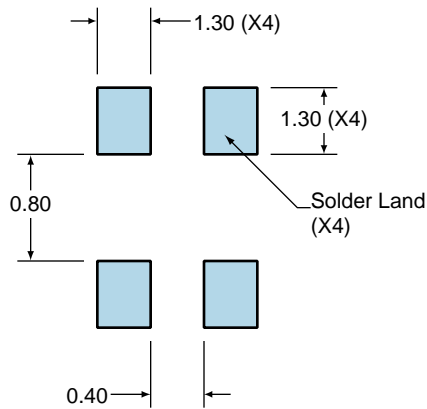

All Tolerances are ±0.1

EB2532YA12-30.000M TR

Tape & Reel Dimensions

Quantity Per Reel: 3,000 units

All Dimensions in Millimeters

Compliant to EIA-481



EB2532YA12-30.000M TR [Click part number to visit Part Number Details page](#)

Recommended Solder Reflow Methods



High Temperature Infrared/Convection

$T_s \text{ MAX}$ to T_L (Ramp-up Rate)	3°C/Second Maximum
Preheat	
- Temperature Minimum ($T_s \text{ MIN}$)	150°C
- Temperature Typical ($T_s \text{ TYP}$)	175°C
- Temperature Maximum ($T_s \text{ MAX}$)	200°C
- Time ($t_s \text{ MIN}$)	60 - 180 Seconds
Ramp-up Rate (T_L to T_P)	3°C/Second Maximum
Time Maintained Above:	
- Temperature (T_L)	217°C
- Time (t_L)	60 - 150 Seconds
Peak Temperature (T_P)	260°C Maximum for 10 Seconds Maximum
Target Peak Temperature ($T_P \text{ Target}$)	250°C +0/-5°C
Time within 5°C of actual peak (t_p)	20 - 40 Seconds
Ramp-down Rate	6°C/Second Maximum
Time 25°C to Peak Temperature (t)	8 Minutes Maximum
Moisture Sensitivity Level	Level 1
Additional Notes	Temperatures shown are applied to body of device.

EB2532YA12-30.000M TR [Click part number to visit Part Number Details page](#)

Recommended Solder Reflow Methods



Low Temperature Infrared/Convection 245°C

T_s MAX to T_L (Ramp-up Rate)	5°C/Second Maximum
Preheat	
- Temperature Minimum (T_s MIN)	N/A
- Temperature Typical (T_s TYP)	150°C
- Temperature Maximum (T_s MAX)	N/A
- Time (t_s MIN)	30 - 60 Seconds
Ramp-up Rate (T_L to T_P)	5°C/Second Maximum
Time Maintained Above:	
- Temperature (T_L)	150°C
- Time (t_L)	200 Seconds Maximum
Peak Temperature (T_P)	245°C Maximum
Target Peak Temperature (T_P Target)	245°C Maximum 2 Times / 230°C Maximum 1 Time
Time within 5°C of actual peak (t_p)	10 Seconds Maximum 2 Times / 80 Seconds Maximum 1 Time
Ramp-down Rate	5°C/Second Maximum
Time 25°C to Peak Temperature (t)	N/A
Moisture Sensitivity Level	Level 1
Additional Notes	Temperatures shown are applied to body of device.

Low Temperature Manual Soldering

185°C Maximum for 10 Seconds Maximum, 2 times Maximum. (Temperatures shown are applied to body of device.)

High Temperature Manual Soldering

260°C Maximum for 5 Seconds Maximum, 2 times Maximum. (Temperatures shown are applied to body of device.)