

MEMS Oscillator, Low Power, LVCMOS, 1.000 MHz to 110.000 MHz

IM801 Series

Features:

- MEMS Technology
- Direct pin to pin drop-in replacement for industry-standard packages
- LVCMOS Compatible Output
- Industry-standard package 2.0 x 1.6, 2.5 x 2.0, 3.2 x 2.5, 5.0 x 3.2, and 7.0 x 5.0 mm x mm
- Six supply voltages options, +1.8 V, +2.5 V, +2.8 V, +3.3 V and +2.25 V to +3.63 V continuous
- Pb-free, Halogen-free, Antimony-free
- RoHS and REACH compliant
- Fast delivery times

Typical Applications:

- Fibre Channel
- Server and Storage
- GPON, EPON
- 100M / 1G / 10G Ethernet

Electrical Specifications:

Frequency Range	1.000 MHz to 110.000MHz	
Frequency Stability	See Part Number Guide	Inclusive of Initial Tolerance, Operating Temperature Range, Load, Voltage, and Aging (First year at +25 °C)
Operating Temperature	See Part Number Guide	
Supply Voltage (Vdd) 10%	See Part Number Guide	
Current Consumption	3.8 mA typ./ 4.5 mA max 3.7 mA typ./ 4.2 mA max 3.5 mA typ./ 4.1 mA max	No load condition, F = 20 MHz, Vdd = +2.8 V to +3.3 V No load condition, F = 20 MHz, Vdd = +2.5 V No load condition, F = 20 MHz, Vdd = +1.8 V
OE Disable Current	4.2 mA max 4.0 mA max	Vdd = +2.5 V to +3.3 V, OE = GND, Output in high-Z state Vdd = +1.8 V, OE = GND, Output in high-Z state
Standby Current	2.1 µA typ./ 4.3 µA max 1.1 µA typ. / 2.5 µA max 0.2 µA typ. / 1.3 µA max	\overline{ST} = GND, Vdd = +2.8 V to +3.3V \overline{ST} = GND, Vdd = +2.5 V \overline{ST} = GND, Vdd = +1.8 V
Waveform Output	LVCMOS / HCMOS	
Symmetry	45%/55%	50% of waveform all Vdds
Rise / Fall Time	1.0 nSec typ./ 2.0 nSec max 1.3 nSec typ./ 2.5 nSec max	Vdd = +2.5 V, +2.8 V, + 3.0 V or +3.3 V from 20% to 80% of waveform Vdd = +1.8 V from 20% to 80% of waveform
Logic "1"	90% of Vdd min	
Logic "0"	10% of Vdd max	
Input High Voltage	70% of Vdd min	Pin 1, OE or \overline{ST}
Input Low Voltage	30% of Vdd max	Pin 1, OE or \overline{ST}
Input Pull-up Impedance	50kΩ min / 87kΩ typ. 150kΩ max 2.0MΩ min	Pin 1, OE logic high or logic low or \overline{ST} logic high Pin 1, \overline{ST} logic Low
Startup Time	5.0 mSec max	Measured from the time Vdd reaches its rated min value
Enable/Disable time	130 nSec max	F = 110 Mhz. For other frequencies, T_oe = 100 nSec = 3 cycles
Resume Time	5.0 mSec max	Measured from the time \overline{ST} pin crosses 50% threshold
RMS Period Jitter	1.8pSec typ./ 3.0pSec max 1.8pSec typ./ 3.0pSec max.	F = 75 MHz, Vdd = +2.5 V, +2.8 V, + 3.0 V or +3.3 V F = 75 MHz, Vdd = +1.8 V
Peak-to-peak Period Jitter	12.0 pSec typ./ 25.0 pSec max 14.0 pSec typ./ 30.0 pSec max	F = 75 MHz, Vdd = +2.5 V, +2.8 V, + 3.0 V or +3.3 V F = 75 MHz, Vdd = +1.8 V
RMS Phase Jitter (random)	0.5pSec typ./ 0.9 pSec max 1.3pSec typ./ 2.0pSec max	F = 75 MHz, Integration Bandwidth = 900 kHz to 7.5 MHz F = 75 MHz, Integration Bandwidth = 12 kHz to 20.0 MHz

Notes:

- All min and max limits are specified over temperature and rated operating voltage with 15pF output unless otherwise stated.
- Typical values are at +25°C and nominal supply voltage.

Absolute Maximum Limits

Storage Temperature	-65°C to +150°C
Supply Voltage (Vdd)	-0.5 VDC to 4.0 VDC
Electrostatic Discharge	2000 V max
Solder Temperature (follow standard Pb free soldering guidelines)	260°C max
Junction Temperature	150°C max

Ordering Information:

Part Number Guide						
Packages	Input Voltage	Operating Temperature	Output Drive Strength	Stability (ppm)	Select Function	Frequency
IM801A – 7.0 x 5.0	1 = +1.8 V	1 = 0°C to +70°C	- = Default	E = ±10	H = Tri-State	- Frequency
IM801B – 5.0 x 3.2	6 = +2.5 V	2 = -40°C to +85°C	(see tables 2 through 6)	F = ±20	S = Standby	
IM801C – 3.2 x 2.5	2 = +2.8 V	3 = -20°C to +70°C		A = ±25	O = N/C	
IM801D – 2.5 x 2.0	7 = +3.0 V			B = ±50		
IM801E – 2.0 x 1.6	3 = +3.3 V 8 = +2.25 V to +3.63 V					

Sample Part Number: IM801C-62-FS-20.0000MHz

This 20.0000 MHz oscillator in a 3.2 x 2.5 package with stability ±20 ppm from -40°C to +85°C using a supply voltage of +2.5 V. The Output Drive Strength (Rise and Fall Time) is the default value 1.0 nSec per Table 3 with 15 pF load. With Pin 1 function as Standby

Sample Part Number: IM801D-71RAO-66.0000MHz

This 66.0000 MHz oscillator in a 2.5 x 2.0 package with stability ±25 ppm from 0°C to +70°C using a supply voltage of +3.0 V. The Output Drive Strength (Rise and Fall Time) is the R drive strength is 4.54 nSec per Table 5 with 30 pF load. With Pin 1 function is not connected

Notes:

- Not all options are available at all frequencies and temperatures ranges.
- Please consult with sales department for any other parameters or options.
- Oscillator specification subject to change without notice.

Test Circuit

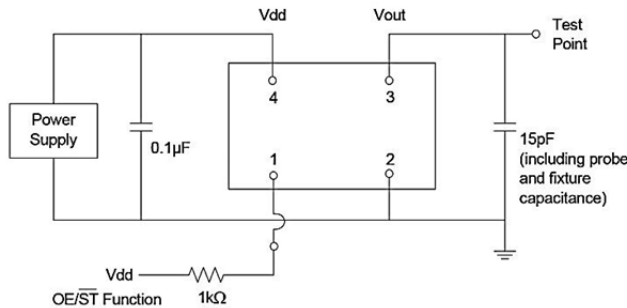

Waveform

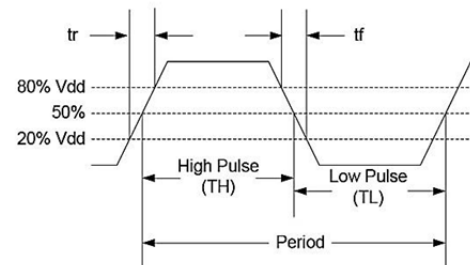

Performance Plots:

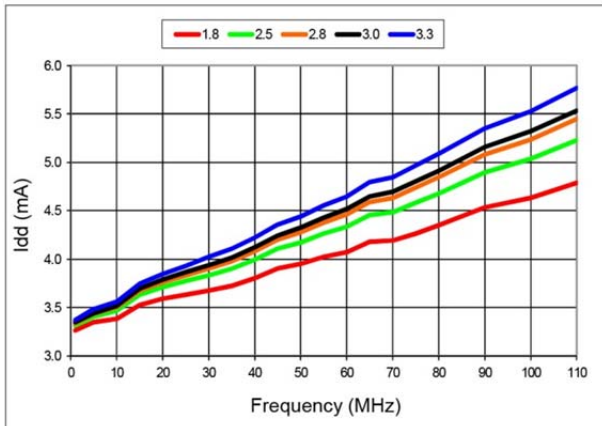

Figure 1: Idd vs Frequency

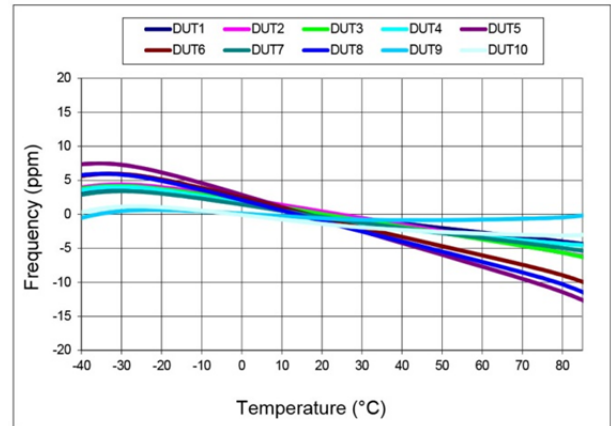

Figure 2: Frequency vs Temperature

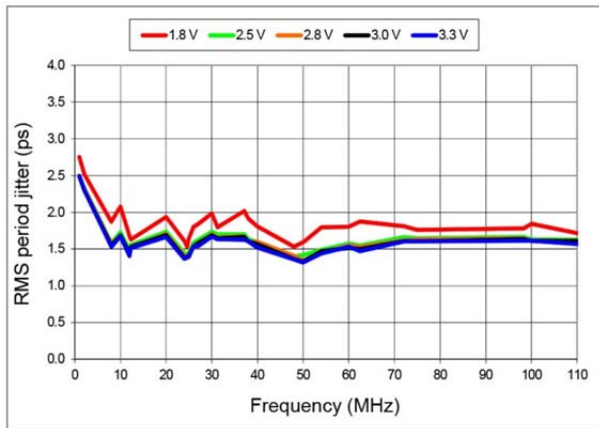

Figure 3: RMS Period Jitter vs Frequency

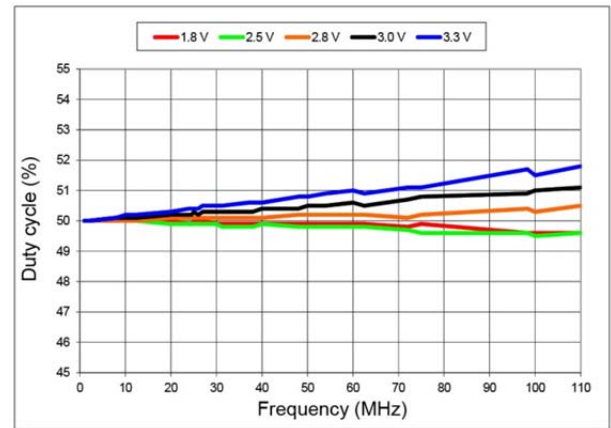

Figure 4: Duty Cycle vs Frequency

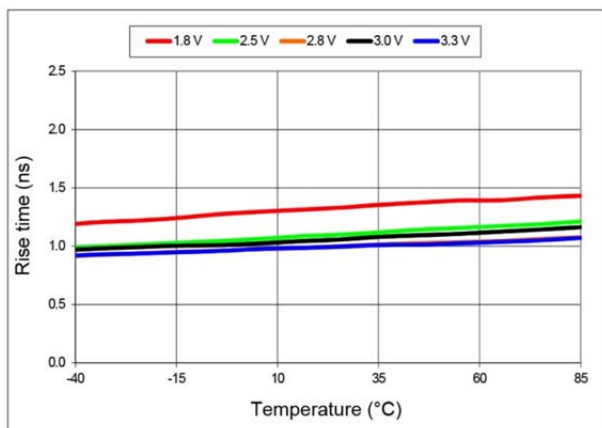

Figure 5: 20% to 80% Rise Time vs Temperature

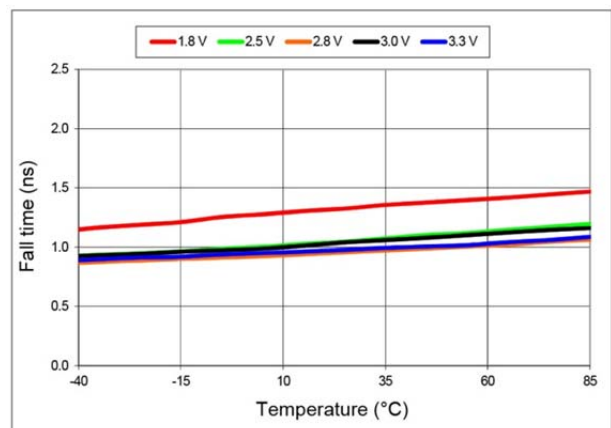

Figure 6: 20% to 80% Fall Time vs Temperature

Performance Plots (Cont.)

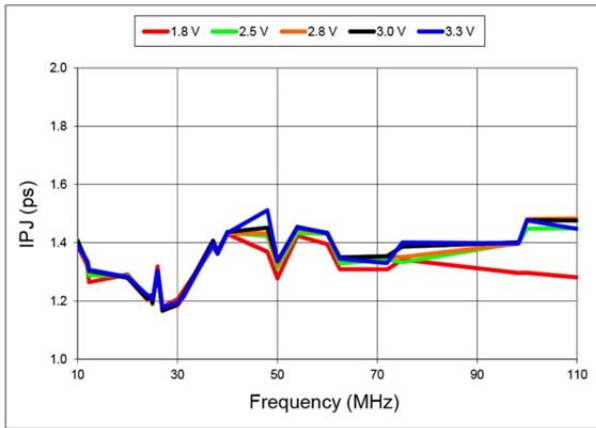

Figure 7: RMS Integrated Phase Jitter Random (12 kHz to 20 MHz) vs Frequency

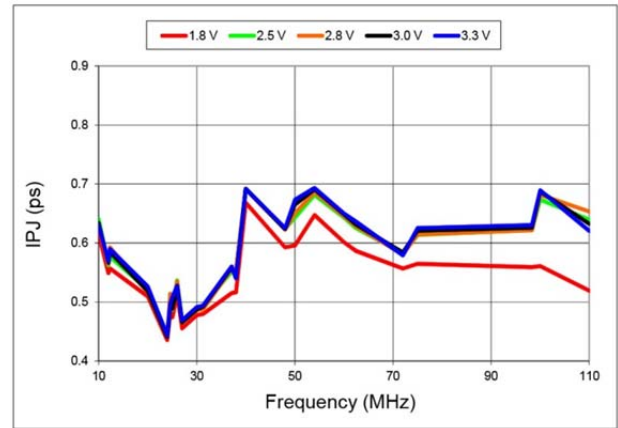

Figure 8: RMS Integrated Phase Jitter Random (900 kHz to 20 MHz) vs Frequency

- Notes:**
- All plots are measured with 15pF load at room temperature unless otherwise stated.
 - Phase noise plots are measured with Agilent E5052B signal source analyzer integration range is up to 5 MHz for carrier frequencies below 40 MHz

Environmental Specifications:

Environmental Compliance	
Parameter	Condition/Test Method
Mechanical Shock	MIL-STD-883F, Method 2002
Mechanical Vibration	MIL-STD-883F, Method 2007
Temperature Cycle	JESD22, Method A104
Solderability	MIL-STD-883F, Method 2003
Moisture Sensitivity Level	MSL1 at +260°C

Pb Free Solder Reflow Profile

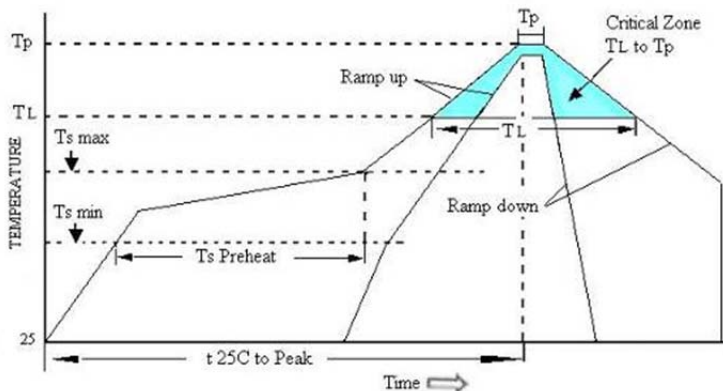

Units are backward compatible with +240°C reflow processes

Ts max to T _L (Ramp-up Rate)	3°C / second max
Preheat	
Temperature min (Ts min)	150°C
Temperature typ (Ts typ)	175°C
Temperature max (Ts max)	200°C
Time (Ts)	60 to 180 seconds
Ramp-up Rate (T _L to T _p)	3°C / second max
Time Maintained Above Temperature (T _L)	217°C
Time (T _L)	60 to 150 seconds
Peak Temperature (T _p)	260°C max for seconds
Time within 5°C to Peak Temperature (T _p)	20 to 40 seconds
Ramp-down Rate	6°C / second max
Tune 25°C to Peak Temperature	8 minute max
Moisture Sensitivity Level (MSL)	Level 1

Pin Functionally

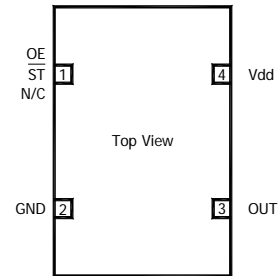
Pin Description				Pin Assignments
Pin	Symbol	Functionality		
1	OE	Tri-state	High or Open = specified frequency output Low = Output is high impedance, only output is disabled.	 <p>Top View</p> <p>Pin 1: OE, ST, N/C Pin 2: GND Pin 3: OUT Pin 4: Vdd</p>
	\overline{ST}	Standby	High or Open = specified frequency output. Low = Output is low. Device goes to sleep mode. Supply current reduces to standby current.	
	N/C	No Connect	Any voltage between 0.0 V to Vdd or Open = specified frequency output Pin 1 has no function	
2	GND	Power	Electrical ground	
3	Out	Output	Oscillator output	
4	Vdd	Power	Power supply voltage	
Notes:				
1. In OE or \overline{ST} mode, a pull-up resistor of 10.0 k Ω or less is recommended if Pin 1 is not externally driven. If Pin 1 needs to be left floating, use the NC option. 2. A capacitor of value 0.1 μ F or higher between Pin 4 (Vdd) and Pin 1 (GND) is required.				

Pin 1 Configuration Options (OE, or \overline{ST} , or NC)

Pin 1 of the IM801 can be factory-programmed to support three modes: Output Enable (OE), Standby (\overline{ST}) or No Connect (NC).

Output Enable (OE) Mode

In the OE mode, applying logic Low to the OE pin only disables the output driver and puts it in Hi-Z mode. The core of the device continues to operate normally. Power consumption is reduced due to the inactivity of the output. When the OE pin is pulled High, the output is typically enabled in <1 μ Sec.

Standby \overline{ST} Mode

In the ST mode, a device enters into the standby mode when Pin 1 pulled Low. All internal circuits of the device are turned off. The current is reduced to a standby current, typically in the range of a few μ A. When \overline{ST} is pulled High, the device goes through the "resume" process, which can take up to 5 mSec.

No Connect (NC) Mode

In the NC mode, the device always operates in its normal mode and outputs the specified frequency regardless of the logic level on Pin 1.

Table 1 below summarizes the key relevant parameters in the operation of the device in OE, ST, or NC mode.

Parameters	OE	ST	NC
Active current 20.0 MHz (max +1.80 VDC)	4.1 mA	4.1 mA	4.1 mA
OE disable current (max +1.80 VDC)	4.0 mA	N/A	N/A
Standby current (typical +1.80 VDC)	N/A	0.6 μ A	N/A
OE enable time at 20.0 MHz (max)	200 nSec	N/A	N/A
Resume time from standby (max, all frequency)	N/A	5 mSec	N/A
Output driver in OE disable/standby mode	High Z		N/A

Table 1 OE vs. \overline{ST} vs. NC

Timing Diagrams:

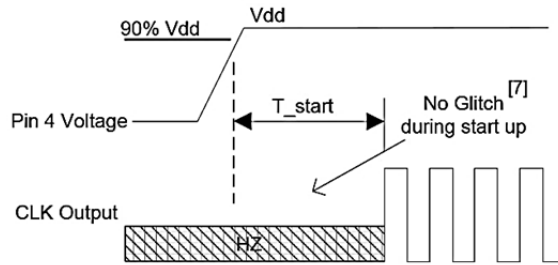

T_start: Time to start from power-off

Figure 9: Startup Timing (OE/ \overline{ST} Mode)

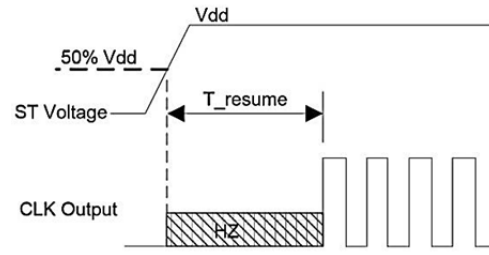

T_resume: Time to resume from ST

Figure 10: Standby Resume Timing (\overline{ST} Mode Only)

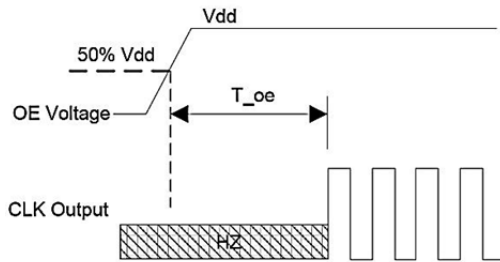

T_oe: Time to re-enable the clock output

Figure 11: OE Enable Timing (OE Mode Only)

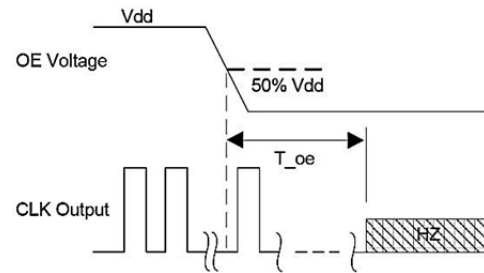

T_oe: Time to put the output in High Z mode

Figure 12: OE Disable Timing (OE Mode Only)

Selectable Drive Strength Options
Rise/Fall Time (20% to 80%) vs C_{LOAD} Tables

Rise/Fall Time Typ (nSec)					
Drive Strength (C _{LOAD})	5 pF	15 pF	30 pF	45 pF	60 pF
L	6.16	11.61	22.00	31.27	39.91
A	3.19	6.35	11.00	16.01	21.52
R	2.11	4.31	7.65	10.77	14.47
B	1.65	3.23	5.79	8.18	11.08
T	0.93	1.91	3.32	4.66	6.48
E	0.78	1.66	2.94	4.09	5.74
U	0.70	1.48	2.64	3.68	5.09
- = default	0.65	1.30	2.40	3.35	4.56

Table 2: V_{dd} = +1.8 V Rise / Fall time for Specific C_{LOAD}

Rise/Fall Time Typ (nSec)					
Drive Strength (C _{LOAD})	5 pF	15 pF	30 pF	45 pF	60 pF
L	4.13	8.25	12.82	21.45	27.79
A	2.11	4.27	7.64	11.20	14.49
R	1.45	2.81	5.16	7.65	9.88
B	1.09	2.20	3.88	5.86	7.57
T	0.62	1.28	2.27	3.51	4.45
- = default	0.54	1.00	2.01	3.10	4.01
U	0.43	0.96	1.81	2.79	3.65
F	0.34	0.88	1.64	2.54	3.32

Table 3: V_{dd} = +2.5 V Rise/Fall time for Specific C_{LOAD}

Rise/Fall Time Typ (nSec)					
Drive Strength (C _{LOAD})	5 pF	15 pF	30 pF	45 pF	60 pF
L	3.77	7.54	12.28	19.57	25.27
A	1.94	3.90	7.03	10.24	13.34
R	1.29	2.57	4.72	7.01	9.06
B	0.97	2.00	3.54	5.43	6.93
T	0.55	1.12	2.08	3.22	4.08
- = default	0.44	1.00	1.83	2.82	3.67
U	0.34	0.88	1.64	2.52	3.30
F	0.29	0.81	1.48	2.29	2.99

Table 4: V_{dd} = +2.8 V Rise/Fall time for Specific C_{LOAD}

Rise/Fall Time Typ (nSec)					
Drive Strength (C _{LOAD})	5 pF	15 pF	30 pF	45 pF	60 pF
L	3.60	7.21	11.97	18.74	24.30
A	1.84	3.71	6.72	9.86	12.68
R	1.22	2.46	4.54	6.76	8.62
B	0.89	1.92	3.39	5.20	6.64
- = default	0.51	1.00	1.97	3.07	3.90
E	0.38	0.92	1.72	2.71	3.51
U	0.30	0.83	1.55	2.40	3.13
F	0.27	0.76	1.39	2.16	2.85

Table 5: V_{dd} = +3.0 V Rise/Fall time for Specific C_{LOAD}

Rise/Fall Time Typ (nSec)					
Drive Strength (C _{LOAD})	5 pF	15 pF	30 pF	45 pF	60 pF
L	3.39	6.88	11.63	17.56	23.59
A	1.74	3.50	6.38	8.98	12.19
R	1.16	2.33	4.29	6.04	8.34
B	0.81	1.82	3.22	4.52	6.33
- = default)	0.46	1.00	1.86	2.60	3.84
E	0.33	0.87	1.64	2.30	3.35
U	0.28	0.79	1.46	2.05	2.93
F	0.29	0.81	1.31	1.83	2.61

Table 6: V_{dd} = +3.3 V Rise/Fall time for Specific C_{LOAD}

Mechanical Detail

Package Dimensions and Suggest Land Pattern

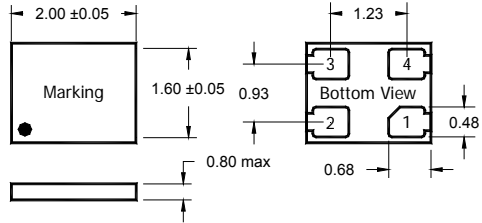
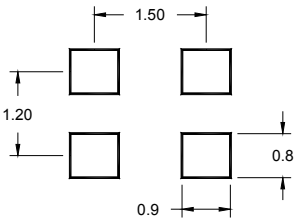
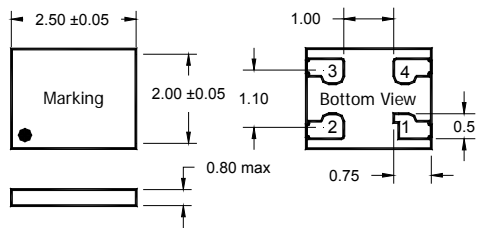
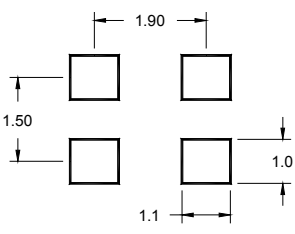
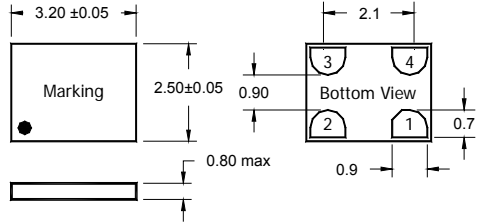
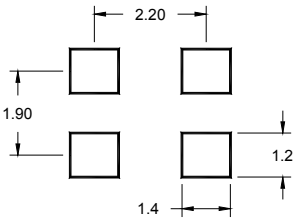
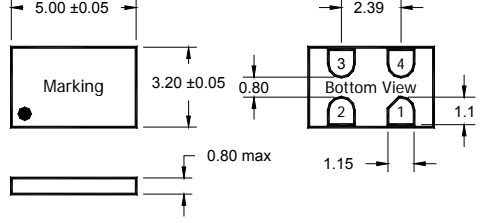
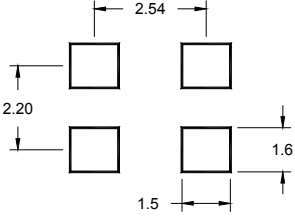
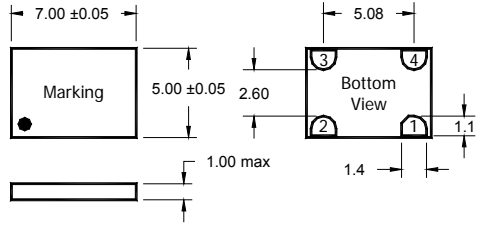
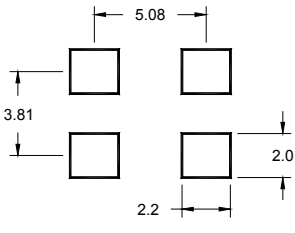
<p>Option E: 2.00 x 1.60 x 0.80 Package</p> 	<p>Suggested Land Pattern</p> 
<p>Option D: 2.50 x 2.00 x 0.80 Package</p> 	<p>Suggested Land Pattern</p> 
<p>Option C: 3.20 x 2.50 x 0.80 Package</p> 	<p>Suggested Land Pattern</p> 
<p>Option B: 5.00 x 3.20 X 0.80 Package</p> 	<p>Suggested Land Pattern</p> 
<p>Option A: 7.00 x 5.00 X 1.00 Package</p> 	<p>Suggested Land Pattern</p> 

Marking

Line 1 = XXXXX (Lot Code)
Dot to denote Pin 1 location

Package Information

Leadframe: C194
Plating: NiPdAu

Tape and Reel Dimensions

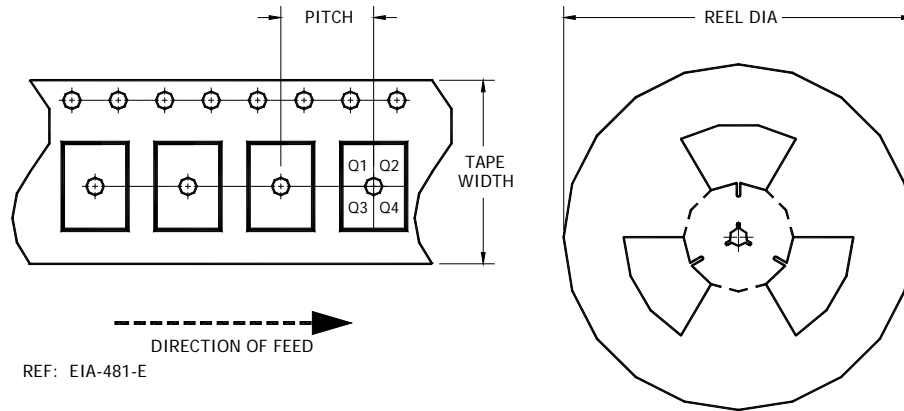

Part Number	Size	Pitch	Tape Width	Pin Orient.	Reel Dia.	Count
IM801A	7.0 x 5.0	8.0 ± 0.1	16.3 max	Q1	180	1000
					330	3000
IM801B	5.0 x 3.2	8.0 ± 0.1	12.3 max	Q1	180	1000
					330	3000
IM801C	3.2 x 2.5	4.0 ± 0.1	8.3 max	Q1	180	3000
IM801D	2.5 x 2.0	4.0 ± 0.1	8.3 max	Q1	180	3000
IM801E	2.0 x 1.6	4.0 ± 0.1	8.3 max	Q1	180	3000

Notes:

- All dimensions are in mm.
- Do not scale drawings.

PROPRIETARY AND CONFIDENTIAL

THIS DOCUMENT CONTAINS PROPRIETARY INFORMATION, AND SUCH INFORMATION MAY NOT BE DISCLOSED TO OTHERS FOR ANY PURPOSE NOR USED FOR MANUFACTURING PURPOSES WITHOUT WRITTEN PERMISSION FROM ILSI America.