

2336514-1 ✓ ACTIVE

Z-PACK | Z-PACK 2mm HM

TE Internal #: 2336514-1

Z-PACK 2mm HM, Hard Metric Backplane Connectors, PCB Mount Header, 1 Gb/s, 8 Columns, 5 Rows, Traditional Backplane, Board-to-Board, 40 Positions

[View on TE.com >](#)



Connectors > PCB Connectors > Backplane Connectors > Hard Metric Connectors

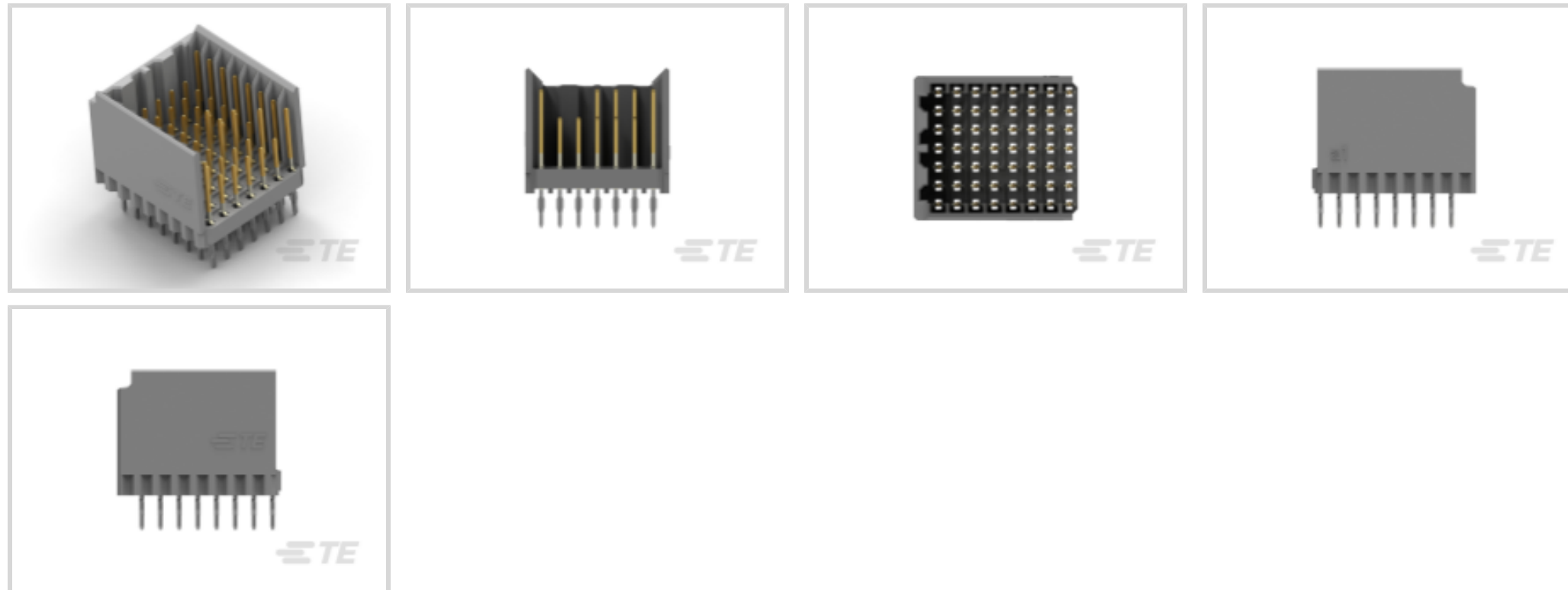

PCB Connector Assembly Type: **PCB Mount Header**

Data Rate: **1 Gb/s**

Number of Columns: **8**

Number of Rows: **5**

Backplane Architecture: **Traditional Backplane**

## Features

### Product Type Features

PCB Connector Assembly Type	PCB Mount Header
Connector System	Board-to-Board
Sealable	No
Connector & Contact Terminates To	Printed Circuit Board

### Configuration Features

Card Slot Centerline	2 mm
Mating & Unmating Configuration	Make First / Break Last, Sequencing
Rows Loaded	A, B, C, D, E (All Positions)
Number of Signal Positions	40
Number of Columns	8
Number of Rows	5
Backplane Architecture	Traditional Backplane
Number of Positions	40
PCB Mount Orientation	Vertical



### Signal Characteristics

Crosstalk Version	Standard
Data Rate	1 Gb/s

### Contact Features

Contact Type	Pin
Contact Base Material	Copper Alloy
CompactPCI Designation	None
Contact Mating Area Plating Material	Gold
Contact Current Rating (Max)	1.5 A

### Mechanical Attachment

Mating Alignment Type	Polarization
Connector Mounting Type	Board Mount

### Housing Features

Housing Material	Thermoplastic
Centerline (Pitch)	2 mm [.0787 in]
Housing Color	Natural

### Usage Conditions

Operating Temperature Range	-55 – 125 °C [-67 – 257 °F]
-----------------------------	-----------------------------

### Operation/Application

Shielded	No
Circuit Application	Signal

### Industry Standards

UL Flammability Rating	UL 94V-0
AdvancedTCA Specified Product	No

### Packaging Features

Packaging Method	Tube
------------------	------

### Product Compliance

[For compliance documentation, visit the product page on TE.com>](#)

EU RoHS Directive 2011/65/EU	Compliant
EU ELV Directive 2000/53/EC	Compliant
China RoHS 2 Directive MIIT Order No 32, 2016	No Restricted Materials Above Threshold



EU REACH Regulation (EC) No. 1907/2006

Current ECHA Candidate List: JUN 2020 (209)

Candidate List Declared Against: JAN 2020 (205)

Does not contain REACH SVHC

Halogen Content

Not Low Halogen - contains Br or Cl > 900 ppm.

Solder Process Capability

Not reviewed for solder process capability

Product Compliance Disclaimer

This information is provided based on reasonable inquiry of our suppliers and represents our current actual knowledge based on the information they provided. This information is subject to change. The part numbers that TE has identified as EU RoHS compliant have a maximum concentration of 0.1% by weight in homogenous materials for lead, hexavalent chromium, mercury, PBB, PBDE, DBP, BBP, DEHP, DIBP, and 0.01% for cadmium, or qualify for an exemption to these limits as defined in the Annexes of Directive 2011/65/EU (RoHS2). Finished electrical and electronic equipment products will be CE marked as required by Directive 2011/65/EU. Components may not be CE marked. Additionally, the part numbers that TE has identified as EU ELV compliant have a maximum concentration of 0.1% by weight in homogenous materials for lead, hexavalent chromium, and mercury, and 0.01% for cadmium, or qualify for an exemption to these limits as defined in the Annexes of Directive 2000/53/EC (ELV). Regarding the REACH Regulation, the information TE provides on SVHC in articles for this part number is based on the latest European Chemicals Agency (ECHA) 'Guidance on requirements for substances in articles' posted at this URL: <https://echa.europa.eu/guidance-documents/guidance-on-reach>

### Compatible Parts



### Also in the Series | Z-PACK 2mm HM

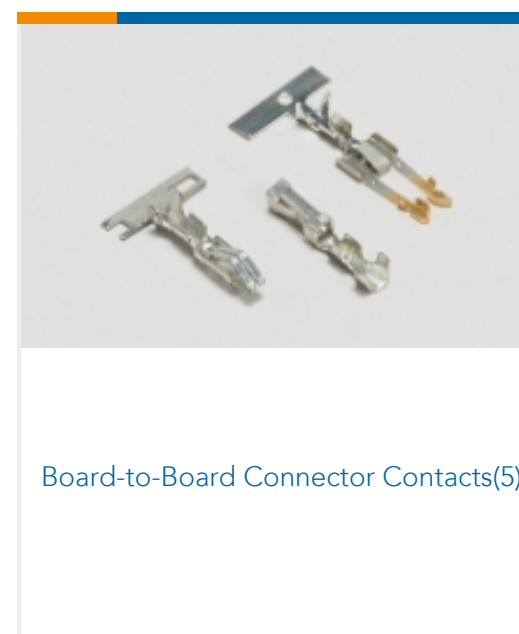
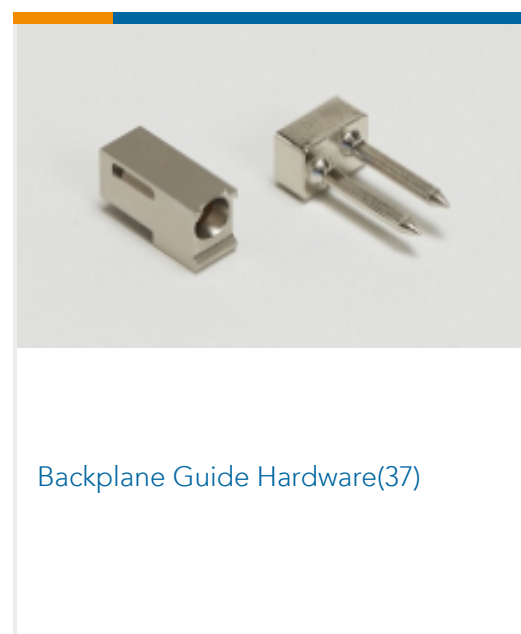
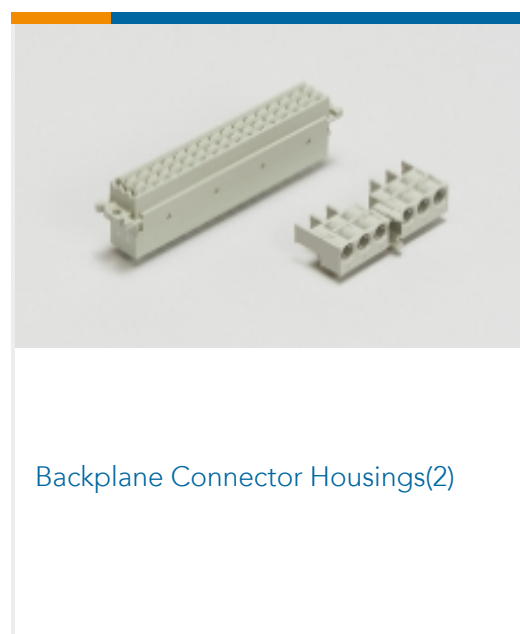

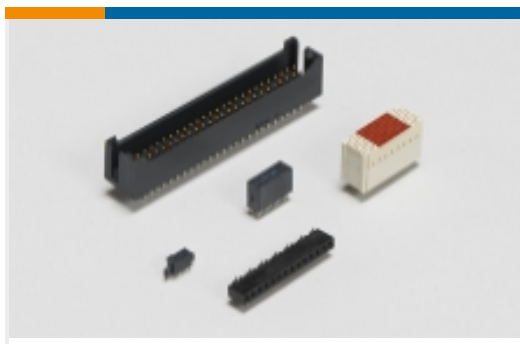

Board-to-Board Headers & Receptacles(5)

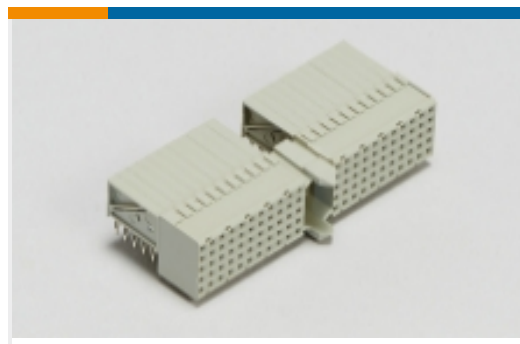

Hard Metric Backplane Connectors (254)

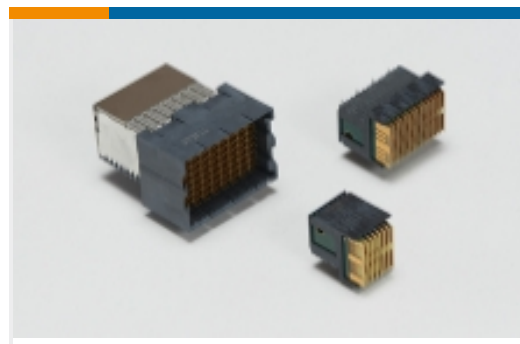

High Speed Backplane Connectors(15)

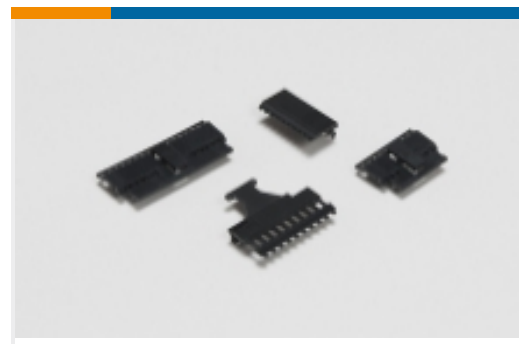

PCB Connector Covers(4)



PCB Connector Shrouds(42)



PCB Ferrules & Shields(19)



PCB Latches, Locks & Retainers(1)



Rectangular Power Connectors(87)

## Customers Also Bought



TE Model / Part #2212305-1  
FORGE, ASSY PIN, 4#0-0#4-0#8-0#12-2#22



TE Model / Part #2212307-1  
FORGE, ASSY SCKT, 4#0-0#4-0#8-0#12-2#22



TE Model / Part #2336682-1  
2MM HM FEMALE ASSY, COL8



TE Model / Part #2337822-2  
DISCR.ETH.MAG. 1GB SINGLE SMT



TE Model / Part #4-2176364-9  
RQ 0402 14K7 0.1% 10PPM 5K RL



TE Model / Part #1926171-1  
CONN,PIN,75Amp MIDDLE DWR



TE Model / Part #7-1879462-5  
RL73K 2B R68 5% 1K RL

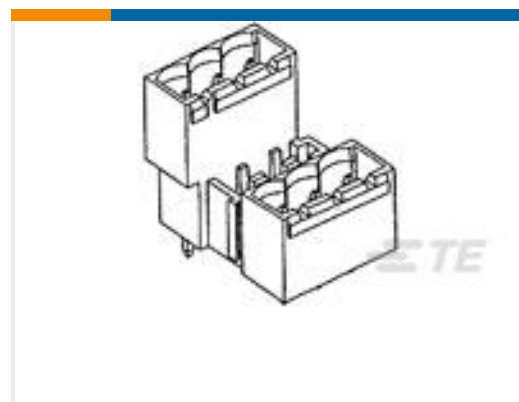

TE Model / Part #1-284065-6  
TERMI-BLOK HDR 180, 5,08MM P.M



TE Model / Part #2-1879336-1  
CPF 0603 374R 1% 50PPM 1K RL



TE Model / Part #  
YDTS32F23RV0010000  
DTS CAP ASSY, NICKEL, SIZE 23 PLUG

## Documents



### Product Drawings

#### 2MM HM MALE CONNECTOR, COL 8, M2

English

---

### CAD Files

#### 3D PDF

3D

#### Customer View Model

[ENG\\_CVM\\_CVM\\_2336514-1\\_A.2d\\_dxf.zip](#)

English

#### Customer View Model

[ENG\\_CVM\\_CVM\\_2336514-1\\_A.3d\\_igs.zip](#)

English

#### Customer View Model

[ENG\\_CVM\\_CVM\\_2336514-1\\_A.3d\\_stp.zip](#)

English

By downloading the CAD file I accept and agree to the [Terms and Conditions](#) of use.

---

### Product Specifications

#### Application Specification

English