

# Single relay - REL-IR4/100AC/4X21 - 2907055

Please be informed that the data shown in this PDF Document is generated from our Online Catalog. Please find the complete data in the user's documentation. Our General Terms of Use for Downloads are valid (<http://phoenixcontact.com/download>)



Plug-in industrial relay with power contacts, 4 changeover contacts, test key, mechanical switch position indicator, polarity: bipolar, input voltage: 100 V AC



## Key Commercial Data

Packing unit	10 pc
GTIN	
GTIN	4055626175737
Weight per Piece (excluding packing)	32.720 g
Custom tariff number	85364900
Country of origin	Poland

## Technical data

### Dimensions

Width	21.2 mm
Height	27.5 mm
Depth	35.6 mm

### Ambient conditions

Ambient temperature (operation)	-40 °C ... 55 °C
Ambient temperature (storage/transport)	-40 °C ... 85 °C
Degree of protection	RT I

### Coil side

Nominal input voltage $U_N$	100 V AC
Input voltage range in reference to $U_N$	see diagram
Mains frequency	50/60 Hz
Typical input current at $U_N$	14.8 mA
Typical response time	5 ms ... 15 ms (depending on phase relation)

# Single relay - REL-IR4/100AC/4X21 - 2907055

## Technical data

### Coil side

Typical release time range	5 ms ... 20 ms (depending on phase relation)
Power dissipation for nominal condition	1.48 W

### Contact side

Contact type	4 PDTs
Type of switch contact	Single contact
Contact material	AgNi
Maximum switching voltage	250 V AC/DC
Minimum switching voltage	5 V (At 24 mA)
Min. switching current	5 mA (at 24 V)
Maximum inrush current	16 A (20 ms, N/O contact)
	12 A (4 s, N/O contacts)
Limiting continuous current	6 A
Interrupting rating (ohmic load) max.	144 W (at 24 V DC)
	124 W (at 48 V DC)
	108 W (at 60 V DC)
	52 W (at 110 V DC)
	48 W (at 220 V DC)
	1500 VA (for 250 V AC)
Switching capacity min.	0.12 W
Switching capacity	2 A (at 24 V, DC13)
	1 A (at 230 V, AC15)

### General

Test voltage relay winding/relay contact	2.5 kV <sub>rms</sub> (50 Hz, 1 min.)
Test voltage PDT/PDT	2.5 kV <sub>rms</sub> (50 Hz, 1 min.)
Operating mode	100% operating factor
Mechanical service life	1x 10 <sup>7</sup> cycles, approximately
Mounting position	any

### Connection data

Connection method	Plug connection
-------------------	-----------------

### Standards and Regulations

Standards/regulations	IEC 60664
	IEC 61810
Rated insulation voltage	250 V AC
Rated surge voltage	2.5 kV
Insulation	Basic insulation
Pollution degree	2
Overvoltage category	II

### Environmental Product Compliance

# Single relay - REL-IR4/100AC/4X21 - 2907055

## Technical data

### Environmental Product Compliance

China RoHS	Environmentally Friendly Use Period = 50
	For details about hazardous substances go to tab "Downloads", Category "Manufacturer's declaration"

## Drawings

Diagram

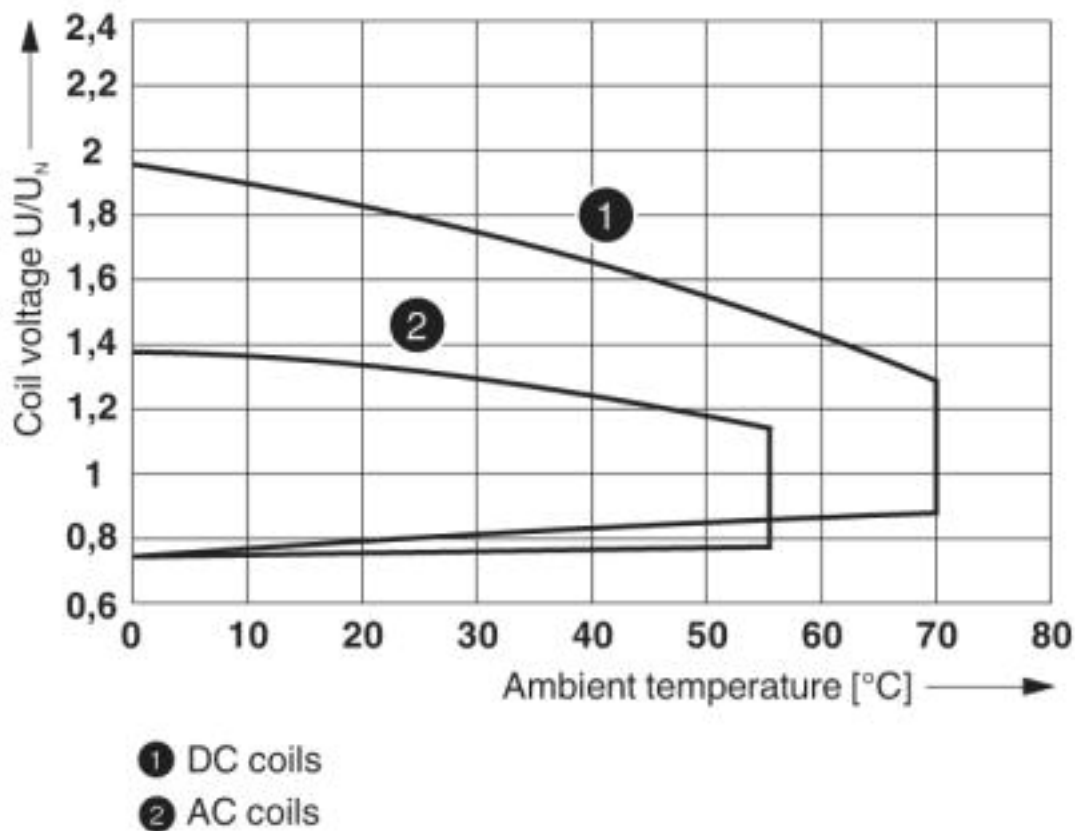

Operating voltage range

# Single relay - REL-IR4/100AC/4X21 - 2907055

Diagram

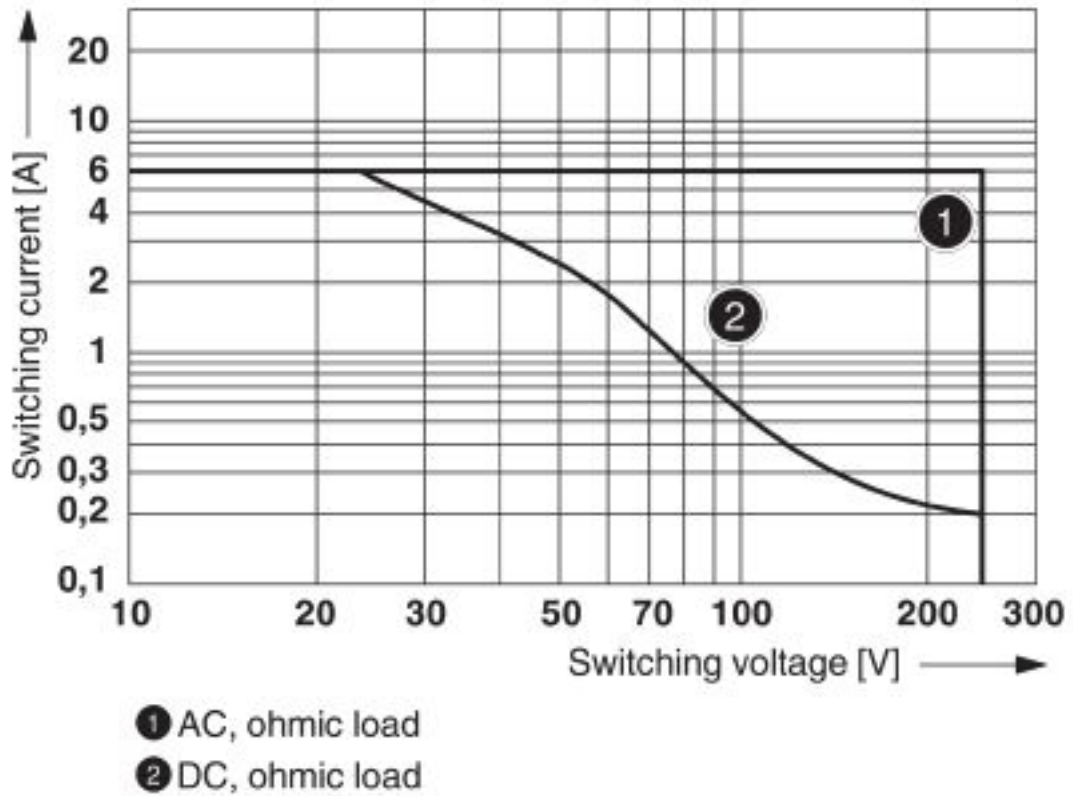

Interrupting rating

# Single relay - REL-IR4/100AC/4X21 - 2907055

Diagram

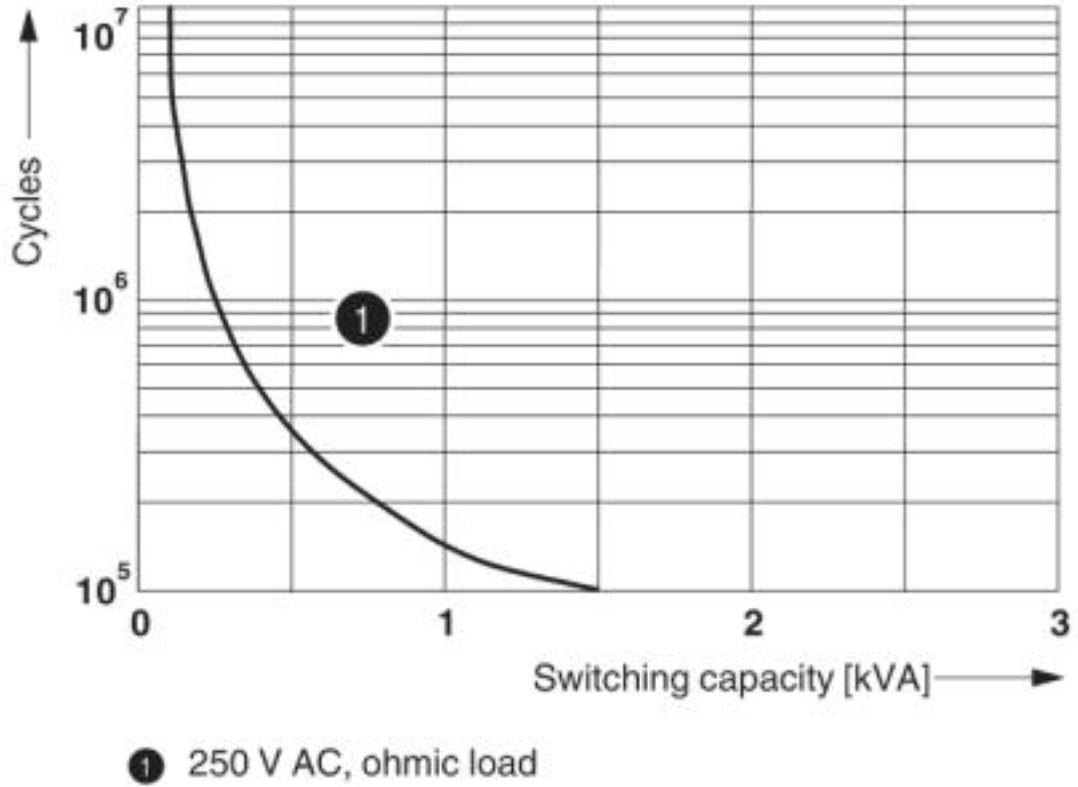

Electrical service life

# Single relay - REL-IR4/100AC/4X21 - 2907055

Diagram

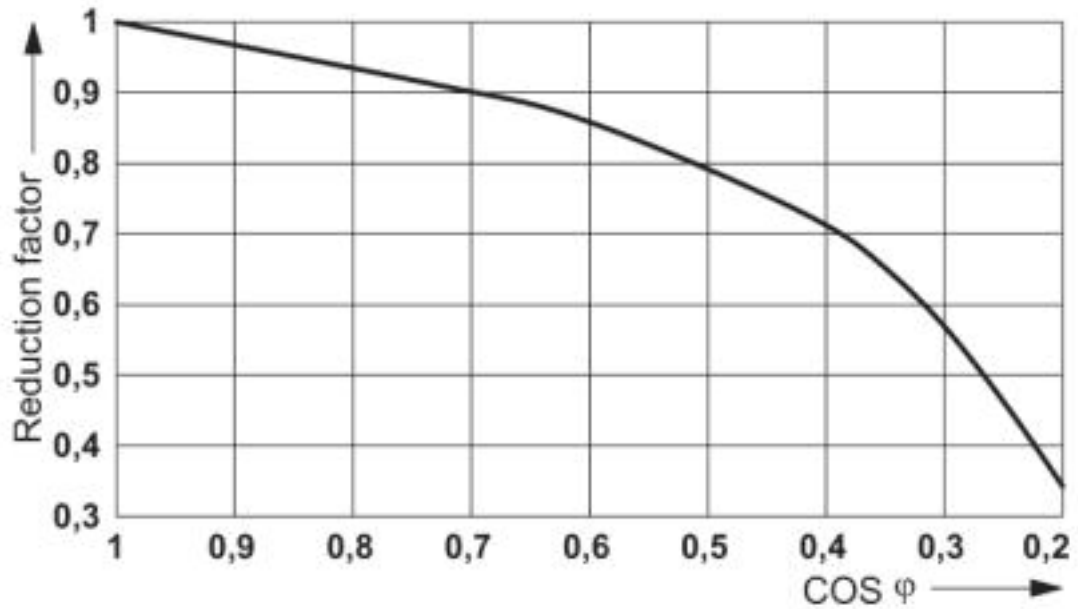

Service life reduction factor

Circuit diagram

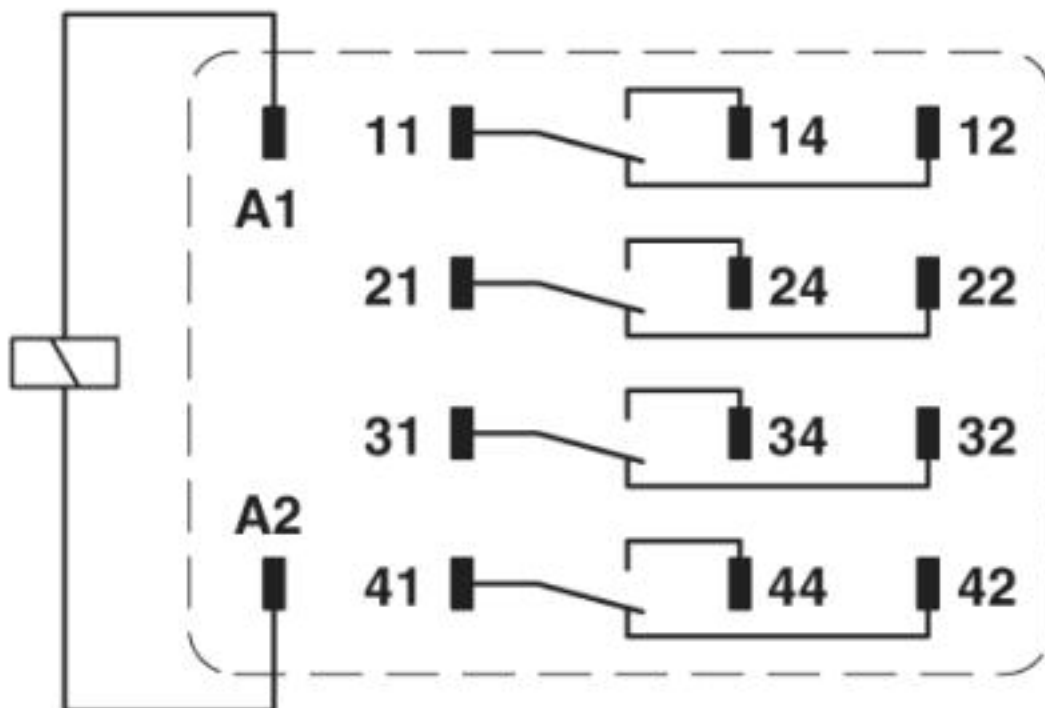

# Single relay - REL-IR4/100AC/4X21 - 2907055

## Classifications

### eCl@ss

eCl@ss 4.0	27371100
eCl@ss 4.1	27371100
eCl@ss 5.0	27371600
eCl@ss 5.1	27371600
eCl@ss 6.0	27371600
eCl@ss 7.0	27371601
eCl@ss 8.0	27371601
eCl@ss 9.0	27371601

### ETIM

ETIM 2.0	EC001437
ETIM 3.0	EC001437
ETIM 4.0	EC001437
ETIM 5.0	EC001437
ETIM 6.0	EC001437
ETIM 7.0	EC001437

### UNSPSC

UNSPSC 6.01	30211916
UNSPSC 7.0901	39121515
UNSPSC 11	39121515
UNSPSC 12.01	39121515
UNSPSC 13.2	39122334
UNSPSC 18.0	39122334
UNSPSC 19.0	39122334
UNSPSC 20.0	39122334
UNSPSC 21.0	39122334

## Approvals

### Approvals

---

#### Approvals

CSA / UL Recognized / cUL Recognized / EAC / EAC / cULus Recognized

---

#### Ex Approvals

---

### Approval details

# Single relay - REL-IR4/100AC/4X21 - 2907055

## Approvals

CSA		<a href="http://www.csagroup.org/services-industries/product-listing/">http://www.csagroup.org/services-industries/product-listing/</a>	2554095
UL Recognized		<a href="http://database.ul.com/cgi-bin/XYV/template/LISEXT/1FRAME/index.htm">http://database.ul.com/cgi-bin/XYV/template/LISEXT/1FRAME/index.htm</a>	FILE E 172140
cUL Recognized		<a href="http://database.ul.com/cgi-bin/XYV/template/LISEXT/1FRAME/index.htm">http://database.ul.com/cgi-bin/XYV/template/LISEXT/1FRAME/index.htm</a>	FILE E 172140
EAC			TR_TS_D_00573_c
EAC			TR_TS_S_00010_c
cULus Recognized			

## Accessories

### Additional products

Relay base - RIF-2-BPT/4X21 - 2900934



RIF-2... relay base, for industrial relay with 2 or 4 PDTs, push-in connection, plug-in option for input/suppressor modules, for mounting on NS 35/7,5

Relay base - RIF-2-BSC/4X21 - 2900932



RIF-2... relay base, for industrial relay with 2 or 4 changeover contacts, screw connection, plug-in option for input/interference suppression modules, for mounting on NS 35/7,5

