

Features

Regulated Converter

- Universal input 90-264VAC
- Efficiency 91%
- Short circuit and over voltage protected
- Active PFC function, PF>0.95
- Power indicator LED
- UL, CE marked (CB report)
- Conformal coated product
- RECOM connector set available



RAC150-G

150 Watt
4" x 2"



Open Frame or Enclosed Case



UL62368-1 certified
CAN/CSA C22.2 No. 62368-1-14 certified
UL60950 certified
CAN/CSA C22.2 N.60950-1-07 certified
IEC/EN60950-1 certified
EN55032/55024
FCC Part 15
CB Report

Description

The RAC150 series are cost-efficient 150 Watt AC/DC power supplies in a standard 2"x4" footprint with a universal input range of 90-264VAC for worldwide usage. They are built to deliver up to 125 Watt with natural air convection for use in tight, space-critical housings with low available airflow. UL and CE marks with CB-reports include the new 62368 safety standard as well as the usual 60950 safety standard. The RAC150 series offers tightly regulated 12V, 24V and 48VDC outputs with 3kVAC isolation and Class B EMC certifications and come with a three year warranty.

Selection Guide

Part Number	Input Voltage Range [VAC]	Output Voltage [VDC]	max. Output Current ⁽¹⁾ [mA]	Efficiency typ ⁽²⁾ [%]	Max. Capacitive Load ⁽³⁾ [µF]
RAC150-12SG ⁽⁴⁾	90-264	12	12500	91	2000
RAC150-24SG ⁽⁴⁾	90-264	24	6250	91	1000
RAC150-48SG ⁽⁴⁾	90-264	48	3125	91	500

Notes:

- Note1: With forced air cooling, refer to derating graph
 Note2: Typ. efficiency is tested @ 230VAC and full load
 Note3: Max. cap load is tested @ 90-264VAC and full resistive load

Model Numbering



Notes:

- Note4: add suffix "OF" for open frame version
 add suffix "ENC" for enclosed version

Ordering Examples:

RAC150-24SG/OF 24Vout Single open frame version
 RAC150-12SG/ENC 12Vout Single enclosed version

Specifications (measured @ Ta= 25°C, nom. Vin and full load unless otherwise stated)

BASIC CHARACTERISTICS					
Parameter	Condition		Min.	Typ.	Max.
Output Power	with forced cooling	90-264VAC			150W
	natural convection	230VAC			125W
		115VAC			120W
	90-115VAC		refer to "Derating Graph"		
Internal Input Filter			Pi type		
Input Voltage Range			90VAC	230VAC	264VAC
Input Current					2A
Inrush Current	cold start at 25°C	115VAC			40A
		230VAC			60A

continued on next page

Specifications (measured @ Ta= 25°C, nom. Vin, full load and after warm-up unless otherwise stated)

BASIC CHARACTERISTICS

Parameter	Condition		Min.	Typ.	Max.
Input Frequency Range			47Hz		63Hz
Minimum Load			0%		
Power Factor	115VAC 230VAC		0.98 0.95		
Rise Time	115VAC/230VAC				50ms
Hold-up Time	115VAC 230VAC	100% load 50% load	6ms	20ms	
Internal Operating Frequency				132kHz	
Output Ripple and Noise	+70°C	12Vout 24Vout 48Vout			150mVp-p 240mVp-p 360mVp-p
	-30°C	12Vout 24Vout 48Vout			300mVp-p 480mVp-p 720mVp-p

Efficiency vs. Load

RAC150-12SG

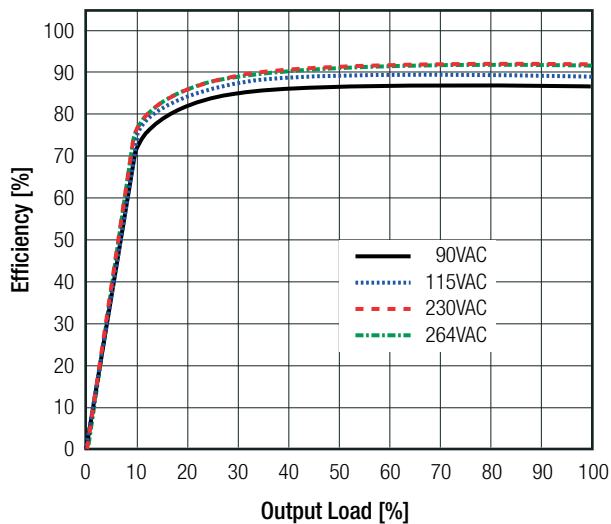

RAC150-24SG

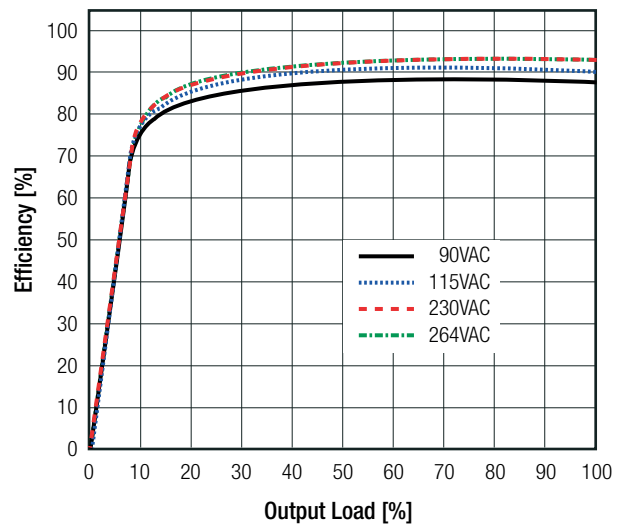

Efficiency vs. Input Voltage

(@ full load)

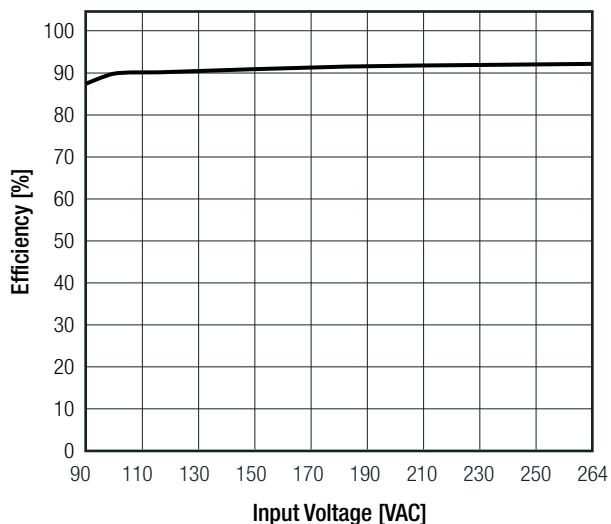

Recommended Line Derating <115VAC

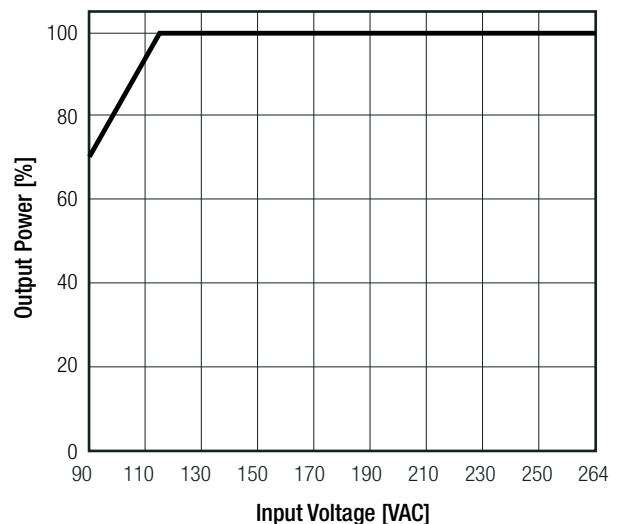

Specifications (measured @ Ta= 25°C, nom. Vin and full load unless otherwise stated)

REGULATIONS			
Parameter	Condition		Value
Output Accuracy	-30°C to +70°C		±2.0% max.
Line Regulation	-30°C to +70°C		±0.1% typ.
Load Regulation	-30°C to +70°C	0%-100% load	0.2 % typ.
Transient Response	-30°C to +70°C	25% load step change recovery time	±5.0% Vout max. 200µs max.

Normalized Output Deviation vs. Load

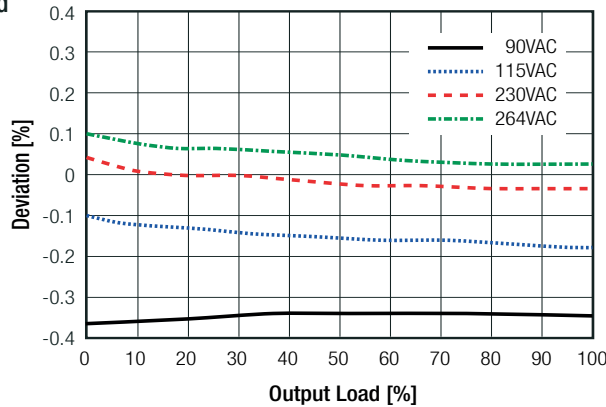

PROTECTIONS			
Parameter	Type		Value
Input fuse ⁽⁵⁾	internal		T3.15A
Short Circuit Protection (SCP)	below 100mΩ		continuous, Hiccup Mode, auto recovery
Over Voltage Protection (OVP)	105%-150% of Vout nominal		Latch OFF
Over Voltage Category			OVCII
Class of Equipment			Class I
Isolation Voltage ⁽⁶⁾	tested for 1 minute	I/P to O/P	3kVAC
		I/P to FG	1.5kVAC
		O/P to FG	0.5kVDC
Isolation Resistance	I/P to O/P; I/P to FG; O/P to FG		10MΩ min.
Isolation Capacitance			3300pF max.
Insulation Grade			reinforced
Leakage Current	240VAC, 63Hz		0.25mA max.
Notes:			
Note5: Refer to local safety regulations if input over-current protection is also required			
Note6: For repeat Hi-Pot testing, reduce the time and/or the test voltage			

ENVIRONMENTAL			
Parameter	Condition		Value
Operating Temperature Range	refer to derating graph		-30°C to +70°C
Temperature Coefficient			0.02%/K
Operating Altitude ⁽⁷⁾			5000m
Operating Humidity	non-condensing		20% - 90% RH max.
Pollution Degree			PD2
Conformal Coating			conformal coated product
Shock			20G, 11ms, 3 times for X,Y,Z axis
Vibration			10-500Hz, 3G, 10min. for each, 6cycles for each X,Y,Z
MTBF	according to MIL-HDBK-217F, G.B.	natural convection (125W)	100 x 10 ³ hours
	+25°C	forced cooling (150W)	200 x 10 ³ hours
continued on next page			

Specifications (measured @ $T_a = 25^\circ\text{C}$, nom. V_{in} and full load unless otherwise stated)

Notes:

Note7: Recognized by UL for safe operation up to 5000m. High altitude operation may impact the performance and lifetime. Please contact RECOM tech support for advice.

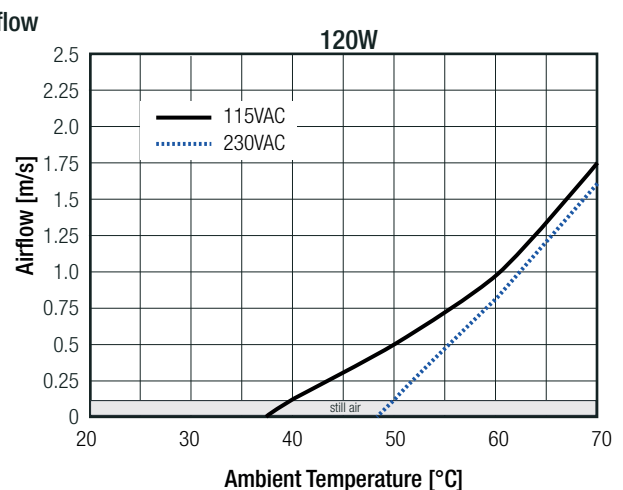
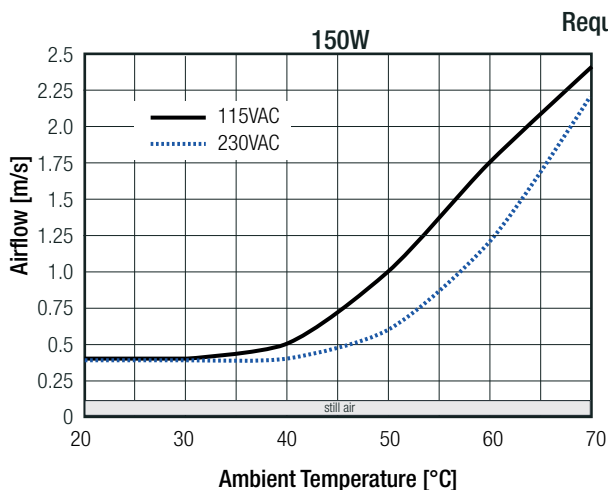
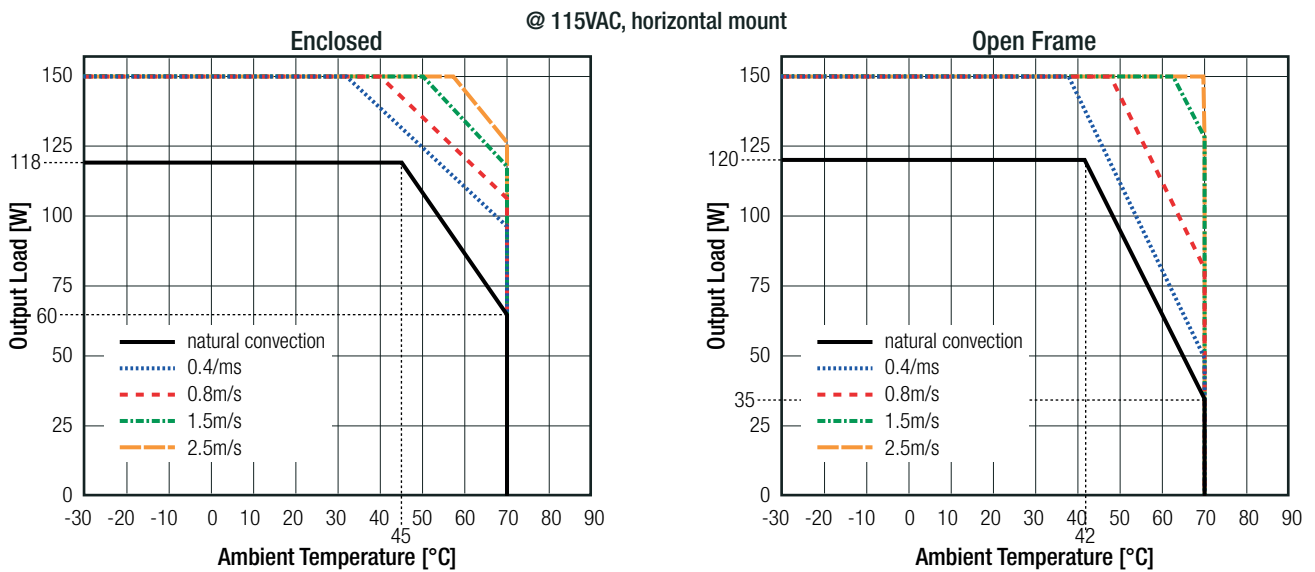
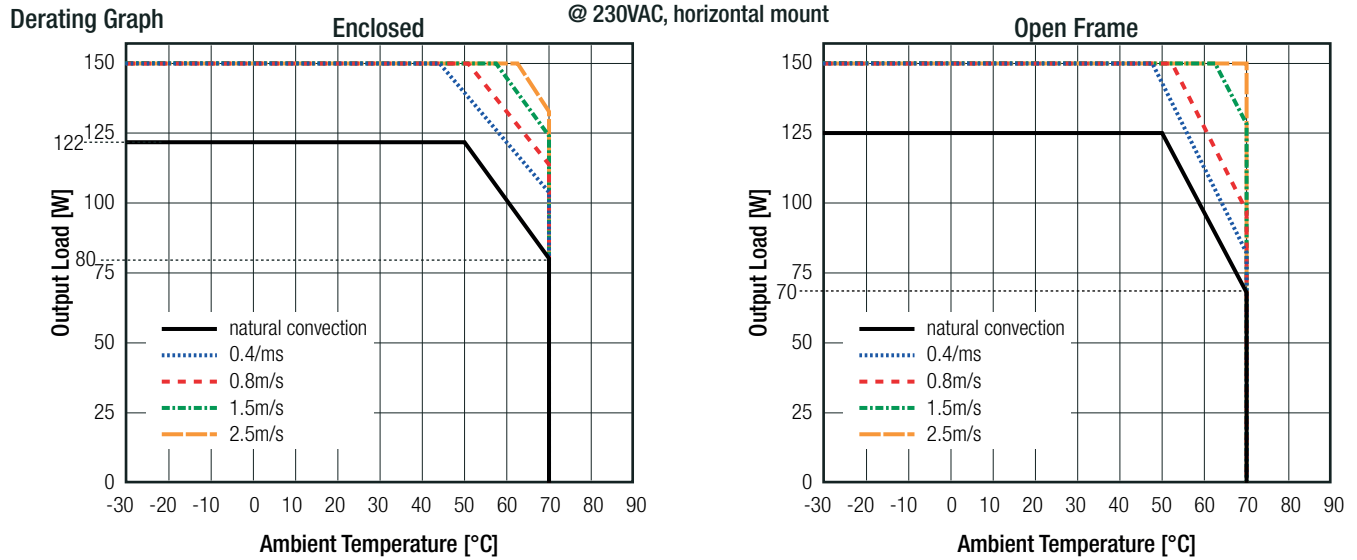

<0.1m/s = still air
0.1 - 0.2m/s = natural convection

Specifications (measured @ Ta= 25°C, nom. Vin and full load unless otherwise stated)

SAFETY AND CERTIFICATIONS		
Certificate Type (Safety)	Report / File Number	Standard
Information Technology Equipment, General Requirements for Safety	E196683 A2	CAN/CSA-C22.2 No. 62368-1-14 UL62368-1, 2nd Edition, 2014
Audio/Video, information and communication technology equipment - Part1: Safety requirements		CAN/CSA-C22.2 No. 60950-1-07, 2nd Edition, 2014 UL60950-1, 2nd Edition, 2014
Audio/Video, information and communication technology equipment - Part1: Safety requirements (CB Scheme)	16BAS07018 11	IEC60950-1:2005 2nd Edition + Am2:2013 EN60950-1:2006 + A2:2013
	16BCS07018 21	IEC62368-1:2014 2nd Edition EN62368-1:2014
EAC Safety of Low Voltage Equipment	RU-AT.49.09571	TP TC 004/2011
RoHs 2		RoHS 2011/65/EU + AM2015/863
EMC Compliance		
	Condition	Standard / Criterion
Electromagnetic compatibility of multimedia equipment – Emission Requirements	16EAS07018 11	EN55032:2010 + AC:2011, Class B
Information technology equipment - Immunity characteristics - Limits and methods of measurement		EN55024:2010+A1:2015
Limitations on the amount of electromagnetic interference allowed from digital and electronic devices		47 CFR FCC Part 15 Subpart B: 2016
ESD Electrostatic Discharge Immunity Test	air ±8.0kV, contact ±4.0kV	EN61000-4-2:2009, Criteria B
Radiated, Radio-Frequency, Electromagnetic Field Immunity Test	3.0V/m	EN61000-4-3:2006 + A2:2010, Criteria A
Fast Transient and Burst Immunity	AC Power Port: ±1.0kV	EN61000-4-4:2012, Criteria B
Surge Immunity	AC Power Port: L-N ±1.0kV, L-PE+N-PE ±2.0kV	EN61000-4-5:2014, Criteria B
Immunity to Conducted Disturbances, Induced by Radio-Frequency Fields	AC Power Port 3.0V	EN61000-4-6:2014, Criteria A
Voltage Dips and Interruption	Voltage Dips >95% Voltage Dips 30% Voltage Interruptions > 95%	EN61000-4-11:2004, Criteria B
		EN61000-4-11:2004, Criteria C
		EN61000-4-11:2004, Criteria C
Limits of Harmonic Current Emissions		EN61000-3-2:2014, Criteria A
Limits of Voltage Fluctuations & Flicker		EN61000-3-3:2013

DIMENSIONS and PHYSICAL CHARACTERISTICS		
Parameter	Type	Value
Material	PCB	FR4 (UL94-V0)
	case/baseplate	aluminium
Dimension (LxWxH)	OF -version	101.6 x 50.8 x 30.0mm
	ENC-version	105.0 x 62.0 x 35.0mm
Weight	OF -version	200.0g
	ENC-version	265.0g
continued on next page		

Specifications (measured @ Ta= 25°C, nom. Vin and full load unless otherwise stated)

Dimension Drawing Open Frame (mm)

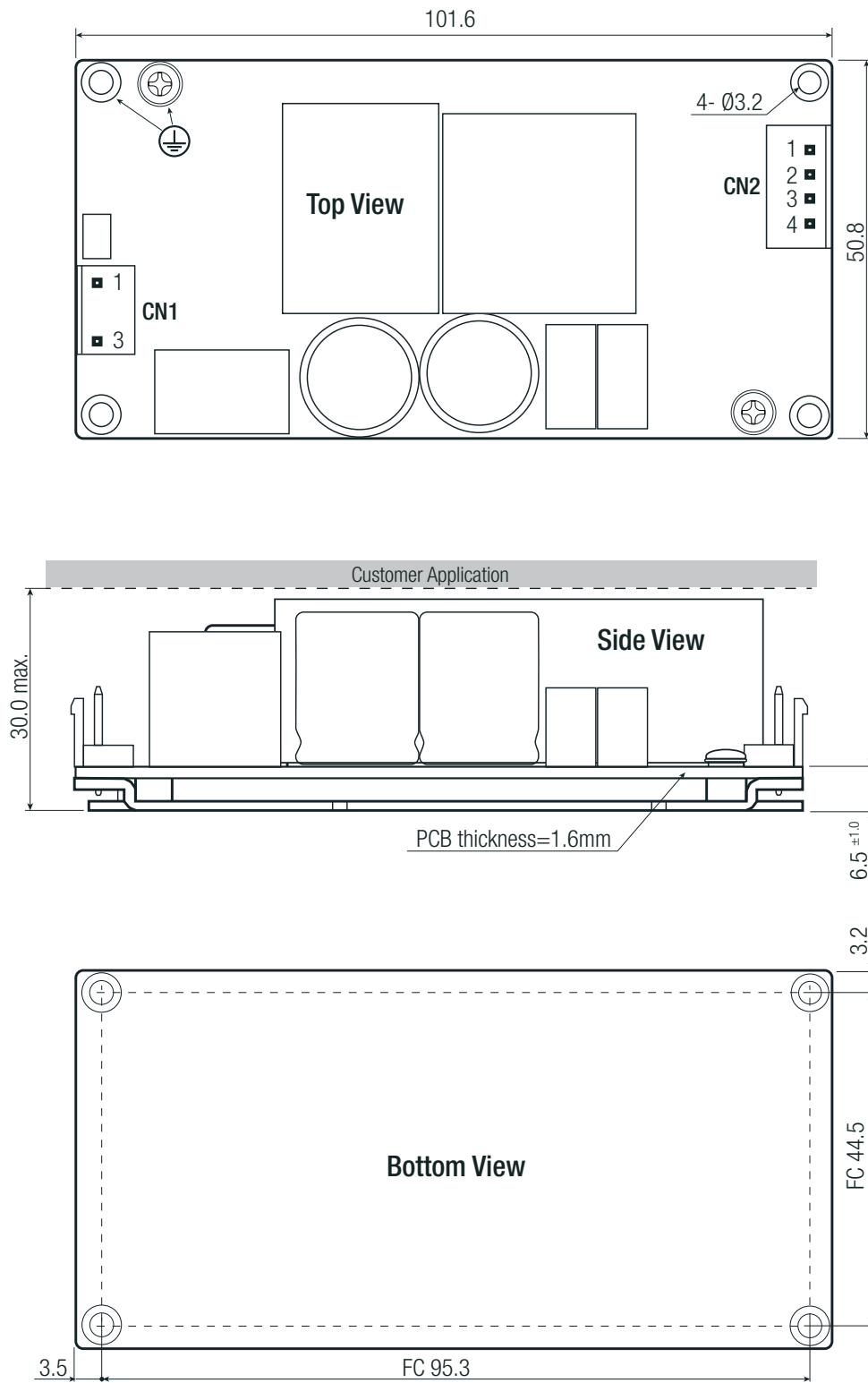

Connections

AC Input (CN1)

Pin #	Terminal
1 AC/L	3 Pins (Pin2 removed) with 3 AC/N
	3.96mm pitch

DC Output Connector (CN2)

Pin #	Terminal
1,2 V-	4 Pins with 3,4 V+
	3.96mm pitch

FC= fixing centers
Crimp Terminal AWG Range: 18-22AWG
Tolerance: xx.x= ±1.0mm
xx.xx= ±0.5mm

Compatible Connectors

Housing

Landwin 3960S Series
JST VHR
Molex 51144 Series

Crimp Terminal

Landwin 3963T011R
JST SVH-21T-P1.1
Molex 50539

continued on next page

Specifications (measured @ Ta= 25°C, nom. Vin and full load unless otherwise stated)

Dimension Drawing Enclosed Case (mm)

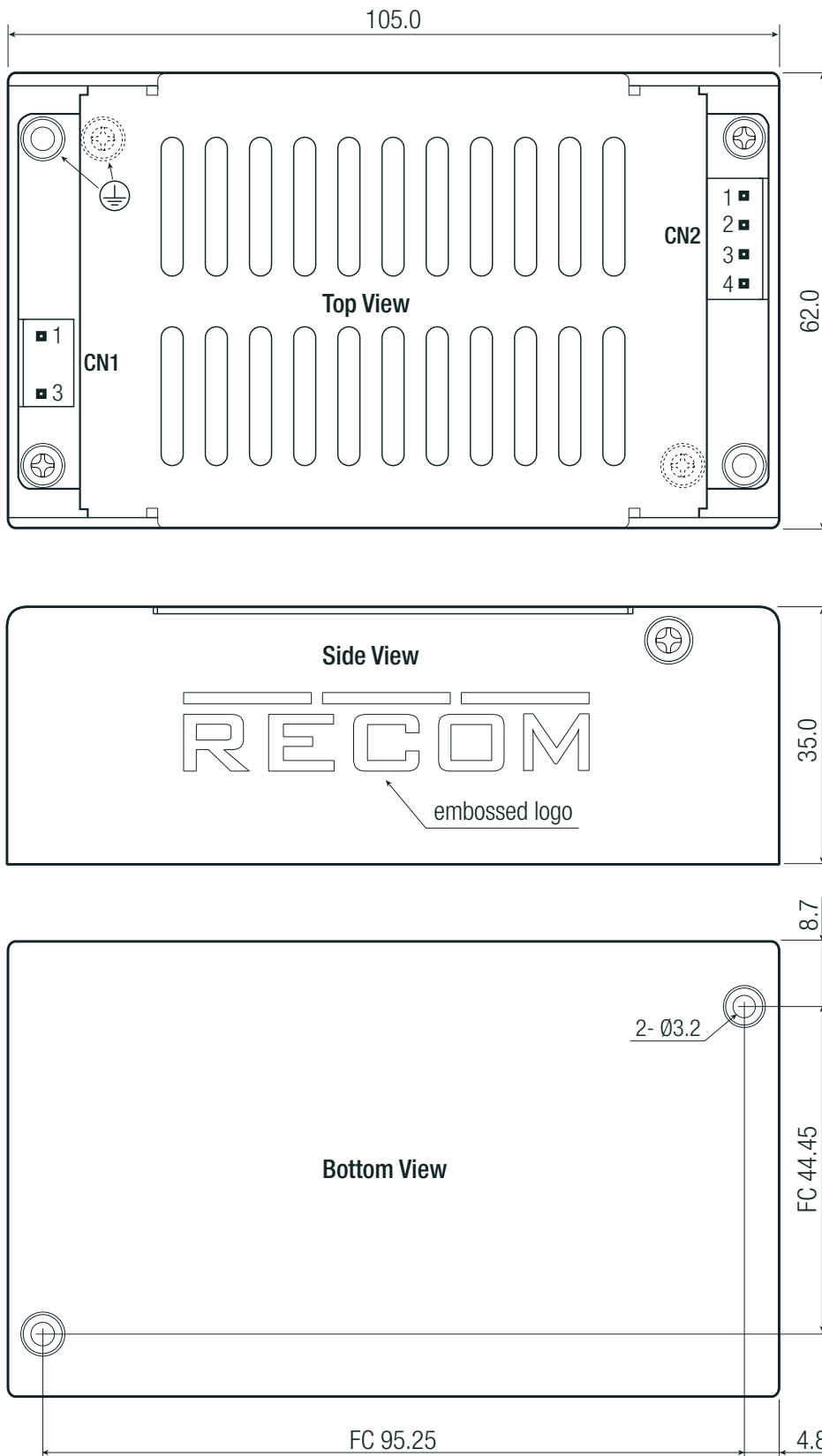

Connections

AC Input (CN1)

Pin #	Terminal
1 AC/L	3 Pins (Pin2 removed) with 3.96mm pitch
3 AC/N	

DC Output Connector (CN2)

Pin #	Terminal
1,2 V-	4 Pins with 3.96mm pitch
3,4 V+	

FC= fixing centers
Crimp Terminal AWG Range: 18-22AWG
Tolerance: xx.xx= ±1.0mm
 xx.xx= ±0.5mm

Compatible Connectors

Housing

Landwin 3960S Series
JST VHR
Molex 51144 Series

Crimp Terminal

Landwin 3963T011R
JST SVH-21T-P1.1
Molex 50539

continued on next page

Specifications (measured @ Ta= 25°C, nom. Vin and full load unless otherwise stated)

APPLICATION and INSTALLATION

Mounting

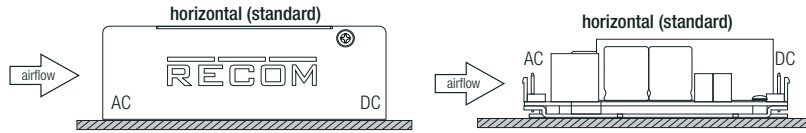

If module is mounted vertical or upside-down with natural convection cooling, the power must be derated $\geq 10\%$.

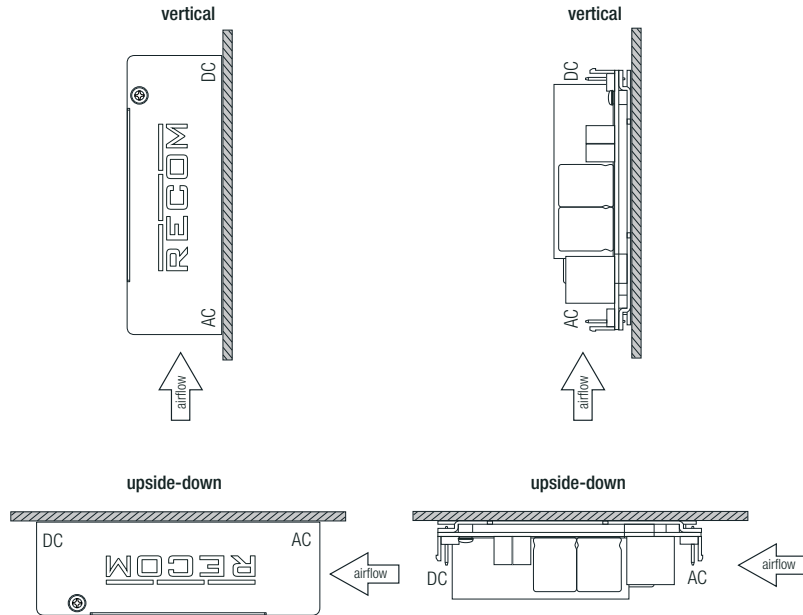

Block Diagram

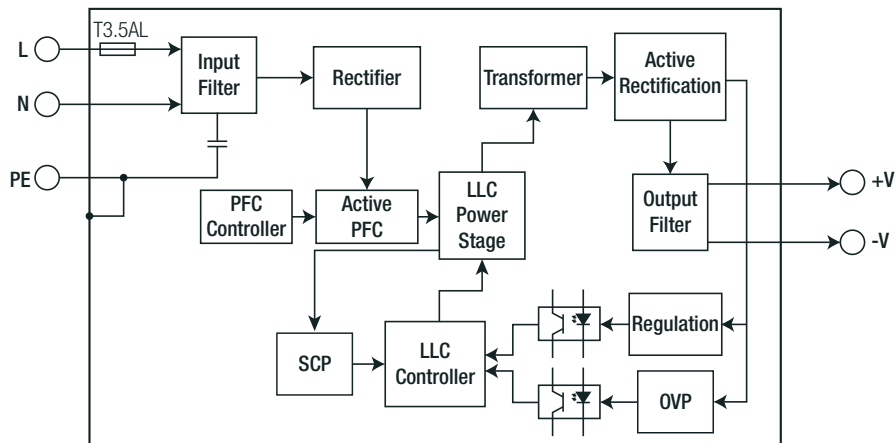

PACKAGING INFORMATION

Parameter	Type	Value
Packaging Dimension (LxWxH)	cardboard box	112.0 x 80.0 x 50.0mm
Packaging Quantity		1pcs
Storage Temperature Range		-40°C to +85°C
Storage Humidity	non-condensing	10% - 95% RH

The product information and specifications may be subject to changes even without prior written notice. The product has been designed for various applications; its suitability lies in the responsibility of each customer. The products are not authorized for use in safety-critical applications without RECOM's explicit written consent. A safety-critical application is an application where a failure may reasonably be expected to endanger or cause loss of life, inflict bodily harm or damage property. The applicant shall indemnify and hold harmless RECOM, its affiliated companies and its representatives against any damage claims in connection with the unauthorized use of RECOM products in such safety-critical applications.