

Current Transducer LDSR 0.3-NP

$$I_{PRN} = 300 \text{ mA}$$

For the electronic measurement of current: DC, AC, pulsed..., with galvanic separation between the primary and the secondary circuit.

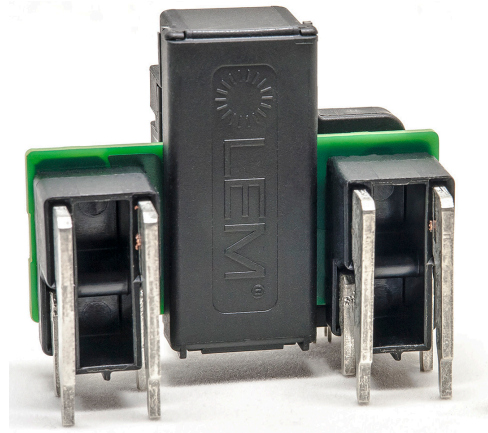

Features

- Closed loop (compensated) current transducer
- Voltage output
- Single supply voltage
- PCB mounting.

Special feature

- Dedicated primary PCB.

Advantages

- Very low offset drift temperature coefficient
- High overload capability
- High insulation capability
- Reference pin with two modes, Ref IN and Ref OUT
- Test winding.

Applications

- Leakage current measurement in transformerless PV inverters
- 3 phases plus neutral
- First human contact protection of PV arrays
- Failure detection in power sources
- Symmetrical fault detection
- Current leakage detection in stacked DC sources
- Nominal current per phase measurement up to ± 30 A per wire (DC or AC).

Standards

- EN 61800-1: 1997
- EN 61800-2: 2015
- EN 61800-3: 2004
- UL 62109-1: 2010
- IEC 61010-1: 2010
- UL 508.

Application Domain

- Industrial.

Absolute maximum ratings

Parameter	Symbol	Unit	Value
Maximum supply voltage	$U_{C\max}$	V	7
Maximum primary conductor temperature	$T_{B\max}$	°C	110
Overload capability	\hat{I}_P		3300

Stresses above these ratings may cause permanent damage. Exposure to absolute maximum ratings for extended periods may degrade reliability.

UL 508: Ratings and assumptions of certification

File # E189713 Volume: 2 Section: 11

Standards

- CSA C22.2 NO. 14-10 INDUSTRIAL CONTROL EQUIPMENT - Date 2011/08/01
- UL 508 STANDARD FOR INDUSTRIAL CONTROL EQUIPMENT - Date 2013

Ratings

Parameter	Symbol	Unit	Value
Primary involved potential		V RMS	300
Max surrounding air temperature	T_A	°C	105
Primary current	I_P	A	30
Secondary supply voltage	U_C	V DC	5
Output voltage	U_{out}	V	0 to 5

Conditions of acceptability

When installed in the end-use equipment, consideration shall be given to the following:

- 1 - These devices must be mounted in a suitable end-use enclosure.
- 2 - The terminals have not been evaluated for field wiring.
- 3 - The LDSR xx-NP Series shall be used in a pollution degree 2 environment or better.
- 4 - Low voltage circuits are intended to be powered by a circuit derived from an isolating source and having no direct connection back to the primary circuit.
- 5 - These devices are intended to be mounted on the printed wiring board of the end-use equipment (with a minimum CTI of 100).
- 6 - LDSR xx-NP Series: based on results of temperature tests, in the end-use application, a maximum of 110°C cannot be exceeded on the primary jumper.

Marking

Only those products bearing the UL or UR Mark should be considered to be Listed or Recognized and covered under UL's Follow-Up Service. Always look for the Mark on the product.

Insulation coordination

Parameter	Symbol	Unit	Value	Comment
RMS voltage for AC insulation test, 50 Hz, 1 min	U_d	kV	1.71	According to 62109-1
Impulse withstand voltage 1.2/50 μ s	U_{Ni}	kV	4	
Partial discharge extinction RMS voltage @ 10 pC	U_e	V	990	
Clearance (pri. - sec.)	d_{Cl}	mm	See outline drawing in page 10	
Creepage distance (pri. - sec.)	d_{Cp}			
Case material	-	-	V0	according to UL 94
Comparative tracking index	CTI		600	

Environmental and mechanical characteristics

Parameter	Symbol	Unit	Min	Typ	Max	Comment
Ambient operating temperature	T_A	$^{\circ}$ C	-40		105	
Ambient storage temperature	T_S	$^{\circ}$ C	-50		105	
Mass	m	g		38		

Electrical data

At $T_A = 25\text{ °C}$, $U_C = +5\text{ V}$, unless otherwise noted. (See Min, Max, typ. definition paragraph in page 7).
 Lines with * in the condition column apply over the ambient temperature range.

Parameter	Symbol	Unit	Min	Typ	Max	*	Comment
Primary nominal residual RMS current	I_{PRN}	mA		300		*	
Primary residual current, measuring range	I_{PRM}	mA	-900		900	*	
Supply voltage	U_C	V	4.75	5	5.25	*	
Current consumption	I_C	mA		18	20.5		$+I_P\text{ (mA)}/N_S$ with $N_S = 40$ turns
Internal voltage reference	U_{Iref}	V	2.485	2.5	2.515		
Internal voltage source current reference	I_{Iref}	μA			400		
External voltage reference	U_{Eref}	V	2.25		2.75		
Current to force a voltage external reference	-	mA			1.5		
Electrical offset current referred to primary	I_{OE}	mA	-40		40		
Temperature coefficient of I_{OE} @ $I_P = 0\text{ A}$	TCl_{OE}	$\text{mA}/\text{°C}$	-0.40	± 0.17	0.40		
Magnetic offset after $1000 \times I_{PN}$	I_{OM}	mA		8			
Theoretical sensitivity	S_N	V/A		2.22			
Sensitivity error	ε_S	%	-2		2		For $R_L > 500\text{ k}\Omega$
Temperature coefficient of S	TCS	ppm/K			± 250		
Linearity error	ε_L	% of I_{PRN}	-3		3		
RMS noise current 1 Hz ... 2 kHz referred to primary	I_{no}	mA		7.5			
Delay time @ 10 % of I_{PN}	t_{D10}	μs		25			For $R_L > 500\text{ k}\Omega$; $di/dt = 3\text{ mA}$
Delay time @ 90 % of I_{PN}	t_{D90}	μs		300			For $R_L > 500\text{ k}\Omega$; $di/dt = 3\text{ mA}$
Start-up time	t_{start}	ms		220			
Frequency bandwidth (-3 dB)	BW	kHz	mA	2			For $R_L > 500\text{ k}\Omega$
Sum of sensitivity and linearity	ε_{SL}		-40		40	*	Without initial offset
Sum of sensitivity and linearity	ε_{SL}		-8		8		For $\pm 30\text{ mA}$ instantaneous DC jump
Sum of sensitivity and linearity	ε_{SL}		-12		12		For $\pm 60\text{ mA}$ instantaneous DC jump
Sum of sensitivity and linearity	ε_{SL}		-20		20		For $\pm 150\text{ mA}$ instantaneous DC jump
Degauss time		ms		120			
Degauss pin going voltage	IN Low	V			1.62		
	IN High	V	3.42				
	Pulse duration	ms	0.6				

Performance parameters definition

Transducer simplified model

The static model of the transducer at temperature T_A is:

$$U_{out} = S \cdot I_p + \varepsilon$$

In which $\varepsilon =$

$$U_{OE} + U_{OT}(T_A) + \varepsilon_S \cdot I_p \cdot S + \varepsilon_L(I_{PRM}) \cdot I_{PRM} \cdot S + TCS \cdot (T_A - 25) \cdot I_p \cdot S$$

- With:
- $I_{PRM \max}$: max primary residual measuring range applied to the transducer
 - U_{out} : output voltage (V)
 - T_A : ambient operating temperature (°C)
 - U_{OE} : electrical offset voltage (V)
 - $U_{OT}(T_A)$: temperature variation of U_O at temperature T_A (°C)
 - S : sensitivity of the transducer (V/At)
 - TCS : temperature coefficient of S
 - ε_S : sensitivity error
 - $\varepsilon_L(I_{PRM})$: linearity error for $I_{PRM \max}$

This model is valid for primary ampere-turns I_p between $-I_{PRM}$ and $+I_{PRM}$ only.

Pre-conditioning

Before any test measure the transducer is pre conditioned by applying calibrated differential current cycles.

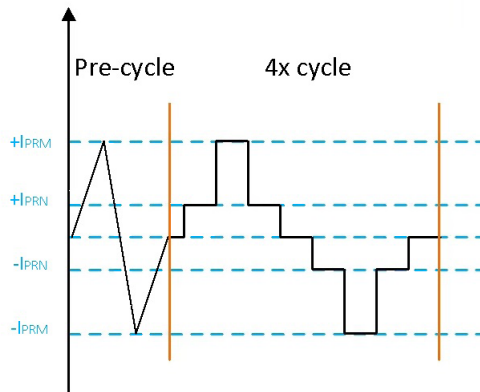

Figure 1: Pre-conditioning differential current cycles

Sensitivity and linearity

To measure sensitivity and linearity, the primary current (DC) is cycled from 0 to I_{PRM} then to $-I_{PRM}$ and back to 0 (equally spaced $I_{PRM}/10$ steps). The sensitivity S is defined as the slope of the linear regression line for a cycle between $\pm I_{PRN}$. The linearity error ε_L is the maximum positive or negative difference between the measured points and the linear regression line, expressed in % of I_{PRM} .

Degauss

A rising edge on the “Degauss” pin will initiate the degauss cycle. During the cycle the output U_{out} does not carry relevant information.

- Notes:
- 1) a degauss cycle is automatically initiated at power up
 - 2) the “Degauss” pin is provided with a 10 kΩ pull down resistor and can be left unconnected.

The figure below describes the expected output during a degauss session.

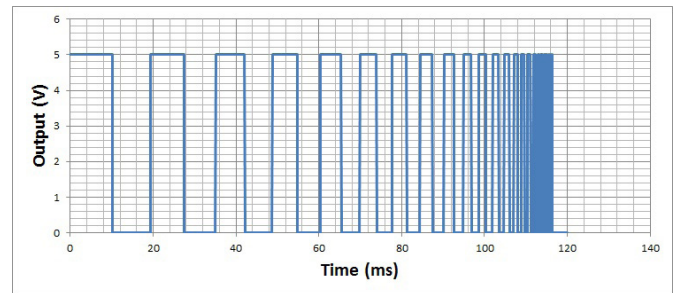

Magnetic offset

The magnetic offset current I_{OM} is the consequence of a current on the primary side (“memory effect” of the transducer’s ferromagnetic parts). It is measured using the following primary current cycle. I_{OM} depends on the current value I_{P1} ($I_{P1} > I_{PM}$).

$$I_{OM} = \frac{I_S(t_1) - I_S(t_2)}{2} \cdot \frac{1}{S}$$

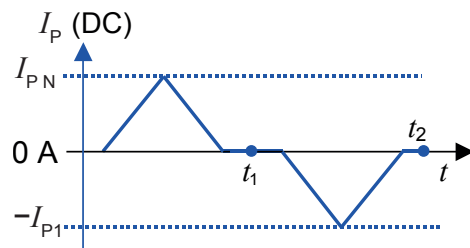

Figure 1: Current cycle used to measure magnetic and electrical offset (transducer supplied)

Performance parameters definition

Electrical offset

The electrical offset current I_{OE} can either be measured when the ferro-magnetic parts of the transducer are:

- completely demagnetized, which is difficult to realize,
- or in a known magnetization state, like in the current cycle shown in figure number.

Using the current cycle shown in figure ..., the electrical offset is:

$$I_{OE} = \frac{I_{out}(t_1) + I_{out}(t_2)}{2}$$

The temperature variation I_{OT} of the electrical offset current I_{OE} is the variation of the electrical offset from 25 °C to the considered temperature:

$$I_{OT}(T) = I_{OE}(T) - I_{OE}(25^\circ C)$$

Note: the transducer has to be demagnetized prior to the application of the current cycle (for example with a demagnetization tunnel).

Total error referred to primary

The total error at 25 °C ϵ_{tot} is the error in the $-I_{PN} \dots +I_{PN}$ range, relative to the rated value I_{PN} .

It includes:

- the electrical offset I_{OE}
- the sensitivity error ϵ_s
- the linearity error ϵ_L (to I_{PN})

Delay times

The delay time t_{D10} @ 10 % and the delay time t_{D90} @ 90 % are shown in figure 2.

Both slightly depend on the primary current di/dt . They are measured at nominal current.

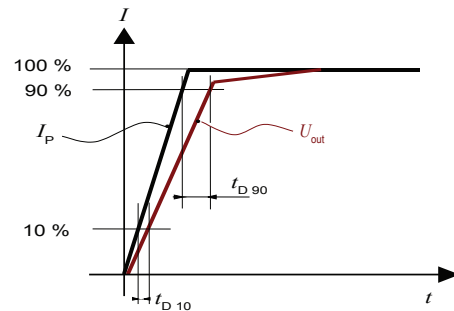

Figure 2: t_{D10} (delay time @ 10 %) and t_{D90} (delay time @ 90 %)

Application information

Decoupling supply voltage U_c (5 V):

LDSR transducers are already provided with internal decoupling capacitors.

Depending on the design it is advisable to add an external decoupling: 1 μ F or more.

If fast differential current surges are to be expected the decoupling capacitor should be increased in order to absorb the energy from internal protection diodes.

In this case the capacitor should be increased to more than 10 μ F.

Protection of test winding:

If fast differential current surges are to be expected, the circuit connected to the test winding shall be protected to absorb the energy coupled from the primary surge.

Load on U_{out} :

The maximum U_{out} current is 10 mA. The load on this output should be adapted to not exceed this current.

Decoupling reference U_{ref} :

The maximum decoupling capacitor value is 47 nF.

Output U_{out} properties:

The output is a direct operational amplifier output. The output current is limited to 10 mA.

Using an external reference voltage:

If the U_{ref} pin of the transducer is not used it could be either left unconnected or filtered according to the previous paragraph "Reference U_{ref} ".

If an external voltage reference is used its source capability must be at least 1.5 mA.

Definition of typical, minimum and maximum values

Minimum and maximum values for specified limiting and safety conditions have to be understood as such as well as values shown in "typical" graphs.

On the other hand, measured values are part of a statistical distribution that can be specified by an interval with upper and lower limits and a probability for measured values to lie within this interval. Unless otherwise stated (e.g. "100 % tested"), the LEM definition for such intervals designated with "min" and "max" is that the probability for values of samples to lie in this interval is 99.73 %. For a normal (Gaussian) distribution, this corresponds to an interval between -3 sigma and $+3$ sigma.

If "typical" values are not obviously mean or average values, those values are defined to delimit intervals with a probability of 68.27 %, corresponding to an interval between $-\text{sigma}$ and $+\text{sigma}$ for a normal distribution.

Typical, maximal and minimal values are determined during the initial characterization of the product.

Primary nominal residual current and primary nominal current

The primary nominal residual current is the sum of the instantaneous values of all currents flowing through the primary circuit of the transducer.

The presence of a primary nominal current DC or AC may lead to an additional uncertainty.

For example, with a primary nominal current of 30 A the uncertainty is typically 1.2 % of the primary nominal residual current (1.2 % of 300 mA giving 3.6 mA).

Test LDSR transducer

Twenty turns are available on the magnetic core in order to perform tests. The current is limited to 50 mA.

PCB footprint according to the product

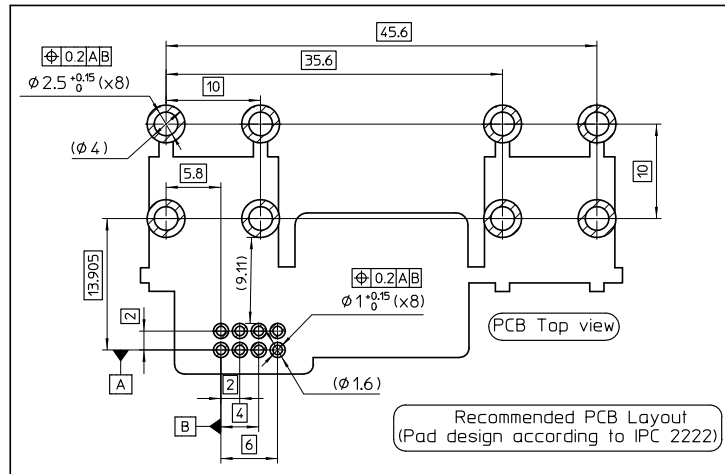

Note: the dimension of customer PCB tracks (width & thickness) and the LEM transducer's primary PCB are linked and can influence on each other temperature heating.

Assembly on PCB

- Recommended PCB hole diameter
 - ϕ 2.9 mm for primary pin
 - ϕ 1 mm for secondary pin
- Maximum PCB thickness
 - 2.4 mm
- Wave soldering profile
 - maximum 260 °C, 10 s
 - No clean process only

Safety

This transducer must be used in limited-energy secondary circuits according to IEC 61010-1.



This transducer must be used in electric/electronic equipment with respect to applicable standards and safety requirements in accordance with the manufacturer's operating instructions.



Caution, risk of electrical shock

When operating the transducer, certain parts of the module can carry hazardous voltage (e.g. primary busbar, power supply).

Ignoring this warning can lead to injury and/or cause serious damage.

This transducer is a build-in device, whose conducting parts must be inaccessible after installation.

A protective housing or additional shield could be used. Main supply must be able to be disconnected.



ESD susceptibility

The product is susceptible to be damaged from an ESD event and the personnel should be grounded when handling it.



Underwriters Laboratory Inc. recognized component

Remark

Installation of the transducer must be done unless otherwise specified on the datasheet, according to LEM Transducer Generic Mounting Rules. Please refer to LEM document N°ANE120504 available on our Web site: www.lem.com/en/file/3137/download.

Dimensions (in mm)

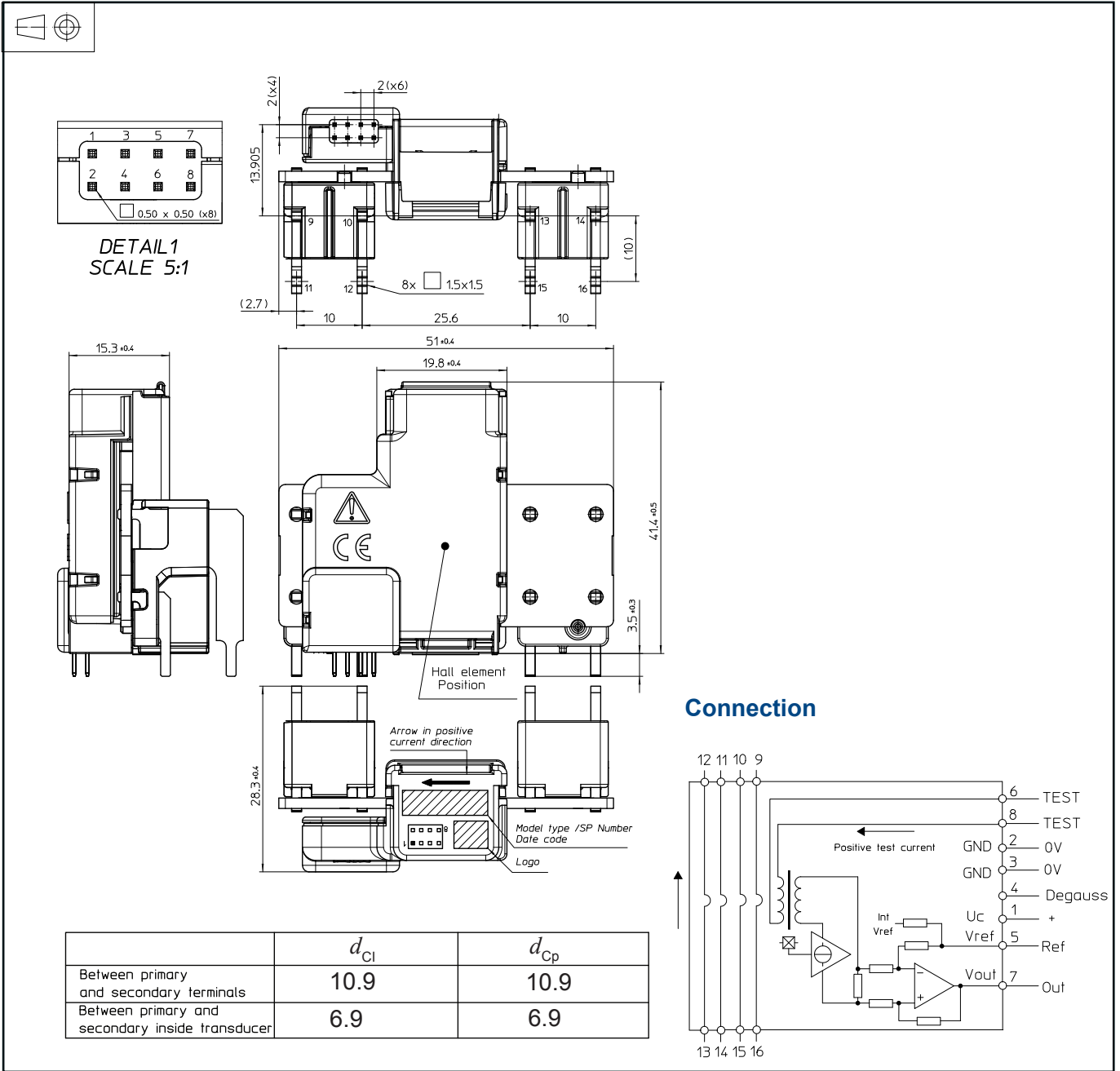

Creepage and Clearance

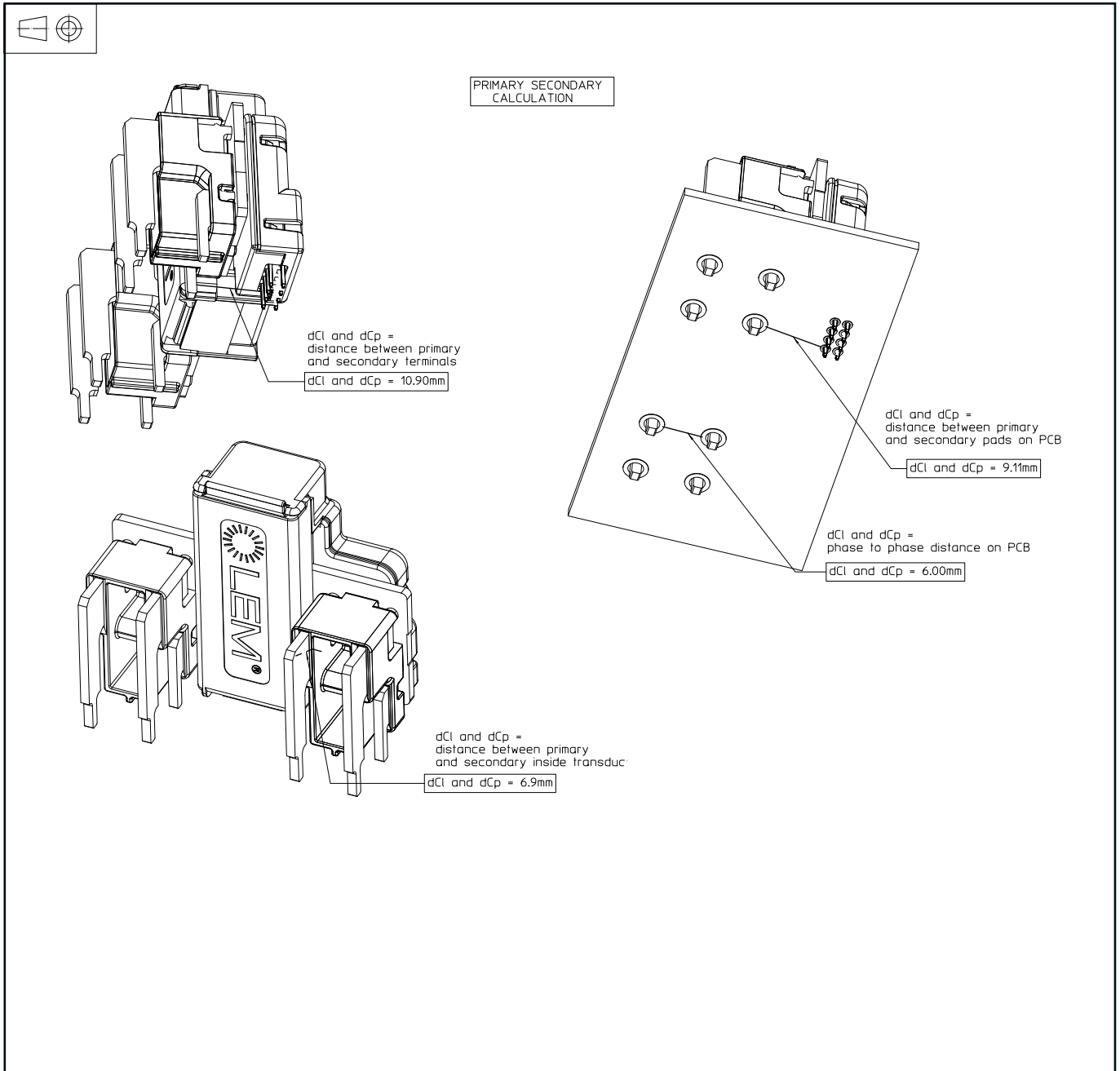

Packaging information

Standard delivery in cardboard: L × W × H: 300 × 200 × 200 mm

Each cardboard contains 60 parts, placed into 3 Polystyrene-made trays of 20 parts each one.

Both trays and cardboard are ESD-compliant.

The typical weight of the cardboard is 2.5 Kg.

